

Configuration and diagnostics for UNIFREM and QUATROFREM (output side) frequency converters



VONSCH s.r.o.
Budovateľská 13
BREZNO, 977 01 Slovakia

tel.: +421 048 / 612 29 44
612 27 96
fax.: +421 048 / 671 30 20

vonsch@vonsch.sk
www.vonsch.sk

1 Contents

2	Structure and types of parameters in the document.....	7
2.1	Defining the meaning and type of parameters in part DIAGNOSTICS.....	7
2.2	Defining the meaning and type of parameters in part SETTINGS.....	8
2.3	Type of parameters defining in the part SAVE / RESTORE.....	13
3	Range of parameters by product type.....	14
3.1	Undervoltage, overvoltage.....	14
3.2	Temperatures.....	14
4	DIAGNOSTICS.....	15
4.1	Command.....	15
4.2	Control.....	15
4.2.1	Power and energy.....	16
4.2.2	Additional quantities.....	16
4.2.3	Positioning.....	17
4.3	Inputs and outputs.....	18
4.3.1	BIN.....	18
4.3.2	AIN.....	18
4.3.3	RELAYS.....	18
4.3.4	AOOUT.....	19
4.3.5	IRC.....	19
4.3.6	ARC.....	20
4.4	Functions.....	21
4.4.1	PLC function.....	21
4.4.2	Limit switches.....	21
4.4.3	Process controller.....	22
4.4.4	Optimization.....	22
4.4.5	Lifting functions.....	22
4.4.6	Pantograph/isol. monitor.....	23
4.4.7	Ext. thermal protection.....	23
4.4.8	Differential.....	23
4.5	Converter state.....	24
4.6	Thermal protections.....	24
4.7	Communication.....	25
4.7.1	MODBUS.....	25
4.7.2	PROFIBUS.....	26
4.7.3	RS LINKS.....	27
4.8	SW and HW version.....	27
4.9	Date and Time.....	27
5	WARNINGS.....	28
6	ERRORS.....	32
7	SETTINGS.....	35
7.1	Using the quick setup wizard with VONSCH UNIFREM.....	35
7.1.1	Working with the wizard.....	35
7.1.2	Steps of the quick setup wizard.....	36
7.1.3	Setting the motor data, application and command macro.....	37
7.1.4	Application macros.....	38
7.1.5	Command macros.....	39
7.1.6	Directions and the encoder.....	40
7.1.7	Control methods, parameter identification, dynamics of the drive.....	41
7.2	MOTOR.....	42
7.2.1	MOTOR MACROS.....	43
7.2.2	IDENTIFICATION.....	43
7.2.3	NAMEPLATE MOTOR PARAMETERS.....	43
7.2.4	ELECTRICAL PARAMETERS OF THE MOTOR.....	44
7.2.5	MECHANICAL PARAMETERS.....	46

7.2.6	SERVOMOTOR (SMPM).....	47
7.3	CONVERTER PARAMETERS.....	47
7.3.1	APPLICATION MACROS	47
7.3.2	ENERGY CONS.....	48
7.4	COMMANDS	48
7.4.1	COMMAND MACROS	48
7.4.2	START STOP RESET	49
7.4.3	FREQUENCY SETPOINT	51
7.4.4	TORQUE SETPOINT.....	52
7.4.5	POSITION SETPOINT.....	53
7.4.6	DISCRETE SETPOINTS	54
7.4.7	UP/DOWN COMMANDS	56
7.4.8	AUTO OFF	57
7.5	CONTROL AND REGULATION	57
7.5.1	CONTROL METHOD.....	57
7.5.2	V/f CONTROL	58
7.5.3	VECTOR CONTROL	63
7.5.4	FREQUENCY RAMPS.....	72
7.5.5	MAXIMUM CURRENT AND VOLTAGE	75
7.5.6	FLYING START	75
7.5.7	VOLTAGE CONTROLLER (VC).....	76
7.5.8	BRAKE MODULE.....	77
7.5.9	FLUX BRAKING.....	77
7.5.10	POWER RESTRICTION	78
7.6	INPUTS AND OUTPUTS	79
7.6.1	BINARY INPUTS.....	79
7.6.2	ANALOG INPUTS.....	80
7.6.3	RELAY OUTPUTS	84
7.6.4	ANALOG OUTPUTS.....	87
7.6.5	IRC	88
7.6.6	IRC2/ARC.....	89
7.7	FUNCTIONS.....	89
7.7.1	PLC FUNCTIONS	89
7.7.2	LIMIT SWITCHES	101
7.7.3	PROCESS CONTROLLER.....	103
7.7.4	OPTIMIZATION.....	106
7.7.5	MECHANICAL BRAKE	108
7.7.6	LIFTING FUNCTIONS	109
7.7.7	EXTERNAL THERMAL PROTECTION (ETP)	111
7.7.8	IRC1,2 DIFFERENCE.....	112
7.7.9	DIFFERENTIAL.....	113
7.8	FAULTS AND WARNINGS	113
7.8.1	OPTIONAL FAULTS	114
7.8.2	ENC. FAULTS.....	115
7.8.3	FAULT ACKNOWLEDGEMENT.....	116
7.8.4	QUANTITIES TO LOG.....	117
7.8.5	WARNINGS	117
7.9	DISPLAY.....	118
7.9.1	DISP. QUANT. SETTINGS	118
7.9.2	MONITOR SETTING	119
7.10	COMMUNICATION.....	119
7.10.1	MODBUS.....	119
7.10.2	PROFIBUS.....	122
7.11	PAR. SETS	124
7.11.1	SET SWITCH.....	124
7.11.2	USER SETS.....	125
8	Converter function configuration manual	134

8.1	Production (factory) settings	134
8.2	Motor parameters – MOTOR MACROS – identification.....	134
8.3	Motor control modes.....	135
8.3.1	V/f control	136
8.3.2	V/f curve	137
8.3.3	IR compensation	139
8.3.4	Starting Torque Controller (STC).....	140
8.3.5	Slip compensation.....	141
8.4	Maximal current controller (MCC).....	142
8.5	Resonance damping	145
8.6	Voltage controller (VC) - Dynamic deceleration (DD) a Kinetic backup (KB).	147
8.7	Flux braking.....	149
8.8	Flying start.....	150
8.9	Power restriction.....	151
8.10	Optimization	152
8.11	External thermal protection (ETP).....	155
8.12	Overload switch „OPS“	157
8.13	Dynamic lift (DL) function	160
8.14	IRC detuning function	162
8.15	Using the parameter set switching for a special behavior of converter functions	164
9	UNIFREM Frequency converter settings examples.....	168
9.1	Process controller - PC setting to control the level height in the tank.....	168
9.1.1	Situation	168
9.1.2	Converter connection.....	168
9.1.3	Analog inputs setting.....	168
9.1.4	Process controller setting.....	168
9.1.5	Converter output setting.....	169
9.1.6	Monitoring.....	169
9.2	Example of logical blocks setting	170
10	Control panel – Unipanel user manual	175
10.1	Buttons.....	175
10.2	Panel start.....	176
10.3	Display	176
10.4	Converter status	176
10.5	Main menu F1	176
10.6	Monitor, monitor detail	179
10.7	Parameters setting.....	180
10.8	Graph	183
10.9	Parameter search	185
10.10	Device selection for control panel	186



WARNING

This manual dedicates to the parameters and options of VONSCH UNIFREM frequency converter settings and diagnostics.

2 Structure and types of parameters in the document

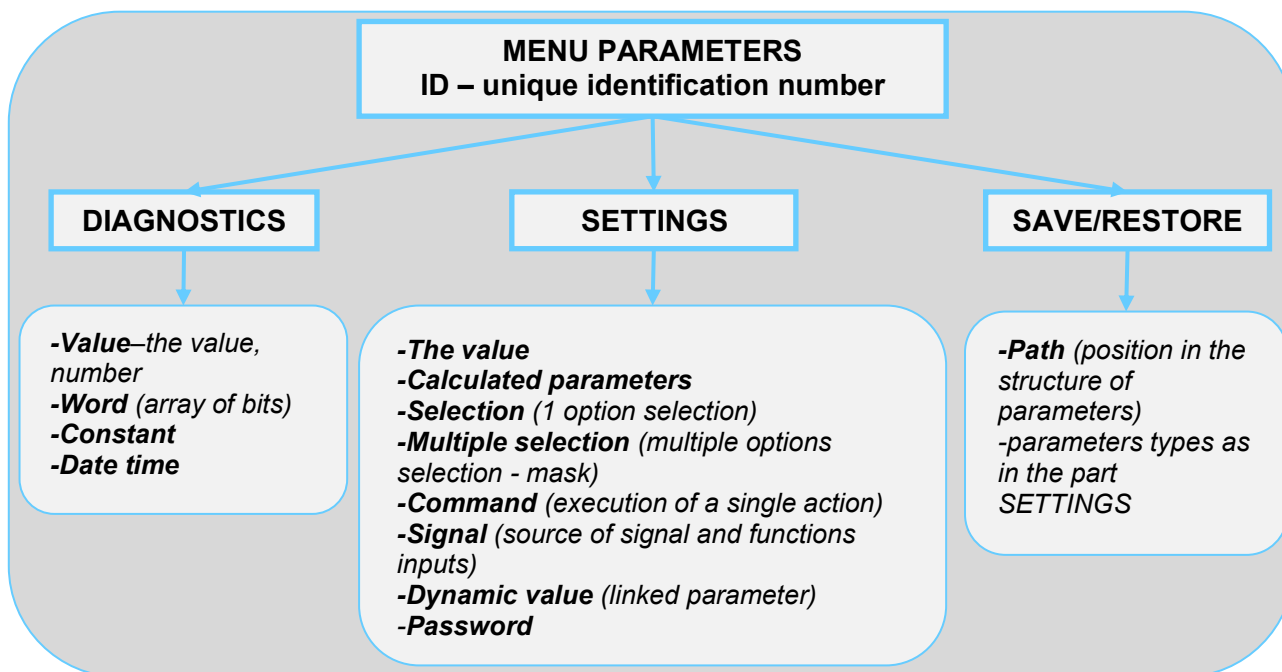

2.1 Defining the meaning and type of parameters in part DIAGNOSTICS

Parameter type: VALUE

Diagnostic parameter that displays the value of signal in physical units or in relative units or discrete number of sequences, steps, received data etc.

Position of the parameter in a tree hierarchical parameters structure

Name [ID]	Unit	Description
AIN1 Rel. [41]	%	Value of the signal connected to the analog input terminals + X1:11 and - X1:12. Parameters of the analog input can be configured in the parameter group P[147] AIN1.

Values ID and name Value unit The basic diagnostics information about the importance of value

EXAMPLE:

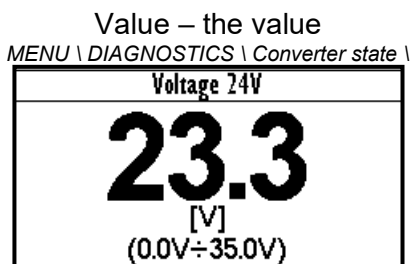

Example for value diagnostics – the value display

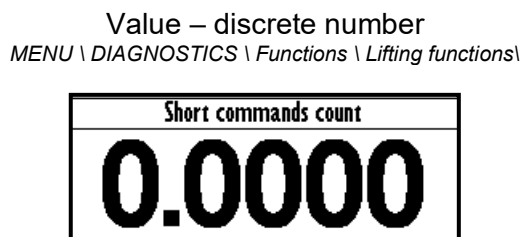

Example of diagnostic value representing the number of illegal control drive sequences

Parameter type: WORD

Individual word bits status diagnostics. Each bit represents the status of one flag of a specific function or converter mode.

The basic diagnostic information about the importance of word

MENU \ DIAGNOSTICS \ Functions \ Lifting function

Name [ID]	Unit	Description
OPS status [856]		Indicates the status of the OPS switch block.
Reset		RESET signal of the OPS is active.
Detection		Autodetection of the overload limits is running.
Overload		Overload occurred. Operation in the positive direction (up) is blocked.
Tipping		Too many forbidden tipping control commands.
Settling		Drive operates in static mode.
Dynamics		Drive operates in dynamic mode.

Individual word bits description

Additional diagnostic information about word bits view, status of word bits view, respectively meaning of word bits

EXAMPLE:

MENU \ DIAGNOSTICS \ Command \

Control word	
CONFIRM ERROR	<input type="checkbox"/>
ERR_MASTER	<input type="checkbox"/>
COMPENSATION DT	<input checked="" type="checkbox"/>
SCALAR / VECTOR	<input type="checkbox"/>
UNF BOARD TYPE	<input checked="" type="checkbox"/>

Converter control signals diagnostics

MENU \ DIAGNOSTICS \ Inputs / outputs \ Relay

Relay	
RELAY1	<input type="checkbox"/>
RELAY2	<input type="checkbox"/>
RELAY3	<input checked="" type="checkbox"/>

Output relays status diagnostics

Parameter type: CONSTANT

Diagnostic information, which takes a fixed value.

MENU \ DIAGNOSTICS \ SW and HW version \

Name [ID]	Unit	Description
SW Version [379]		Converter SW version

Constant description

EXAMPLE:

SW Version
2.100

Constant

Parameter type: DATE TIME

Diagnostic value of the date or time format.

MENU \ DIAGNOSTICS \

Date
2013/04/04

MENU \ DIAGNOSTICS \

Time
14:28:50

2.2 Defining the meaning and type of parameters in part SETTINGS

Parameter type: THE VALUE

Possibility of parameter value setting in absolute or relative units.

Basic information about the importance of the parameter

MENU \ SETTINGS \ MOTOR \

Name [ID]	Description	Def.
Nom. Current [151]	Nominal motor current, read from the nameplate or catalog data.	2.80 A
0.01 A ÷ 1000.00 A	This parameter determines the value of permanent motor current for motor overload protection P[27] Motor overloading.	

Range of the value, that parameter can take Min ÷ Max

Additional information about the importance of the parameter

The default value of the parameter – The value that is set at factory settings restoration

EXAMPLE:

MENU \ SETTINGS \ MOTOR \

Nom. current Set 4

1.03

[A]
(0.01A ÷ 1000A)

Motor current value setting

Nom. voltage

400.0

[V]
(1.0V ÷ 1000V)

Nominal motor voltage value setting

Parameter type: CALCULATED PARAMETER

Parameter, that is derived by calculation based on the values of other parameters.

MENU \ SETTINGS \ MOTOR \ SPECIAL PARAMETERS \

Name [ID]	Description	Def.
Nr of motor poles [1049]	Number of motor poles calculated from the nominal rpms and the motor frequency.	
2 ÷ 1000		

Additional information about derivation of parameter calculation

EXAMPLE:

MENU \ SETTINGS \ MOTOR \ SPECIAL PARAMETERS \

Nom. slip freq.

1.67

[Hz]
(-300.0Hz ÷ 300.0Hz)

Example of the calculated parameter

Parameter type: SELECTION

Type of parameter with option to select only one setting option (alternative).

Basic information about type of parameter - selection

MENU \ SETTINGS \ COMMANDS \ START STOP RESET \

Name [ID]	Description	Def.
Start source [194]	Setting the converter start source. The START command generates the desired voltage and frequency on the U,V,W outputs (or U,V for a single phase load).	BIN1
Control panel	Pressing the green START button on the control panel causes the converter to start. The start is canceled by pressing the red STOP button.	
Permanent start	The converter starts immediately after the switch on.	
BIN1	The converter start after the activation of the 1st binary input.	
BIN5	The converter starts after the activation of the 5th binary input.	
BIN6	The converter starts after the activation of the 6th binary input.	
MODBUS	The converter start is controlled over the serial communication. See the MODBUS serial communication protocol.	
PROFIBUS	The converter start is controlled over the serial communication. See the PROFIBUS serial communication protocol.	
Special	The converter start is controlled by a special preset signal and switching thresholds, see P[987] SPECIAL START.	

The name of specific (alternative) selection of parameter value

Additional information about the meaning of a specific parameter selection

EXAMPLE:

MENU \ SETTINGS \ COMMANDS \ FREQUENCY SETPOINT \ ... \ SETTINGS \ FUNCTIONS \ LOGICAL BLOCKS \ LB1 (Fast) \

Source of freq. setpoint

Value
Control panel <input checked="" type="checkbox"/>
AIN1 <input type="checkbox"/>
AIN2 <input type="checkbox"/>
AIN3 <input type="checkbox"/>

LB1 Operation

OR <input type="checkbox"/>
AND <input checked="" type="checkbox"/>
XOR <input type="checkbox"/>
RS <input type="checkbox"/>
= <input type="checkbox"/>

One setting option selection of selection type parameter examples

Parameter type: MULTIPLE SELECTION (MASK)

Parameter type with a option to select multiple possible value elections, modes, respectively active bit of parameter.

Basic information about the parameter type - multiple selection

MENU \ SETTINGS \ CONTROL AND REGULATION \ V/f CONTROL \ V/f CURVE \

Name [ID]	Description	Def.
V/f Type [347]	V/f Curve type. Selecting the features of the V/f control method operation.	
<input type="checkbox"/> IR compensation	Turns on the stator resistance loss compensation P[973] Compensation of IR (CIR). Requires correct value of the motor parameters and the stator resistance P[345] Stator resistance.	
<input type="checkbox"/> ST controller	Turns on the starting torque controller P[29] ST Controller (STC) to boost starting torque.	

Names of parameter value elections (modes)

Additional information about the meaning of individual parameter elections (modes)

* When the square is black ■ - the default setting is set

EXAMPLE:

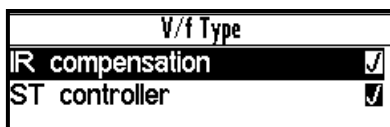

Example: V/f curve operation mode selection

Parameter type: COMMAND

Command to execute a single action or operation on the converter. It is required to confirm the command before execution in the confirmation window.

MENU \ SETTINGS \ CONVERTER PARAMETERS \ Energy consumption \

Name [ID]	Description	Def.
Reset the consumption [897]	This command resets the counters of consumed energy.	

Name and command ID

Function, description and importance of the command

EXAMPLE:

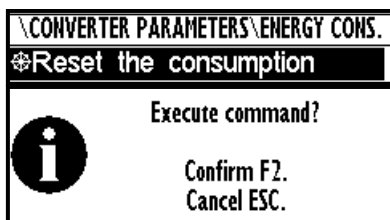

This command resets consumed energy counters

Parameter type: SIGNAL

Parameter for dynamic ties and any parameter connection, that becomes a value source for a given function or for input of this function.

MENU \ SETTINGS \ INPUTS AND OUTPUTS \ ANALOG INPUTS \ AIN1 \ SPECIAL SETTING \

Name [ID]	Description	Def.
AIN1 Signal [251]	Selection of the signal that will be linearly recalculated according to the analog input.	[-]

Signal name

Type of signal selection from the diagnostics

EXAMPLE:

MENU \ SETTINGS \ INPUTS AND OUTPUTS \ ANALOG OUTPUTS \ AO1 \

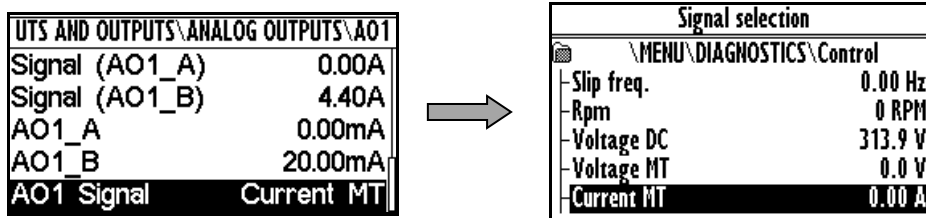

Selection of the signal that will linearly recalculate the analog output AO1

Parameter type: DYNAMIC VALUE (Linked parameter)

Parameter is dynamically set to the value that is inherited from another parameter (usually from the signal type parameter).

MENU \ SETTINGS \ INPUTS AND OUTPUTS \ RELAY OUTPUTS \ Relay 1 \ SPECIAL SETTING \

Name [ID]	Description	Def.
R1 switch on [301]	Conditions for R1 switch on.	Run

Name and ID of the dynamic parameter

Default value of the dynamic value parameter

EXAMPLE:

The condition for RELAY switching „R1 switch on [301]“ – If any parameter (e.g. Cooler temperature [74]) is selected as „R1 Signal [189]“:

MENU \ SETTINGS \ INPUTS AND OUTPUTS \ RELAY OUTPUTS \ Relay 1 \

R1 Source
Ready
Error
Brake
F=zel
Special <input checked="" type="checkbox"/>

Special source of Relay R1 switch setting

MENU \ SETTINGS \ INPUTS AND OUTPUTS \ RELAY OUTPUTS \ Relay 1 \ SPECIAL SETTING R1 \

AY OUTPUTS\Relay 1\SPECIAL SETTING R1	
R1 Signal	Cooler tempe..
R1 switch on	40.0°C
R1 switch off	40.0°C

Relay R1 switches on when heatsink temperature exceeds the set level

The condition for RELAY switching „R1 switch on [301]“ – If status word is selected as „R1 Signal [189]“:

MENU \ SETTINGS \ INPUTS AND OUTPUTS \ RELAY OUTPUTS \ Relay 1 \ SPECIAL SETTING R1 \

AY OUTPUTS\Relay 1\SPECIAL SETTING R1	
R1 Signal	Converter st..
R1 switch on	Error
R1 switch off	-----

Relay R1 switches on at active bite (Failure) of converter status word

R1 switch on	
Error <input checked="" type="checkbox"/>	
SW_Err_Pin <input type="checkbox"/>	
Operation <input type="checkbox"/>	
DC charged <input type="checkbox"/>	
MT excited <input type="checkbox"/>	

Parameter type: PASSWORD

Parameter to enter a password to allow access to the specific levels of converter setting respectively to unlock some of the modes.

The password characters can be {0..9, A..Z}.

MENU \ SETTINGS \ CONVERTER PARAMETERS \

Name [ID]	Description	Def.
Password [548]	Setting the user password for access to the device settings. Password needs to be entered when entering the converter settings.	0 *
0 * ÷ 0 *	Protects the converter settings against reconfiguration by unauthorized persons.	



Basic information about the importance of the parameter



EXAMPLE:



Example of password entry

UNIPANEL – PASSWORD SETTING

Set the required password character:  

Cursor position change:  

After setting the password, press ENTER to confirm.

2.3 Type of parameters defining in the part SAVE / RESTORE

Parameter type: PATH

Parameter of root parameters directory choice defining.

MENU \ SAVE / RESTORE \ Parameters backup \ Parameter transfer \

Name [ID]	Description	Def.
Directory [-]	The choice of which part of the parameters will be restored. If nothing is selected, all will be restored.	INPUTS AND OUTPUTS
0 * ÷ 0 *		

Basic information about the importance of the parameter

The selected path in the tree hierarchy

EXAMPLE:

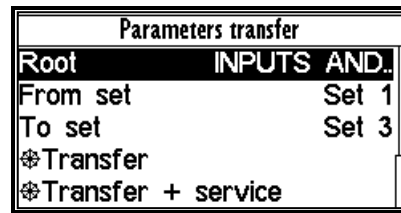
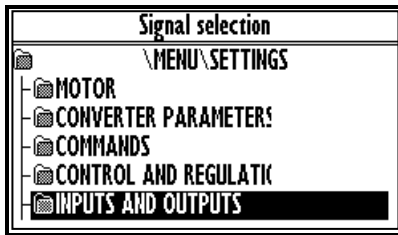

INPUTS AND OUTPUTS root directory selection for the transfer of parameters from set 1 to set 3

3 Range of parameters by product type

3.1 Undervoltage, overvoltage

	Undervoltage [V]	Overvoltage [V]
Unifrem 230 M	220	420
Unifrem 400, 400 M	425	735
Unifrem 500	350	900
Unifrem 690	730	1 250

3.2 Temperatures

	Warning line [°C]	Fault line [°C]
CB temperature [75]	55	70
Cooler temperature [74]	75	90
IGBT chip temp. [96]	75	109

4 DIAGNOSTICS

Group of parameters number [2]
Diagnostic information (quantities and states).

4.1 Command

Group of parameters number [758]
Quantities affecting the converter control, inputs and outputs.

MENU \ DIAGNOSTICS \ COMMAND

Name [ID]	Description	Dim.
Freq. setpoint [162]	Frequency setpoint. Represents the value at the input of ramp block, thus the actual frequency Freq. INV [47] (page 15) is reached after the time ramps reach the setpoint.	Hz
Torque setpoint [923]	Torque setpoint.	Nm
Panel freq. Setpoint [161]	Setpoint value from the panel, entered in the monitor window.	
Discrete setpoint [10]	Discrete setpoint value [60] (page 54).	
Up/down commands [977]	Output from the Up/Down commands [970] (page 56).	%/s
Control word [77]	Control signals of the converter	
<input type="checkbox"/> START	Control command for the motor operation mode (1 - starts the motor).	
<input type="checkbox"/> REVERZ F	Control command for the motor rotation direction (1 - reverse operation mode).	
<input type="checkbox"/> RESET PWM	Control command for the immediate voltage cut-off on the converter output (active - turns off PWM).	
<input type="checkbox"/> FAULT ACK.	Command for fault acknowledgement.	
<input type="checkbox"/> ERR_MASTER	Master fault	
<input type="checkbox"/> COMPENSATION DT	Turn on the dead time compensation mode	
<input type="checkbox"/> SCALAR / VECTOR	0 - scalar control 1 - vector control.	
<input type="checkbox"/> UNF BOARD TYPE	0 - UNF 400, 1 - UNF 230/400 M.	
<input type="checkbox"/> RAMP_F_VSTUP0	Frequency ramp input reset.	
<input type="checkbox"/> RAMP_F_VYSTUP0	Frequency ramp output reset.	
<input type="checkbox"/> RAMP_F_FREEZE	Frequency ramp stop.	
<input type="checkbox"/> QUICK_STOP	Quick emergency drive stop.	
<input type="checkbox"/> REVERZ MOM.	Control command for changing the polarity of the torque setpoint.	
<input type="checkbox"/> Reserve		
ON / OFF time [1577]	Represents the time in AUTO OFF mode to the next automatic start or stop of the inverter.	

4.2 Control

Group of parameters number [759]
Quantities affecting the converter control, values of important control and operating quantities.

MENU \ DIAGNOSTICS \ CONTROL

Name [ID]	Description	Dim.
Freq. INV [47]	Frequency on the converter output. Represents the applied output voltage frequency behind the ramp block with all corrections taken into account (e.g. [348] (page 60)).	Hz
Freq. RT [937]	Rotor frequency evaluated by a mathematical model from electric quantities in open control or from the rotation speed feedback (IRC) in closed control.	Hz
Slip freq. [938]	Slip frequency evaluated by a mathematical model from electric quantities in open control or from the rotation speed feedback (IRC) in closed control. In V/f control, for correction of the stator frequency (slip compensation), [348] (page 60) is used.	Hz

Name [ID]	Description	Dim.
Motor rotation speed [1130]	Rotation speed on the motor shaft. For a correct display, it is necessary to configure the motor parameters according to the motor nameplate and correctly identify Stator resistance [345] (page 44) for the slip model. This value is affected by the actual motor slip and corresponds with the actual rotor speed.	rpm
Voltage [46] DC	Voltage of the DC link. In a steady-state, the voltage gains its value near 1.41 x supply voltage RMS, which corresponds with the nominal voltage of the converter. During the braking, it can rise to the value of BM operating voltage [377] (page 77).	V
Voltage [73] MT	Voltage on the motor terminals is not exactly measured quantity, it is evaluated from PWM modulation index and DC link voltage Voltage DC [46] (page 16).	V
Current [42] MT	RMS value of the motor current.	A
Cos Phi [67]	Motor power factor. Positive values indicate motoric operation and negative values indicate regenerative motor operation.	
Torque [69]	Mechanical torque on the motor shaft. The value of torque is evaluated by the mathematical motor model; its accuracy is influenced mainly by the parameters Rotor resistance [439] (page 45), Mutual inductance [441] (page 45) and Nom. revolutions [356] (page 44). Torque saturation is defined by the parameter Torque setpoint [920] (page 52).	Nm
Mag. Flux [71]	Rotor magnetic flux. Defines the level of motor excitation. Unless the field-weakening is in effect, the value should be close or equal to Magnetic Flux setpoint [452] (page 63).	Wb
Modulation index [768]	PWM duty cycle of the switching power elements.	%

4.2.1 Power and energy

Group of parameters number [486]

Diagnostic group of quantities dealing with the energy indicators (power, consumption, losses).

MENU \ DIAGNOSTICS \ CONTROL \ POWER AND ENERGY

Name [ID]	Description	Dim.
Input power [70]	Active motor input power of the motor without considering any losses.	W
Power [66]	Active motor power, evaluated from voltage, current and power factor of the motor.	W
kWh Consumption [429]	Number of consumed kWh. This value can be reset by the command Reset the consumption [897] (page 48).	kWh
MWh Consumption [430]	Number of consumed MWh. This value can be reset by the command Reset the consumption [897] (page 48).	MWh
Power restriction [1092]	Coefficient of power restriction from external effects. At maximal allowed power or current the value 1 is acquired and when power restriction is in effect, this value is decreased to 0. Individual conditions of the power restriction can be selected in Power restriction (PR) [766] (page 78).	
Power restriction - F [983]		

4.2.2 Additional quantities

Group of parameters number [534]

Additional and derived quantities for special use.

MENU \ DIAGNOSTICS \ CONTROL \ ADDITIONAL QUANTITIES

Name [ID]	Description	Dim.
Freq. INV ramp [487]	Frequency on the ramp block output. Represents the speed controller (SC) reference in the vector control mode.	Hz
Freq. INV abs. [472]	Frequency on the converter output in an absolute value.	Hz
Rpm behind the transmission [907]	Rotation speed behind the transmission. To display it correctly, it is necessary to correctly enter the parameter Gear ratio [888] (page 46).	rpm
Freq. mech. gear	Mechanical frequency, at gear output.	Hz

Name [ID]	Description	Dim.
[1541]		
Speed m/s [68]	Speed behind the gear. To calculate the value correctly, it needs the correct setting of Gear ratio [888] (page 46) and Wheel circumference [889] (page 46).	m/s
Acceleration m/s ² [1698]	Acceleration behind the gear. To calculate the value correctly, it needs the correct setting of Gear ratio [888] (page 46) and Wheel circumference [889] (page 46).	m/s ²
Acceleration m/s ² [684]	Deceleration is calculated from Acceleration m/s ² [1698] (page 17), only when decelerating.	m/s ²
Max. current [494]	Motor current RMS value limitation on the converter output. During an excessive converter load, maximal current can drop from the value Max. mot. current [5] (page 75) to the value Permanent current [24] (page 47).	A
Current MT unfilt. [49]	RMS value of the non filtered motor current (load).	A
Curr. phase U [1221]	U-phase current RMS value at the output of frequency converter.	A
Curr. phase V [1222]	V-phase current RMS value at the output of frequency converter.	A
Curr. phase W [1223]	W-phase current RMS value at the output of frequency converter.	A
Sum of I-AC [831]	Filtrated absolute sum of AC currents for evaluation of leak or current measurement fault.	A
VL1_rms [1519]	RMS value of L1 phase voltage. This voltage can represent supply or generated grid voltage, according to connection.	V
VL2_rms [1520]	RMS value of L2 phase voltage. This voltage can represent supply or generated grid voltage, according to connection.	V
VL3_rms [1521]	RMS value of L3 phase voltage. This voltage can represent supply or generated grid voltage, according to connection.	V
Vph-ph_rms [1697]	RMS value of average phase-to-phase voltage. This voltage can represent supply or generated grid voltage, according to connection.	V

4.2.3 Positioning

Group of parameters number [1146]

Quantities for position control diagnostics. The position unit is given by the parameter Position unit [1540] (page 67).

MENU \ DIAGNOSTICS \ CONTROL \ POSITIONING

Name [ID]	Description	Dim.
Pos. setpoint [1149]		rev
Pos. error [1148]	Difference between position setpoint Pos. setpoint [1149] (page 17) and actual position Position [1636] (page 17).	rev
Position [1636]	Position evaluated from Position source [1141] (page 58) signal.	rev
Positioning status [1648]		
<input type="checkbox"/> Position reached		
<input type="checkbox"/> Synchronizing		
<input type="checkbox"/> Synchronizované		
<input type="checkbox"/> Min cam position	The minimum position of the cam is reached and the shape of the cam will be deformed.	
<input type="checkbox"/> Max cam position	The maximum position of the cam is reached and the shape of the cam will be deformed.	
Rev. shift [1646]	Current value of Rev. shift [1649] (page 67), when changing at the rate given by Shift change rate [1143] (page 67).	rev
Position slave [1147]	Slave position (this device) for master-slave control (electronic shaft) e.g. IRC1-IRC2 or ARC-ARCmaster.	rev
Position master [1537]	Master position for master-slave control (electronic shaft) e.g. IRC1-IRC2 or ARC-ARCmaster.	rev

4.3 Inputs and outputs

Group of parameters number [859]

Diagnostics of the converter inputs and outputs.

4.3.1 BIN

Group of parameters number [1212]

MENU \ DIAGNOSTICS \ INPUTS AND OUTPUTS \ BIN

Name [ID]	Description	Dim.
Binary inputs [184]	State of the binary inputs. Filled rectangle represents the BINx physical switch-on.	
<input type="checkbox"/> BIN1	State of 1st binary input (Terminal 1).	
<input type="checkbox"/> BIN2	State of 2nd binary input (Terminal 2).	
<input type="checkbox"/> BIN3	State of 3rd binary input (Terminal 3).	
<input type="checkbox"/> BIN4	State of 4th binary input (Terminal 4).	
<input type="checkbox"/> BIN5	State of 5th binary input (Terminal 5).	
<input type="checkbox"/> BIN6	State of 6th binary input (Terminal 6).	

4.3.2 AIN

Group of parameters number [82]

Diagnostic group of quantities for the analog inputs of the converter AIN1 to AIN4.

Parameters of the analog inputs can be configured in the parameter group [144] (page 80).

MENU \ DIAGNOSTICS \ INPUTS AND OUTPUTS \ AIN

Name [ID]	Description	Dim.
AIN1 [256]	Value of the signal brought to the analog input terminals X1:11 and - X1:12 in physical units. Using the parameter AIN1 Signal [251] (page 81) select the quantity that will be changed according to the analog input level change. Parameters of the analog input can be configured in the parameter group [147] (page 81).	V
AIN1 Rel. [41]	Relative value of the signal connected to the analog input terminals + X1:11 and - X1:12. Parameters of the analog input can be configured in the parameter group [147] (page 81).	%
AIN2 [280]	Value of the signal brought to the analog input terminals X1:13 and - X1:14 in physical units. Using the parameter AIN2 Signal [259] (page 82) select the quantity that will be changed according to the analog input level change. Parameters of the analog input can be configured in the parameter group [149] (page 81).	V
AIN2 Rel. [43]	Relative value of the signal connected to the analog input terminals + X1:13 and - X1:14. Parameters of the analog input can be configured in the parameter group [149] (page 81).	%
AIN3 [281]	Value of the signal brought to the analog input terminals X1:15 and - X1:16 in physical units. Using the parameter AIN3 Signal [269] (page 83) select the quantity that will be changed according to the analog input level change. Not available for the UNIFREM 400 M V converters. Parameters of the analog input can be configured in the parameter group [148] (page 82).	V
AIN3 Rel. [44]	Relative value of the signal connected to the analog input terminals + X1:15 and - X1:16. Not available for the UNIFREM 400 M converters. Parameters of the analog input can be configured in the parameter group [148] (page 82).	%
AIN4 [282]	Value of the signal brought to the analog input terminals X1:17 and - X1:18 in physical units. Using the parameter AIN4 Signal [275] (page 84) select the quantity that will be changed according to the analog input level change. Not available for the UNIFREM 400 M V converters. Parameters of the analog input can be configured in the parameter group [152] (page 83).	V
AIN4 Rel. [45]	Relative value of the signal connected to the analog input terminals + X1:17 and - X1:18. Not available for the UNIFREM 400 M converters. Parameters of the analog input can be configured in the parameter group [152] (page 83).	%
AIN_RM [1643]	The value of the signal applied to the AIN-RM analog input terminals, which is used to accurately measure motor temperature at SERVOFREM inverters.	V

4.3.3 RELAYS

Group of parameters number [217]

MENU \ DIAGNOSTICS \ INPUTS AND OUTPUTS \ RELAYS

Name [ID]	Description	Dim.
Relay [185]	Condition of the output relays. Filled rectangle represents the RELEx physical switch-on.	
<input type="checkbox"/> RELAY1	Condition of the 1st output relay.	
<input type="checkbox"/> RELAY2	Condition of the 2nd output relay.	
<input type="checkbox"/> RELAY3	Condition of the 3rd output relay. Not available for the converters UNIFREM 400 M.	

4.3.4 AOUT

Group of parameters number [700]

Diagnostic group of quantities for the analog inputs of the converter AOUT1 to AOUT3.

MENU \ DIAGNOSTICS \ INPUTS AND OUTPUTS \ AOUT

Name [ID]	Description	Dim.
AO1 [701]	Recalculated value of the signal on the analog input terminals X1:19 and X1:20 (X1:15 and X1:16 for UNIFREM 400 M). Using the parameter AO1 Signal [359] (page 87), select the quantity according to which the analog output level is changed. Parameters of the analog input can be configured in the parameter group [370] (page 87).	A
AO2 [702]	Recalculated value of the signal on the analog input terminals X1:21 and X1:22 (X1:17 and X1:16 for UNIFREM 400 M). Using the parameter AO2 Signal [364] (page 88), select the quantity according to which the analog output level is changed. Parameters of the analog input can be configured in the parameter group [371] (page 87).	A
AO3 [703]	Recalculated signal value on the terminals of the analog output X1:23 and X1:24. Using the parameter AO3 Signal [365] (page 88), select the quantity according to which the analog output level is changed. Not available for the UNIFREM 400 M converters. Parameters of the analog input can be configured in the parameter group [372] (page 88).	A

4.3.5 IRC

Group of parameters number [1001]

Diagnostic quantities for the IRC speed sensors.

MENU \ DIAGNOSTICS \ INPUTS AND OUTPUTS \ IRC

Name [ID]	Description	Dim.
Freq. IRC1 [434]	Rotor frequency defined by the rotation speed sensor from the IRC1. It is the mechanical frequency, its value can be several times lower than electrical frequency. The ratio between the frequencies is defined by the number of pole couples (Nr of motor poles [1049] (page 46)). For correct evaluation of the speed from the IRC sensor, it is necessary to correctly configure IRC1 pulses [436] (page 89).	Hz
Freq. IRC2 [803]	Rotor frequency defined by the IRC2 encoder. It is the mechanical frequency, its value can be several times lower than electrical frequency. The ratio between the frequencies is defined by the number of pole pairs Nr of motor poles [1049] (page 46).	Hz
Freq. IRC1-IRC2 gear [1086]	Frequency difference between IRC1 and IRC2 at gear output. This quantity is filtered by the first order filter configured by the parameter Filter dIRC1,2 [1083] (page 113).	Hz
Chyba IRC [1623]	Status word of IRC fault.	
<input type="checkbox"/> ERR output EM <input type="checkbox"/> Incorrect reverses of IRC1 <input type="checkbox"/> Incorrect reverses of IRC2		
IRC1 pos. 32b high [1616]	High 32 bits of IRC1 position at gear output.	
IRC1 pos. 32b low [1539]	Low 32 bits of IRC1 position at gear output.	
IRC2 pos. 32b high [1287]	High 32 bits of IRC2 position at gear output.	
IRC2 pos. 32b low	Low 32 bits of IRC2 position at gear output.	

Name [ID]	Description	Dim.
[1535]		

4.3.6 ARC

Group of parameters number [914]

Diagnostic quantities for the ARC speed sensors.

MENU \ DIAGNOSTICS \ INPUTS AND OUTPUTS \ ARC

Name [ID]	Description	Dim.
ARC angle [290]	Angle within one revolution evaluated from absolute position sensor in degrees.	°
Freq. ARC [291]	ARC rotor frequency evaluated by the RM-SERVO extension module.	Hz
ARCmaster angle [1667]	Master position within one revolution, in degrees. Set in 1ms interrupt.	°
Freq. ARCmaster [1617]	ARCmaster device rotor frequency evaluated by the RM-SERVO extension module.	Hz
ARC pos. 32b high [1543]	High 32 bits of ARC position at gear output.	
ARC pos. 32b low [1607]	Low 32 bits of ARC position at gear output.	
ARCmaster pos. 32b high [1288]	High 32 bits of ARCmaster position at gear output.	
ARCmaster pos. 32b low [1621]	Low 32 bits of ARCmaster position at gear output.	
RM-SERVO error [1608]	Fault of the absolute encoder or RM-SERVO extension module.	
<input type="checkbox"/> CRC	Too many CRC errors.	
<input type="checkbox"/> Inverter	Module is not receiving valid data from the converter.	
<input type="checkbox"/> Eeprom	Memory error of the module.	
<input type="checkbox"/> Modbus	Modbus master is not communicating with the module.	
<input type="checkbox"/> CAN	CAN timeout.	
<input type="checkbox"/> EnDat timeout	EnDat encoder is not communicating with the module.	
<input type="checkbox"/> EnDat	EnDat encoder is reporting a fault.	
<input type="checkbox"/> Reserve		
<input type="checkbox"/> Reserve		
<input type="checkbox"/> Inverter 2		
<input type="checkbox"/> Eeprom 2		
<input type="checkbox"/> Modbus 2		
<input type="checkbox"/> CAN 2		
<input type="checkbox"/> EnDat timeout 2		
<input type="checkbox"/> EnDat 2		
Servo CRC errors [1542]	CRC error counter of the communication between the converter and RM-SERVO module.	
CRC error rate [933]	Communication error rate with RM-SERVO. Zero value means reliable transmission.	%
Status RM_ARC [292]	Status of RM_ARC extension module.	
Ok	RM ARC is communicating ok, or there is no module selected.	
LOT	Loss of Position Tracking error.	
DOS	Degradation of signal (DOS) is detected when any resolver input signal is corrupted.	
LOS	Loss of signal (LOS) is detected when any resolver input falls below the fixed threshold. Most likely the resolver is disconnected.	
Parity	Parity check of communication between ARC and the converter failed.	
RDVEL	Incorrect value read from ARC module.	

4.4 Functions

Group of parameters number [760]

Quantities regarding the remaining optional functions of the converter.

4.4.1 PLC function

Group of parameters number [1278]

Numerical and logical blocks output.

MENU \ DIAGNOSTICS \ FUNCTIONS \ PLC FUNCTION

Name [ID]	Description	Dim.
Logical blocks [8]	Logical operation outputs, first two LB are fast (they respond in 1ms), others are slower (10ms).	
<input type="checkbox"/> LB1	LB1 status	
<input type="checkbox"/> LB2	LB2 status	
<input type="checkbox"/> LB3	LB3 status	
<input type="checkbox"/> LB4	LB4 status	
<input type="checkbox"/> LB5	LB5 status	
<input type="checkbox"/> LB6	LB6 status	
<input type="checkbox"/> LB7	LB7 status	
<input type="checkbox"/> LB8	LB8 status	

Numerical blocks

Group of parameters number [312]

Output of numerical blocks.

MENU \ DIAGNOSTICS \ FUNCTIONS \ PLC FUNCTION \ NUMERICAL BLOCKS

Name [ID]	Description	Dim.
NB1 [1274]	Result of operation of the first numerical block.	
NB2 [1275]	Result of operation of the second numerical block.	
NB3 [1276]	Result of operation of the third numerical block.	
NB4 [1277]	Result of operation of the fourth numerical block.	
NB5 [1692]	Result of operation of the fifth numerical block.	
NB6 [1693]	Result of operation of the sixth numerical block.	

4.4.2 Limit switches

Group of parameters number [890]

States and tracks of the limit switches.

MENU \ DIAGNOSTICS \ FUNCTIONS \ LIMIT SWITCHES

Name [ID]	Description	Dim.
LS [919]	Limit switch state.	
<input type="checkbox"/> LS1	LS1 inactive/active.	
<input type="checkbox"/> LS2	LS2 inactive/active.	
<input type="checkbox"/> LS3	LS3 inactive/active.	
<input type="checkbox"/> LS4	LS4 inactive/active.	
<input type="checkbox"/> Slows down F>0	Slow down in effect for positive frequency.	
<input type="checkbox"/> Slows down F<0	Slow down in effect for negative frequency.	
LS1 Track [891]	Number of meters run during the activated limit switch function.	m
LS1 Track in km [929]	Number of kilometers run during the activated limit switch function.	km
LS2 Track [892]	Number of meters run during the activated limit switch function.	m
LS2 Track in km [930]	Number of kilometers run during the activated limit switch function.	km
LS3 Track [893]	Number of meters run during the activated limit switch function.	m
LS3 Track in km [931]	Number of kilometers run during the activated limit switch function.	km
LS4 Track [894]	Number of meters run during the activated limit switch function.	m
LS4 Track in km [932]	Number of kilometers run during the activated limit switch function.	km

4.4.3 Process controller

Group of parameters number [18]

Diagnostic group of the process controller quantities.

MENU \ DIAGNOSTICS \ FUNCTIONS \ PROCESS CONTROLLER

Name [ID]	Description	Dim.
Setpoint PC [21]	Setpoint value of the process controller.	%
Feedback PC [409]	Feedback value of the process controller. If the process controller is turned on and works correctly, the value is near the value Setpoint value [407] (page 104).	%
Error PC [410]	Regulation error of the process controller. In steady-state, it should be close to 0.	%
Output PC [64]	Action value (output) of the process controller.	
State PC [820]	Actual state of the process controller.	
<input type="checkbox"/> Lower saturation	Process controller operates at lower saturation.	
<input type="checkbox"/> Upper saturation	Process controller operates at upper saturation.	
<input type="checkbox"/> Error in the dead-zone	Process controller error in the dead-zone.	
<input type="checkbox"/> Positive error	Process controller error is positive.	
<input type="checkbox"/> SP achieved	If error is lower than hysteresis.	
<input type="checkbox"/> Parked	Process controller is parked.	
<input type="checkbox"/> PC Reset	Active PC RESET - integration term and the output are equal to the value PC Reset value [1131] (page 106).	

4.4.4 Optimization

Group of parameters number [707]

Setting the parameters for the optimization block that is used to search for the extremum of any signal using the change of a selected entering setpoint signal.

Optimization searches for an output value, at which it reaches the criteria of the selected signal. During the optimization, if the measurement conditions and the operation condition are met, new output samples are counted in defined intervals. The found global extremum is stored to the memory. In case the optimization output should apply, it is necessary to select its output as the source of the setpoint value.

MENU \ DIAGNOSTICS \ FUNCTIONS \ OPTIMIZATION

Name [ID]	Description	Dim.
OPT Output [423]	Output value of the optimization block. You can watch the status and quality of the optimization process here. 100% represents the min.-max. range from the setpoint channel, which is connected to the optimization block (see [65] (page 106)).	
Optimization step [742]	Optimization step represents the difference between two consecutive optimization algorithm samples. (see [65] (page 106)).	
OPT Starting point [708]	Defines the starting point of the optimization at the optimization start, when scanning is turned off.	
OPT State [709]	Shows the present state the optimization block.	
<input type="checkbox"/> Reset	Optimization is in initial or blocked state.	
<input type="checkbox"/> Measuring	Measuring of the optimized quantity is running.	
<input type="checkbox"/> Scan	Scanning of the whole optimization output range is running.	
<input type="checkbox"/> Tuning	State of fine tuning and searching for the optimization point.	

4.4.5 Lifting functions

Group of parameters number [853]

Diagnostic group of quantities for the drive OPS switch, load calculation and dynamic lift.

MENU \ DIAGNOSTICS \ FUNCTIONS \ LIFTING FUNCTIONS

Name [ID]	Description	Dim.
Load [854]	Drive load rate evaluated from the signal Load. signal [843] (page 109) related to 100% Load [844] (page 109).	%
Short	Number of forbidden short commands. After exceeding the short commands count,	

Name [ID]	Description	Dim.
commands count [855]	the OPS switch will switch regardless of the drive load. Short commands evaluation can be turned off by the parameter OPS mode. [842] (page 109).	
OPS status [856]	Indicates the status of the OPS switch block.	
<input type="checkbox"/> Reset	RESET signal of the OPS is active.	
<input type="checkbox"/> Detection	Autodetection of the overload limits is running.	
<input type="checkbox"/> Overload	Overload occurred. Operation in the positive direction (up) is blocked.	
<input type="checkbox"/> Tipping	Too many forbidden tipping control commands.	
<input type="checkbox"/> Settling	Drive operates in static mode.	
<input type="checkbox"/> Dynamics	Drive operates in dynamic mode.	

4.4.6 Pantograph/isol. monitor

Group of parameters number [122]

Diagnostics of the Pantograph outage function and isolation monitor.

MENU \ DIAGNOSTICS \ FUNCTIONS \ PANTOGRAPH/ISOL. MONITOR

Name [ID]	Description	Dim.
Pant/isol status [112]	Status of the Pantograph outage function and isolation measurement.	
<input type="checkbox"/> Pantograph fault	Fault " E41-Pantograph outage (page 33)" occurred.	
<input type="checkbox"/> Pantograph warning	Warning " W39-Pantograph outage (page 30)" occurred.	
<input type="checkbox"/> Turning off CHARGE	The charging contactor switched off during a pantograph outage fault or warning.	
<input type="checkbox"/> Motor torque = 0	During the pantograph outage, the motor restricted the motor torque to zero.	
<input type="checkbox"/> Enabled	Pantograph functions are enabled.	
<input type="checkbox"/> Block warnings	Blocking of warning is enabled.	
<input type="checkbox"/> Isolation fault warning	Warning " W69-Isolation fault (page 31)" occurred.	
Pant/isol V [113]	Voltage of the pantograph / isolation measurement.	V
V pant/isol-DC voltage [1629]	Voltage of the U1-L2 input, difference against Voltage DC [46] (page 16).	V

4.4.7 Ext. thermal protection

Group of parameters number [868]

Diagnostic group of quantities of the external thermal protection (ETP).

MENU \ DIAGNOSTICS \ FUNCTIONS \ EXT. THERMAL PROTECTION

Name [ID]	Description	Dim.
ETP Temperature [869]	Temperature of the ETP sensor. After exceeding the temperature defined in the parameter ETP Warning [865] (page 112), the converter generates a warning. After exceeding the temperature defined in the parameter ETP Fault [866] (page 112), the converter generates the fault " E38-ETP temperature (page 33)".	°C
ETP Current [870]	Measuring current of the external thermal protection. By rule, it is selected as the signal source of an analog input, AOUT1 to AOUT3.	mA
ETP Voltage [867]	Value of measured voltage drop on the ETP sensor.	V
Sensor resistance [871]	Resistance value of the ETP sensor. By multiple sensors connected to a series, it represents the average resistance value on one of them.	Ω

4.4.8 Differential

Group of parameters number [1243]

Quantities for torque differential diagnostics.

MENU \ DIAGNOSTICS \ FUNCTIONS \ DIFFERENTIAL

Name [ID]	Description	Dim.
Value difference [1244]	Difference between the values of Sig.1 Value [1249] (page 113) and Sig.2 Value [1240] (page 113).	Nm
Freq. setpoint correction [1245]	Frequency setpoint correction caused by differential operation.	Hz

4.5 Converter state

Group of parameters number [761]

Quantities regarding the overall state of the converter and its components.

MENU \ DIAGNOSTICS \ CONVERTER STATE

Name [ID]	Description	Dim.
Voltage 24V [72]	DC control voltage of 24V. Option for the detection of the supply load caused by the control inputs and outputs. Converter generates the fault " E16-Supply overload (page 32)" when the voltage drops.	V
Battery voltage [773]	Voltage of the battery that backs up the history logs in the converter.	V
Converter operational hours [496]	Converter operational hours. Converter operation time when switched on (RUN). This value can be reset by authorized technicians only.	h
MT operational hours [497]	Motor operational hours. Converter operation time. This value can be reset by the command Reset the motor operation hours MT [1075] (page 44).	h
Converter state [76]	Status word of the converter.	
<input type="checkbox"/> Fault	Converter is in fault.	
<input type="checkbox"/> SW_Err_Pin	System, internal converter status.	
<input type="checkbox"/> Run	Converter generates voltage on the outputs.	
<input type="checkbox"/> DC charged	DC link is charged.	
<input type="checkbox"/> MT excited	Motor is excited.	
<input type="checkbox"/> Accel./Decel. F	Inactive - motor accelerates, active - motor decelerates.	
<input type="checkbox"/> Fsp > 0	Active - forward (+), inactive - backward (-). It is the polarity of the setpoint frequency.	
<input type="checkbox"/> F = Fsp	When active, the setpoint frequency is achieved.	
<input type="checkbox"/> Warning	Warning or functional message occurred in the converter.	
<input type="checkbox"/> Active	Always active. It can be used as logical 1.	
<input type="checkbox"/> Deexciting MT	Motor is still excited, the start is blocked.	
<input type="checkbox"/> Ready	Converter is ready for the start command. (READY).	
<input type="checkbox"/> Mechanical brake	Mechanical brake relay control. Brake is released when active.	
<input type="checkbox"/> Motor/generator	Active - regenerative operation mode, inactive - motoric operation mode.	
<input type="checkbox"/> Frot > 0	Rotor frequency polarity. If IRC is not available, then it represents the sign of the frequency evaluated by the mathematical model.	
Status word negated [547]	Negated status word.	
Look choises of parameter's Converter state [76] (page 24)		
Warning [250]	State of individual warnings.	
Warning2 [424]	State of individual warnings.	
Warning3 [1627]	State of individual warnings.	
Fault [781]	State of individual faults.	
Fault2 [780]	State of individual faults.	
SERVO-errors [1644]	Special errors for SERVO-inverters	
<input type="checkbox"/> ERTU	short circuit on phase U	
<input type="checkbox"/> OCU	overcurrent on phase U	
<input type="checkbox"/> ERTV	short circuit on phase V	
<input type="checkbox"/> OCV	overcurrent on phase V	
<input type="checkbox"/> ERTW	short circuit on phase W	
<input type="checkbox"/> OCW	overcurrent on phase W	
<input type="checkbox"/> ERB	short circuit on brake module BM	
<input type="checkbox"/> EXRM1	external HW error	

4.6 Thermal protections

Group of parameters number [485]

Diagnostic group of quantities regarding the thermal protections and overloads.

MENU \ DIAGNOSTICS \ THERMAL PROTECTIONS

Name [ID]	Description	Dim.
Cooler temperature [74]	Temperature of the power elements cooler. Converter generates a warning " W6-Cooler temperature (page 28)" after exceeding the temperature set by Cooler temperature warning [767] (page 118). Converter generates the fault " E1-Cooler temperature (page 32)" after exceeding the temperature set by service parameter "Cooler temp. fault". If the temperature falls below minimal limit of sensor, this value is inaccessible. If the cooler temperature drops under the minimal measuring range, the displayed value is inaccessible.	°C
IGBT chip temp. [673]	Chip temperature of power elements.	°C
CB temperature [75]	Control board (CB) temperature. When the temperature exceeds the parameter CB temperature warning [204] (page 118) converter generates a warning " W7-CB temperature (page 28)". After exceeding the critical temperature set by service parameter "CB temper. fault" converter generates the fault " E22-CB temperature (page 32)". If the temperature falls below minimal limit of sensor, this value is inaccessible. If the temperature drops under the minimal limit of the measurement channel, the displayed value is inaccessible.	°C
Thermal integral [31] INV	Warming rate of the converter. The fault " E8-Converter overload (page 32)" is generated after exceeding 100% by this value.	%
Thermal integral [1219] INV	Time remaining until the end of fault " E8-Converter overload (page 32)".	s
Thermal integral MT [33]	Motor warming rate, the " E29-Motor overload (page 33)" fault occurs after exceeding 100%.	%
Thermal integral [1220] MT	Time remaining until the end of fault " E29-Motor overload (page 33)".	s
Max. Tchip load IGBT [295]	Maximal chip temperature model for fault evaluation " E49-IGBT Module overheating (page 34)". The fault occurs when the 125°C value is exceeded.	°C
IGBT load [296]	IGBT module load rate. Over 90% of this value the warning " W14-IGBT Overheating (page 28)" occurs and when 100% are exceeded, the fault " E49-IGBT Module overheating (page 34)" is generated.	%

4.7 Communication

Group of parameters number [219]

Information regarding serial communications MODBUS, PROFIBUS, RS485, CAN.

4.7.1 MODBUS

Group of parameters number [661]

MODBUS protocol diagnostics on the RS 485 and USB ports.

MENU \ DIAGNOSTICS \ COMMUNICATION \ MODBUS

Name [ID]	Description	Dim.
Modbus setpoint value [934]	Setpoint value from the Modbus protocol.	%
SW_MODBUS [935]	State word sent over the Modbus communication. For a more detailed description, see the documentation for MODBUS communication protocol. Look choises of parameter's SW_PB [804] (page 26)	
CW_MODBUS [936]	Command Word sent by the Modbus master. For a more detailed description, see the documentation for MODBUS communication protocol. Look choises of parameter's CW_PB [805] (page 26)	
Last Addr. [662]	Last received address of the device.	
Last Func. [663]	Last received function (may also be another device).	

Name [ID]	Description	Dim.
Last register [741]	Last received register (only for this device, it is shown first if there is access to multiple registers).	
Last result [664]	Result of the last received function determined for this device.	
Last length [665]	Size (in bytes) of the last received frame over MODBUS.	
Last CRC [666]	Last received CRC (it can also be a frame for another device)	
Message count [740]	Count of all received messages, including error messages.	
CRC error count [668]	Count of all received CRC error count messages.	
Exception count [800]	Number of messages, which are responded by the error messages.	
Slave count [801]	Count of received messages with a valid device address.	
No response [802]	Count of received messages with a valid device address, when the device did not respond.	

4.7.2 PROFIBUS

Group of parameters number [817]
PROFIBUS diagnostics.

MENU \ DIAGNOSTICS \ COMMUNICATION \ PROFIBUS

Name [ID]	Description	Dim.
Profibus setpoint value [809]	Setpoint value received over the Profibus protocol.	%
SW_PB [804]	Status word sent over the Profibus communication. For a more detailed description, see the documentation for Profibus Extension Module.	
<input type="checkbox"/> Ready To Switch On	Convert Reset, Quick stop are inactive, no faults or initialization are present.	
<input type="checkbox"/> Ready To Operate	Converter is ready for the start command.	
<input type="checkbox"/> Operation Enabled	Converter generates voltage on the outputs.	
<input type="checkbox"/> Fault Present	Converter is in fault.	
<input type="checkbox"/> No OFF 2	Inactive - Reset is active, outputs of the converter are blocked, active - Reset is not active.	
<input type="checkbox"/> No OFF 3	Inactive - Quick stop is active, active - Quick stop is inactive.	
<input type="checkbox"/> Switching On Inhibited	Reset or Quick stop are active, or an initialization or fault are present.	
<input type="checkbox"/> Warning Present	Warning or functional message occurred in the converter.	
<input type="checkbox"/> Speed Error within tolerance	When active, the setpoint frequency is achieved.	
<input type="checkbox"/> Control Requested	Inactive - converter does not accept Control Word over communication. Active - converter is controlled by Control Word received over communication.	
<input type="checkbox"/> F or n Reached	When active, the setpoint frequency is achieved.	
<input type="checkbox"/> Run	Converter generates voltage on the outputs.	
<input type="checkbox"/> Set b0	Bit 0 of active set binary combination.	
<input type="checkbox"/> Set b1	Bit 1 of active set binary combination.	
<input type="checkbox"/> LB3	Status of logical block 3.	
<input type="checkbox"/> LB4	Status of logical block 4.	
CW_PB [805]	Command word sent by the Profibus master. For a more detailed description, see the documentation for Profibus Extension Module.	
<input type="checkbox"/> ON	Converter is ready to accept the START command.	
<input type="checkbox"/> No OFF 2	Inactive - Reset is active, Active - normal converter operation.	
<input type="checkbox"/> No OFF 3	Inactive - Quick stop is active, active - normal converter operation.	
<input type="checkbox"/> Enable Operation	Start. Converter starts generating voltage on its output terminals.	
<input type="checkbox"/> Enable Ramp Generator	Inactive - ramp input is set to zero, active - normal operation of the ramp input block.	
<input type="checkbox"/> Unfreeze Ramp	Inactive - ramp output is frozen, active - ramp is operating normally.	
<input type="checkbox"/> Enable Setpoint	Inactive - ramp input is set to zero, active - normal operation of the ramp input block.	
<input type="checkbox"/> Fault Acknowledge	Fault acknowledgement (only transition inactive-active). Fault acknowledgement has	

Name [ID]	Description	Dim.
	to be allowed in Fault acknowledgement source [165] (page 116).	
<input type="checkbox"/> Bit 8	Unused	
<input type="checkbox"/> Bit 9	Unused	
<input type="checkbox"/> Control by PLC	Inactive - converter does not accept Control Word. Active - converter is controlled by Control Word.	
<input type="checkbox"/> Bit 11	Unused	
<input type="checkbox"/> Bit 12	Unused	
<input type="checkbox"/> Bit 13	Unused	
<input type="checkbox"/> Bit 14	Unused	
<input type="checkbox"/> Bit 15	Unused	
PB-MASTER Error [819]	Number of communication errors between the Profibus module and the Profibus master.	
PB-INV Error [818]	Number of communication errors between the converter and the Profibus module.	

4.7.3 RS LINKS

Group of parameters number [228]
Serial lines diagnostics.

MENU \ DIAGNOSTICS \ COMMUNICATION \ RS LINKS

Name [ID]	Description	Dim.
FRAME_ERR_USB [232]	USB wrongly received data count. (wrong parity, wrong stop bit,...)	
FRAME_ERR_RS485 [229]	RS 485 wrongly received data count. (wrong parity, wrong stop bit,...)	
FRAME_ERR_EXT_MODUL [233]	RS external module wrongly received data count. (wrong parity, wrong stop bit,...)	

4.8 SW and HW version

Group of parameters number [762]
Information about the converter and its components (Mostly static information).

MENU \ DIAGNOSTICS \ SW AND HW VERSION

Name [ID]	Description	Dim.
UNIFREM SW version [379]	UNIFREM converter SW version.	
Prod. number [734]	Production number of device.	
Uniq. number 1 [35]	First part of the converter unique number.	
Uniq. number 2 [36]	Second part of the converter unique number.	
Parameter date [380]	Parameter generating date.	
Parameter time [381]	Parameter generating time.	

4.9 Date and Time

Group of parameters number [1213]

MENU \ DIAGNOSTICS \ DATE AND TIME

Name [ID]	Description	Dim.
Date [210]	Current date.	
Time [209]	Current time.	
Day [1046]	Current day.	
<input type="checkbox"/> Monday <input type="checkbox"/> Tuesday <input type="checkbox"/> Wednesday <input type="checkbox"/> Thursday <input type="checkbox"/> Friday <input type="checkbox"/> Saturday <input type="checkbox"/> Sunday		
Trial period [1006]	Number of days until the trial period of the converter expires.	d

5 WARNINGS

A sample display	Description
F1-PWM Reset	Converter outputs are blocked. RESET sources can be a binary input or any signal (see Reset source [704] (page 49)).
W2-DC charging	If this warning is present longer than 30 seconds after the converter start, the charging relay probably did not switch, which can be caused by incorrect supply parameters, or damaged charging circuit of the converter. For the duration of the warning, the value of Voltage DC [46] (page 16) is displayed in FAULTS window.
W3-System problem	Software problem occurred. Please, contact the service.
W4-24V Overload	24V power supply voltage dropped under 22V. 24V supply is probably overloaded. For the duration of the warning, the value of Voltage 24V [72] (page 24) is displayed in FAULTS window.
F5-Power restriction	Power restriction after reaching critical temperature or an overload status. Power restriction function is configured in the parameter Power restriction (PR) [766] (page 78). For the duration of the warning, the value of Power restriction [1092] (page 16) is displayed in FAULTS window.
W6-Cooler temperature	High cooler temperature. Cooler temperature Cooler temperature [74] (page 25) exceeded the value defined by the parameter Cooler temperature warning [767] (page 118). If the automatic power restriction Power restriction (PR) [766] (page 78) function is turned on, the converter can restrict power. Life cycle of the device decreases when the device is overheated excessively and very often. For the duration of the warning, the value of Cooler temperature [74] (page 25) is displayed in FAULTS window.
W7-CB temperature	High temperature of control board. CB temperature CB temperature [75] (page 25) exceeded value of parameter CB temperature warning [204] (page 118). Life cycle of the device decreases when the device is overheated excessively and very often. For the duration of the warning, the value of CB temperature [75] (page 25) is displayed in FAULTS window.
W8-DC Undervoltage	Low voltage of the DC link. The value Voltage DC [46] (page 16) dropped under the fault limit DC Undervoltage - control and evaluation of other faults is blocked. For the duration of the warning, the value of Voltage DC [46] (page 16) is displayed in FAULTS window.
W9- PWM saturation	Converter reached maximum voltage on the output. At actual voltage value of the DC link, duty cycle of the PWM modulation is at maximum and the current controllers are saturated. Quality of the regulation decreases. For the duration of the warning, the value of Modulation index [768] (page 16) is displayed in FAULTS window.
W10-INV Overload	Converter is overloaded - converter integral Thermal integral INV [31] (page 25) exceeded the 90% value and the fault " E8-Converter overload (page 32)" can occur shortly, after which the converter is blocked for a longer time! If the automatic power restriction Power restriction (PR) [766] (page 78) function is turned on, the converter may restrict power. For the duration of the warning, the value of Thermal integral INV [31] (page 25) is displayed in FAULTS window.
W11-IGBT temperature	High IGBT chip temperature. Chip temperature IGBT chip temp. [673] (page 25) exceeded the value defined by the parameter IGBT chip temp. warning [99] (page 118). If the automatic power restriction Power restriction (PR) [766] (page 78) function is turned on, the inverter can restrict power. Life cycle of the device decreases when the device is overheated excessively and very often. For the duration of the warning, the value of IGBT chip temp. [673] (page 25).
W12-Replace battery	Voltage of the 3V battery of the control card dropped under the 2.7V value. If the battery is not replaced, loss of settings and saved history settings is impending. For the duration of the warning, the value of Battery voltage [773] (page 24) is displayed in FAULTS window.
W13-External temperature	Cooler temperature ETP Temperature [869] (page 23) exceeded the value defined by the parameter ETP Warning [865] (page 112). For the duration of the warning, the value of ETP Temperature [869] (page 23) is displayed in FAULTS window.
W14-IGBT Overheating	Power module is thermally overloaded. Converter operates at high current on high switching frequency. For the duration of the warning, the value of the maximal IGBT current is displayed in FAULTS window.

A sample display	Description
W15-Set date and time	Date and time have not been set.
W16-Uncommissioned converter	The converter has not been fully commissioned yet.
W17-MT Overload	Motor is overloaded - converter integral Thermal integral MT [33] (page 25) exceeded the 90% value and the fault " E29-Motor overload (page 33)" can occur shortly, after which the converter is blocked for a longer time! For the duration of the warning, the value of Thermal integral MT [33] (page 25) is displayed in FAULTS window.
F18-Flux braking	Flux braking function is active, the motor operates at a higher magnetic flux and part of the braking energy is converted to motor heat. For the duration of the warning, the value of Mag. Flux [71] (page 16) is displayed in FAULTS window. Flux braking can be configured in [774] (page 77).
F19-Mechanical brake	Frequency setpoint is held on the brake frequency Brake frequency [522] (page 108) value, until the delay period and brake reaction Brake delay [519] (page 108) or the brake advance time Brake advance [521] (page 108) expire. For the duration of the warning, the value of Brake frequency [522] (page 108) is displayed in FAULTS window.
F20-BM braking	Brake module was activated. Excessive energy is fed to brake resistor, which is converted to heat. More information in the description of [376] (page 77). For the duration of the warning, the value of Voltage DC [46] (page 16) is displayed in FAULTS window.
W21-MT deexcitation	Waiting for the motor field deexcitation after the voltage disconnection. Until the motor is deexcited, start is not possible. Deexcitation period of the motor can be set by the parameter Time constant MT [79] (page 44). For the duration of the warning, the value of Mag. Flux [71] (page 16) is displayed in FAULTS window.
F22-Current limit	Current limit takes up. Current reached the value given by the parameter Max. mot. current [5] (page 75) or Max. regen. current [549] (page 75) and the output frequency along with the voltage is restricted. Motor is accelerating in the regenerative operation and decelerating in the motoric operation. For the duration of the warning, the value of Current MT [42] (page 16) is displayed in FAULTS window.
W23-Rs and Vs identification	Stator resistance and stator voltage identification in effect. If the Rs identification in parameter V/f Identification Rs [383] (page 62) is turned on, motor can stay longer on zero frequency during the first start. For the duration of the warning, the value of Stator resistance [345] (page 44) is displayed in FAULTS window.
F24-Flying start	Flying start in effect. Converter is searching the actual rotor frequency. Flying start can be turned off by parameter Flying start [374] (page 75). For the duration of the warning, the value of Freq. INV [47] (page 15) is displayed in FAULTS window.
W25-Max. voltage	Current controller saturation. Converter is not able to generate more voltage on the output. Upper limit of generated voltage is defined by the parameter Max. voltage [495] (page 75). For the duration of the warning, the value of Voltage MT [73] (page 16) is displayed in FAULTS window.
W26-Max. flux current	Saturation of flux creating current component. Probably a high value of Magnetic Flux setpoint [452] (page 63) is set, or Mutual inductance [441] (page 45) is set too low. Maximum current is set by Max. mot. current [5] (page 75). For the duration of the warning, the value of flux current component is1 is displayed in FAULTS window.
W27-Max. torque current	Saturation of torque creating current component. Motor operates on current limits, defined by Max. mot. current [5] (page 75) and Max. regen. current [549] (page 75). For the duration of the warning, the value of Current MT [42] (page 16) is displayed in FAULTS window.
W28-Max. torque	Saturation of motor torque (see [575] (page 52)). For the duration of the warning, the value of Torque [69] (page 16) is displayed in FAULTS window.
F29-Field weakening	Motor operates in the field weakening zone, to achieve higher frequencies. Motor torque decreases in this mode in reciprocal proportion to the rotation speed. For the duration of the warning, the value of Mag. Flux [71] (page 16) is displayed in FAULTS window.
W30-Min. flux	The magnetic flux has reached its minimal value, the drive is not able to accelerate anymore at this load level. For the duration of the warning, the value of Mag. Flux [71] (page 16) is displayed in FAULTS window.

A sample disley	Description
F31-Dyn. Deceleration	DC link voltage crossed its reference DD setpoint [754] (page 76), the correction changes the deceleration ramp dynamics. Only if Dynamic Deceleration is turned on (Dynamic deceleration (DD) [749] (page 76)). For the duration of the warning, the value of Voltage DC [46] (page 16) is displayed in FAULTS window.
F32-Kinetic backup	DC link voltage falled under KB setpoint [753] (page 76), the correction affects the ramp output. Only if Kinetic backup is turned on (Kinetic backup (KB) [748] (page 76)). For the duration of the warning, the value of Voltage DC [46] (page 16) is displayed in FAULTS window.
W33-Quick STOP	Emergency STOP was activated, after which the START is blocked. Converter will unblock after cancelling the START command with an inactive safety (quick) STOP.
F34-Quick reverse	Accelerated ramp-down Quick reverse is applied on the opposite polarity of the frequency setpoint and the ramp output. For the duration of the warning, the value of Quick reverse [807] (page 74) is displayed in FAULTS window.
W35-PC Parking	Process controller conditions to park the converter were met. For the duration of the warning, the value of Error PC [410] (page 22) is displayed in FAULTS window.
F36-OPS on	Limit switch of the Overload Protection System (OPS) is on. For the duration of the warning, the value of Load [854] (page 22) is displayed in FAULTS window.
F37-OPS detecion	Detection of overload limits. OPS limit switch is disabled. For the duration of the warning, the value of Load [854] (page 22) is displayed in FAULTS window.
W38-Motor disconnected	Motor current is too low. The motor is probably not connected or the motor parameters do not match the connected motor. For the duration of the warning, the value of Current MT [42] (page 16) is displayed in FAULTS window.
W39-Pantograph outage	Voltage drop or outage of the pantograph voltage of the trolley vehicle. For the duration of the warning, the value of Pant/isol V [113] (page 23) is displayed in FAULTS window.
W40-Slip restriction	Converter limited the frequency not to exceed the maximum allowed motor slip. For the duration of the warning, the value of Slip freq. [938] (page 15) is displayed in FAULTS window.
W41-Profibus Timeout	Profibus master does not communicate with the Profibus module, or the Profibus module does not communicate with the converter for a defined period of time PB Warning timeout [815] (page 123).
W42-Modbus Timeout	Modbus master does not communicate with the converter for a defined period of time MB Warning timeout [962] (page 120).
F43-Limit switch 1	Limit switch 1 is switched. Configuration is possible in the group [876] (page 101).
F44-Limit switch 2	Limit switch 2 is switched. Configuration is possible in the group [877] (page 102).
F45-Limit switch 3	Limit switch 3 is switched. Configuration is possible in the group [878] (page 102).
F46-Limit switch 4	Limit switch 4 is switched. Configuration is possible in the group [879] (page 103).
F47-Set switching	Switching to another set is activated. If the message persists, it is not possible to switch the sets (Some parameters can only be changed during stop). For the duration of the warning, the value of [222] (page 124) is displayed in FAULTS window.
F48-Restore point	Restore point for restoring the converter settings is being created.
W49-External warning	External warning signal is active. Source of the warning is configured in the parameter Ext. warning signal [965] (page 118).
W50-CPU Overload	Excessive overload of the converter control processor. Control quality decreases when this warning occurs. It is recommended to decrease the converter switching frequency Switching frequency [6] (page 47). For the duration of the warning, the value of load of the 10ms interrupt is displayed in FAULTS window.
F51-Initialization	During the initialization Initialization time [1154] (page 48) the converter ignores control commands. It is used for slower superior systems.
W52-Brake frequency	Frequency setpoint Freq. setpoint [162] (page 15) is less than Brake frequency [522] (page 108). For the duration of the warning, the value of Brake frequency [522] (page 108) is displayed in FAULTS window.
W53-BM blocking	Blocking the switching pulses of BM from the source BM blocking [1204] (page 77).
F54-Auto on/off	Countdown to auto on/off in progress. For the duration of the warning, the value of ON / OFF time [1577] (page 15) is displayed in FAULTS window.
W55-Waiting for STOP	Waiting for the STOP command. Due to safety reasons, STOP command has to come prior to the START command to start the drive.
W56-Low DC	Low DC link capacity, high voltage ripple.

A sample display	Description
capacity	
W57-IRC outage	Converter is detecting incorrect signals from IRC1 or IRC2. Testing can be turned off in parameter Encoder fault mode [535] (page 115). For the duration of the warning, the value of Freq. IRC1-IRC2 gear [1086] (page 19) is displayed in FAULTS window.
F58-Identification	Identification of motor parameters in progress. For the duration of the warning, the value of Identification status [994] (page 70) is displayed in FAULTS window.
W59-Incorrect IRC/ARC direction	Change the direction of feedback sensor (IRC or ARC). For the duration of the warning, the value of Freq. RT [937] (page 15) is displayed in FAULTS window.
W60-Speed saturation	Torque decreased because of speed saturation. When torque control mode is on, the speed setpoint has been reached, the value of torque Torque [69] (page 16) can differ from torque setpoint Torque setpoint [923] (page 15). For the duration of the warning, the value of Freq. RT [937] (page 15) is displayed in FAULTS window.
W61-Dynamic lift	Dynamic lift limits the maximum frequency according to the actual motor load. DL can be configured in the group [1068] (page 110). For the duration of the warning, the value of Load [854] (page 22) is displayed in FAULTS window.
W62-IRC1,2 difference	Feature of IRC1,IRC2 difference watching evaluated the maximal speed difference and generated RESET or decreased torque according the parameters in IRC1,2 Detuning [1082] (page 113). For the duration of the warning, the value of Freq. IRC1-IRC2 gear [1086] (page 19) is displayed in FAULTS window.
W63-Power reduction	To prevent instability operation of the motor, apparent motor power is reduced. In V/f control mode, power is reduced when the stator frequency exceeds Freq. III. region [1193] (page 62). In vector control mode, power is reduced automatically, independently of the configuration.
W64-Vector control instability	Instability or loss of orientation of vector control. Please, look to Manual for vector control setting.
W65-DC charging SERVOFREM	The DC circuit of the SERVOFREM inverters is being charged. During the warning, the value Voltage DC [46] (page 16) is displayed in the FAULTS window.
W66-Cam position limit	The cam hit its limit and the shape of the cam was distorted.
W67-Speed saturation	Speed saturation during position control. Increasing Setpoint frequency [344] (page 51) could increase the quality of the position control.
W68-Position calibration	Position calibration in progress, controlled by Pos. calib. source [1144] (page 68).
W69-Isolation fault	Insulation fault. It is set in the service parameters.
W70-Low deceleration	Too low Low deceleration limit [685] (page 115) was observed.

6 ERRORS

A sample display	Description
E1-Cooler temperature	Cooler temperature exceeded the allowed limit of temperature. It is necessary to increase the cooling efficiency. For the duration of the fault, the value of Cooler temperature [74] (page 25) is displayed in FAULTS window.
E2-Output phase outage	Converter evaluated the output current asymmetry, which can be caused by interrupting the output phase or damaged connected device. Fault can be turned off in the parameter Output phase loss [338] (page 114), or change its sensitivity in the service parameter "Output phase loss sens.".
E3-IGBT chip temper.	IGBT chip temperature exceeded the allowed limit of temperature. It is necessary to increase the cooling efficiency. For the duration of the fault, the value of IGBT chip temp. [673] (page 25) is displayed in FAULTS window.
E4-Overvoltage	Voltage in DC link exceeded the maximal allowed value, which is factory preset. For the duration of the fault, the value of Voltage DC [46] (page 16) is displayed in FAULTS window.
E5-Undervoltage	Voltage in DC link dropped under the minimal allowed value, which is factory preset. For the duration of the fault, the value of Voltage DC [46] (page 16) is displayed in FAULTS window.
E6-Watchdog PWM	Fault caused by suspending or stopping of the control firmware in the DSP or during the debugging process.
E7-External fault	Signal of an external fault is active. Source of the fault is configured in the parameter Ext. fault signal [527] (page 115).
E8-Converter overload	Converter thermal overload occurred. Load character can be changed using parameter Operation mode [23] (page 48), Permanent current [24] (page 47) and the actual load rate of the converter can be tracked in the quantity Thermal integral INV [31] (page 25). For the duration of the fault, the value of Thermal integral INV [31] (page 25) is displayed in FAULTS window.
E9-System error	Serious converter fault - Call the NON-STOP service line of VONSCH s.r.o.!
E10-Overfrequency	Value Freq. INV [47] (page 15) exceeded the maximal allowed limit defined by the parameter Overfrequency limit [97] (page 114). For the duration of the fault, the value of Freq. INV [47] (page 15) is displayed in FAULTS window.
E11-Overcurrent	Exceeding the maximal allowed output current, whose value depends on the parameter Operation mode [23] (page 48) and the factory preset current overload. For the duration of the fault, the value of Current MT [42] (page 16) is displayed in FAULTS window.
E12-Short circuit	IGBT power module detected the short circuit, which could occur during phase-to-phase or phase-to-ground short circuit on the U,V,W terminals or during an excessive current peak caused by improper installation.
E13-Input phase loss	Converter evaluated unsymmetry of supply voltage phases which can be caused by input phase loss. Fault can be turned off in the parameter Input phase loss [337] (page 114).
E14-Safety input	Safety input on the terminal X1.7 is switched off.
E15-Reserved	Reserved.
E16-Supply overload	Voltage of the supply is outside of the allowed tolerance or a short circuit on the control terminal board occurred. For the duration of the fault, the value of Voltage 24V [72] (page 24) is displayed in FAULTS window.
E17-Brake module short circuit	Brake module evaluated excessive current of the power transistor. The cause can be a BR short circuit or a faulty BM.
E18-Rectifier fault (HW ERR1)	If SKiiP module is used, rectifier fault has occurred. When other type of module is selected, this fault can be interpreted as Reserved HW fault 1.
E19-HW ERR2	Reserved HW error 2
E20-HW ERR3	Reserved HW error 3
E21-Reserved	Reserved.
E22-CB temperature	Maximal converter environment temperature exceeded. Please, increase the cooling efficiency of the converter, or install air conditioning. For the duration of the fault, the value of CB temperature [75] (page 25) is displayed in FAULTS window.
E23-Brake module	Control board interference fault. Possible cause is incorrect converter installation or

A sample display	Description
interference	a strong electromagnetic interference from surrounding devices. Test of this fault can be turned off in service parameters.
E24-Power module interference	Control board interference fault. Possible cause is incorrect converter installation or a strong electromagnetic interference from surrounding devices. Test of this fault can be turned off in service parameters.
E25-Interrupted AIN1	For the defined AIN Type 2 to 10 V (4 to 20mA) the AIN1 value dropped under the 1V or 2mA limit. Indicates the analog input interruption or a control board electronics fault. For the duration of the fault, the value of AIN1 [256] (page 18) is displayed in FAULTS window.
E26-Interrupted AIN2	For the defined AIN Type 2 to 10 V (4 to 20mA) the AIN2 value dropped under the 1V or. 2mA limit. Indicates the analog input interruption or a control board electronics fault. For the duration of the fault, the value of AIN2 [280] (page 18) is displayed in FAULTS window.
E27-Interrupted AIN3	For the defined AIN Type 2 to 10 V (4 to 20mA) the AIN3 value dropped under the 1V or 2mA limit. Indicates the analog input interruption or a control board electronics fault. For the duration of the fault, the value of AIN3 [281] (page 18) is displayed in FAULTS window.
E28-Interrupted AIN4	For the defined AIN Type 2 to 10 V (4 to 20mA) the AIN4 value dropped under the 1V or 2mA limit. Indicates the analog input interruption or a control board electronics fault. For the duration of the fault, the value of AIN4 [282] (page 18) is displayed in FAULTS window.
E29-Motor overload	Excessive thermal overload of the motor. High temperature of the motor evaluation method is set by the parameter Motor overloading [27] (page 114). Actual status of the motor temperature integral is in Thermal integral MT [33] (page 25). For the duration of the fault, the value of Thermal integral MT [33] (page 25) is displayed in FAULTS window.
E30-Current leak/Sum I	Current leak in the motor cable or HW failure of the control board - current measurement fault. Occurs when the value of Sum of I-AC [831] (page 17) exceeds 10% rated converter current. It is recommended to measure leaks in the motor cable. It is possible that the control board is impure by conductive impurities. Please, contact VONSCH company. For the duration of the fault, the sum of phase currents is displayed in FAULTS window.
E31-Too many faults	More faults occurred that specified by the parameter Max. fault count [431] (page 116) in a time period shorter than Min. fault period [432] (page 116). For the duration of the fault, the value of number of faults is displayed in FAULTS window.
E32-IRC fault	IRC outage. Please, check the IRC cable first. IRC fault testing can be turned off in Encoder fault mode [535] (page 115). For the duration of the fault, the value of Freq. IRC1-IRC2 gear [1086] (page 19) is displayed in FAULTS window.
E33-Reserved	Reserved
E34-Reserved	Reserved
E35-Reserved	Reserved
E36-FLASH error	Data could not be written into the FLASH memory. The converter control board might be damaged.
E37-Profibus Timeout	Profibus master does not communicate with the Profibus module, or the Profibus module does not communicate with the converter for a defined period of time PB Fault timeout [814] (page 122).
E38-ETP temperature	Temperature on the external temperature sensor ETP Temperature [869] (page 23) exceeded the value defined by the parameter ETP Fault [866] (page 112). For the duration of the fault, the value of ETP Temperature [869] (page 23) is displayed in FAULTS window.
E39-Settings restored	Converter configuration was not valid (long or improper storage of the converter or incorrect write to the RAM memory), so the parameters were restored from the automatic backup. For the duration of the fault, the date of the last automatic setting backup is displayed in FAULTS window.
E40-Blocked converter.	Converter is blocked, or has invalid settings. If possible, use the restore point to restore settings, otherwise call the VONSCH service.
E41-Pantograph outage	Voltage drop or outage of the pantograph voltage of the trolley vehicle. For the duration of the fault, the value of Pant/isol V [113] (page 23) is displayed in FAULTS window. For special converters only!

A sample display	Description
E42-Modbus Timeout	Modbus master does not communicate with the converter longer than defined period of time MB Fault timeout [659] (page 120). For the duration of the fault, the value of Slave count [801] (page 26) is displayed in FAULTS window.
E43-Blocked rotor	The rotor does not move despite the saturation of the torque or current, this can be caused by a mechanical failure of the sensor, or the rotor is blocked (faulty brake ...). When controlling SMPM, this can also mean incorrect encoder polarity. This fault can be turned on or off by the option "Blocked rotor" in Encoder fault mode [535] (page 115).
E44-Encoder speed step change	The encoder has detected an unlike speed step change. It is probably caused by damaged encoder; however, a huge external torque action is also possible, e.g. mechanical lock of the rotor. This fault can be turned on or off by the option "Speed step change" in Encoder fault mode [535] (page 115).
E45-Reserved	Reserved
E46-Low deceleration	Too low Acceleration m/s ² [684] (page 17) below Low deceleration limit [685] (page 115) was observed.
E47-BM blocking	Blocking the switching pulses of BM from the source BM blocking [1204] (page 77). This fault can be turned off by parameter BM blocking fault [1205] (page 77).
E48-Reserved	Reserved
E49-IGBT Module overheating	IGBT is operated at very low voltage V _{dc} , high frequency of PWM switching or at currents that are not approved by the manufacturer IGBT module. For the duration of this fault, the value of the maximum IGBT current is displayed in FAULTS window.
E50-Current controllers instability	Instable or detuned current controllers. Please, look to Manual for vector control setting.
E51-Vector control instability	Instability or loss of orientation of vector control. Please, look to Manual for vector control setting.
E52-End of the trial period.	The trial period has expired. The motor operation is locked, please contact the supplier of frequency converter or device in which the converter is used, and ask for the conditions for termination of trial operation.
E53-Identification fault	Incorrect result of the motor parameters identification. Please, look to Manual for vector control setting. For the duration of the fault, the cause of the fault Identification fault [1093] (page 70) is displayed in FAULTS window.
E54-ARC fault	ARC fault. Please, check the ARC module connection and the connection cable between the module and the resolver. For the duration of the fault, the value of Status RM_ARC [292] (page 20) is displayed in FAULTS window.
E55-Rectifier fault (VDC)	High value of first or second harmonic of the DC bus voltage.
E56-RM-SERVO fault	Fault of the RM-SERVO extension module or the absolute encoder.
E57-Current measurement fault / Disconnected motor	Current measurement failure or disconnected motor. It occurs when the current regulators are saturated, but the current is relatively low and the voltage is much higher than expected. The sensitivity of this fault can be influenced by the service parameter "Volt. diff. from V/f curve".
E58-SMPM control fault	Incorrect value of Rotor pole position SMPM [1609] (page 47), or Pole pairs [1613] (page 44).
E59-Incorrect IRC/ARC direction	Change the direction of feedback sensor (IRC or ARC), set by Speed source [1000] (page 58). Evaluation of this fault can be disabled by Encoder fault mode [535] (page 115).
E60-High IRC/ARC freq.	Frequency of IRC / ARC feedback greater than the value set in High freq. encoder [1612] (page 116). Evaluation of this fault can be disabled by Encoder fault mode [535] (page 115).
E61-Brake fault SERVOFREM	Failure of brake or 24V brake power supply.
E62-Min position limit	Exceeding the minimum permissible position range when positioning within 1 revolution, e.g. cam.
E63-Max position limit	Exceeding the maximum permissible position range when positioning within 1 revolution, e.g. cam.

7 SETTINGS

Group of parameters number [722]

Settings of the converter parameters, load, management, control, and other components and functions of the frequency converter.

MENU \ SETTINGS

Name [ID]	Description	Def.
Quick setup [1516]	Launches the wizard for quick setup of the converter.	

7.1 Using the quick setup wizard with VONSCH UNIFREM

UNIFREM converters are equipped with the quick setup wizard since the firmware version 3.000. This setup wizard is used to speed up the initial configuration and reliable startup of the motor. The purpose of this wizard is not to replace the need of final adjustment and tuning of the converter, it has to be done manually.

This quick setup wizard can only be used with the control panel UNIPANEL, firmware version 2.061 or higher.

7.1.1 Working with the wizard

The quick setup wizard offers several type of screens, which differ with the behaviour and type of user-machine interaction.

Question

Screen type "question" is used for asking the user a question that can be answered by two possible answers, mostly "yes" and "no". These responses are associated with the "Enter" key and

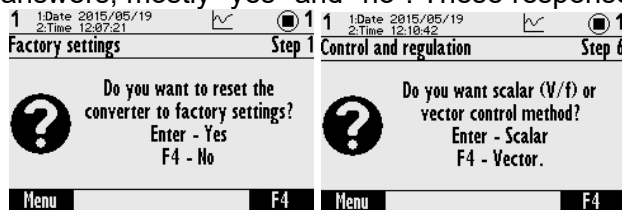

"F4" key. 

Information

Screen type "information" informs the user about the result of an action, whether it was successful or not.

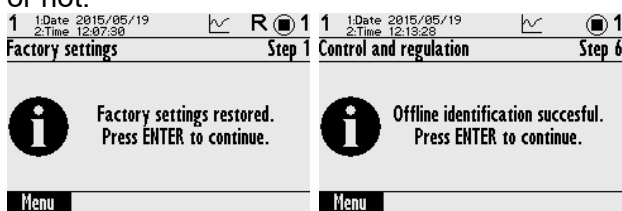

Command list

Screen type "command list" displays a list of several commands, from which the user can choose one. After selecting one, this screen closes.



Parameter list

Screen type "parameter list" shows several parameters that can be freely modified in any order. This screen can be exited using the "F3" key.

UNIFREM v.5.20x

Motor Step 2		Control and regulation Step 6	
Nom. power	1100W	V/f Type	--
Nom. voltage	400.0V	Starting voltage	3.90%
Nom. current	2.80A	End voltage	100.0%
Nom. frequenc..	50.0Hz	Frequency shift	5.0Hz
Nom. revolutio..	1450ot/min	V/f exponent	1.50
Menu	>> Help	Menu	>> Help

Parameter change

The screen "parameter change" prompts to modify single parameter. After changing and pressing "ENTER" key, new value is saved and this screen is closed.

IRC1 pulses Set 1	
1024	
(0 ÷ 40000)	
Menu	Calib. Help

Waiting

Screen "waiting" is used for pending completion of the action. It may wait for user interaction (e.g. start command), or wait to complete some actions in the inverter.

Control and regulation Step 6	Directions and encoder Step 5
For starting the identification, please, run the START command.	Test of motor direction in progress. Please, wait until the drive stops. Press ENTER to continue.
Menu	Menu

7.1.2 Steps of the quick setup wizard

The wizard consists of several steps:

1. **Factory settings**
This step asks about reset of the converter to factory settings.
2. **MOTOR**
Motor nameplate data, using of sine filters, motor cooling.
3. **Application macros**
Allows to choose from five different application macros for different applications.
4. **Command macros**
Allows to choose from sever different command macros for different applications.
5. **Directions and encoder**
In this step the correct direction of rotation of the motor and encoder are determined.
6. **Control and regulation**
In this step the selection of a scalar or vector control and basic control parameters are set. Also parameter identification can be performed.
7. **Basic parameters**
Setting the basic control parameters like max. current, max. voltage, switching frequency and frequency control (acceleration, deceleration and frequency range).
8. **Finish**
Exit the wizard and return to the main menu, where additional settings can be done.

Below in the form of a flow chart, individual steps of setting the converter by wizard can be found. Blocks marked **black** are questions/options or parameters that user can choose. Blocks marked **red** are internal conditions and states, according to the state of the converter, such as used command macro, or the success/failure of performed identification.

7.1.3 Setting the motor data, application and command macro

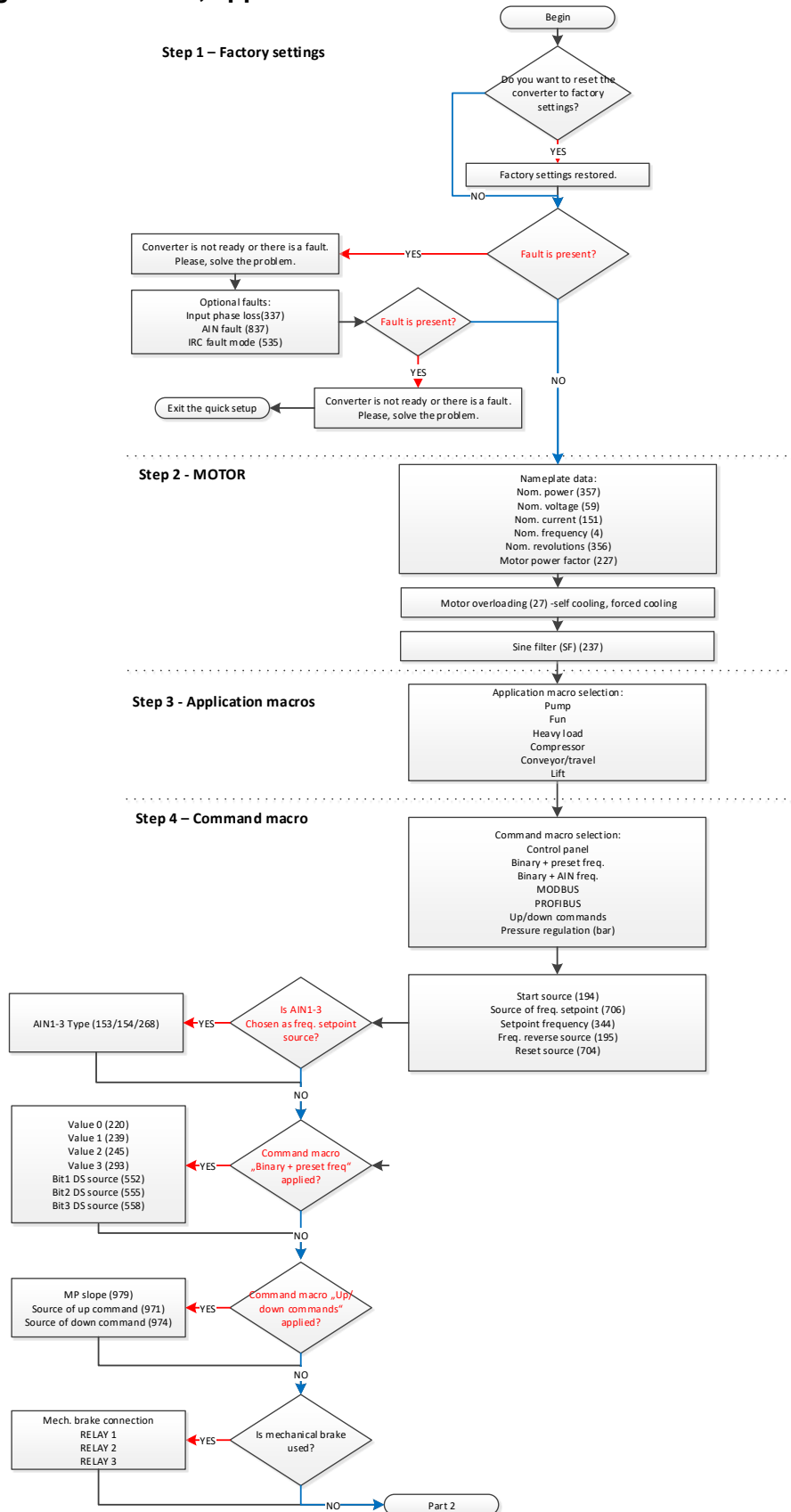

First part of the wizard, Basic motor settings, application and command macro

The first step offers the possibility to reset the converter to factory settings. This action is useful when the inverter was used in the past and its current setting is unknown or untrustworthy.

In the second step, the converter asks for motor nameplate data. After selecting the power, the nearest motor macro is applied, which preconfigures some system parameters.

When changing power, motor voltage or power factor, the system automatically recalculates the nominal motor current to estimated value from the power equation. This automatic preset is suitable for estimating the nominal current in the case where it is not available, e.g. the motor is physically inaccessible or rewound and nameplate data do not match. After you manually change the nominal current value, this value will not be recalculated anymore.

Motor overloading [27]

This parameter is used to preset the motor temperature model. When selecting the "Self-cooling", converter uses thermal model considering its own cooling system, where the cooling effect increases with speed. In case of using "Forced cooling" thermal model considers the forced cooling, the effect is constant. The option "Not evaluated" is recommended where the thermal model should not be evaluated, e.g. when the motor is well cooled or there is another thermal protection. Setting the External Thermal Protection is out of scope of the wizard, it can be set up later.

Sine filter [237]

Is there a sine filter connected between the converter and the motor?

7.1.4 Application macros

UNIFREM offers 5 application macros. They are used to preset some of the essential parameters required for the application. Complete list of these parameters can be found in Table 1 below. The preset value does not need to be suitable for all variants of the application, however it is very simple to change it as needed.

ID	Parameter	Pump	Fan	Compressor	Heavy Load	Conveyor/travel	Lift
23	Operation mode	Variable load	Variable load	Constant load	Constant load	Constant load	Constant load
24	Permanent current	Service settings	Service settings	Service settings	Service settings	Service settings	Service settings
347	V/f Type	ST controller	ST controller	ST controller	ST controller	ST controller	ST controller
91	V/f exponent	1.5	1.5	1	1	1	1
98	Frequency shift	10Hz	10Hz	40Hz	35Hz	35Hz	35Hz
352	Max. current controller	Motoric Auto adaptivity	Motoric Auto adaptivity	Motoric	Motoric Auto adaptivity	-	-
5	Max. mot. current	Nom. motor current (ID151)	Nom. motor current (ID151)	Max. inv. current	Max. inv. current	Max. inv. current	Max. inv. current
549	Max. regen. current	Same as Max. mot. current ID5	Same as Max. mot. current ID5	Same as Max. mot. current ID5	Same as Max. mot. current ID5	Same as Max. mot. current ID5	Same as Max. mot. current ID5
110	Min. frequency	20	20	0	0	0	0
111	Max. frequency	Nom. motor frequency (ID4)	Nom. motor frequency (ID4)	Nom. motor frequency (ID4)	Nom. motor frequency (ID4)	Nom. motor frequency (ID4)	Nom. motor frequency (ID4)
116	Ramp-up 1 time	20	60	5	15	10	5
119	Ramp-down 1 time	20	60	5	15	10	5
807	Quick reverse	100%	100%	100%	100%	100%	100%
766	Power restriction (PR)	- overload - cooler temperature	- overload - cooler temperature - motor overload	- overload - cooler temperature - motor overload	- overload - cooler temperature - motor overload	-	-
748	Kinetic backup (KB)	Turned on	Turned on	Turned off	Turned off	Turned off	Turned off
374	Flying start	Turned off	Turned off	Turned off	Turned off	Turned off	Turned off
346	Brake module	Turned off	Turned off	Turned off	Turned off	Turned on when running	Turned on when running
195	Freq. reverse source	No reverse	No reverse	No change	No change	No change	No change
163	STC Current	0.8 x inverter rated current	0.8 x ID155	60s inverter maximum	60s inverter maximum	60s inverter maximum	60s inverter maximum

UNIFREM v.5.20x

518	Mechanical brake	Turned off	Turned off	Turned off	Turned off	Standard	Standard
697	R1 Source	No change	No change	No change	No change	Brake	Brake
513	Resonance damping	Turned on	Turned on	Turned off	Turned off	Turned off	Turned off

7.1.5 Command macros

UNIFREM offers 7 command macros. They are used to preset some of the typical parameters as the start source, source of frequency setpoint. Complete list of these parameters can be found in Table 2 below. The preset value does not need to be suitable for all variants, however it is very simple to change it as needed.

ID	Parameter	Control panel	Binary + preset freq.	Binary + AIN freq.	MODBUS	PROFIBUS	Up/down commands	Pressure regulation (bar)
194	Start source	Control panel	BIN1, 2	BIN1, 2	MODBUS	PROFIBUS	BIN1	BIN1
704	Reset source	No change	No change	No change	No change	No change	No change	No change
706	Source of freq. setpoint	Control panel	Discrete setpoints	AIN1	MODBUS	PROFIBUS	Up/down commands	Process controller
195	Freq. reverse source	Control panel	BIN2	BIN2	According to the setpoint value	According to the setpoint value	According to the setpoint value	No reverse
No change for pump and fan								
Discrete setpoints:								
576	Discrete setpoint switch	No change	Single	No change	No change	No change	No change	No change
220	Value 0	No change	8 Hz	No change	No change	No change	No change	No change
239	Value 1	No change	15 Hz	No change	No change	No change	No change	No change
245	Value 2	No change	30 Hz	No change	No change	No change	No change	No change
293	Value 3	No change	50 Hz	No change	No change	No change	No change	No change
552	Bit1 source	DS No change	BIN3	No change	No change	No change	No change	No change
555	Bit2 source	DS No change	BIN4	No change	No change	No change	No change	No change
558	Bit3 source	DS No change	BIN5	No change	No change	No change	No change	No change
Up/down commands:								
978	UP/DOWN Type	No change	No change	No change	No change	No change	Type 1	No change
971	Source of up command	No change	No change	No change	No change	No change	BIN3	No change
971	Source of down cmd.	No change	No change	No change	No change	No change	BIN4	No change

As can be seen in the table, the recommended starting source for binary control is BIN1 and BIN2 where BIN1 represents running in the positive direction and BIN2 operation in the negative direction.

At preset speeds (often used by manipulators and cranes), switching between them is done by BIN3, BIN4 and BIN5 where BIN3 represents change to the second speed, BIN4 to the third speed, BIN5 to the fourth speed...

All the key parameters can be changed during the wizard, usually in the next screen after selecting the command macro. Values in the table represent typical and recommended settings.

7.1.6 Directions and the encoder

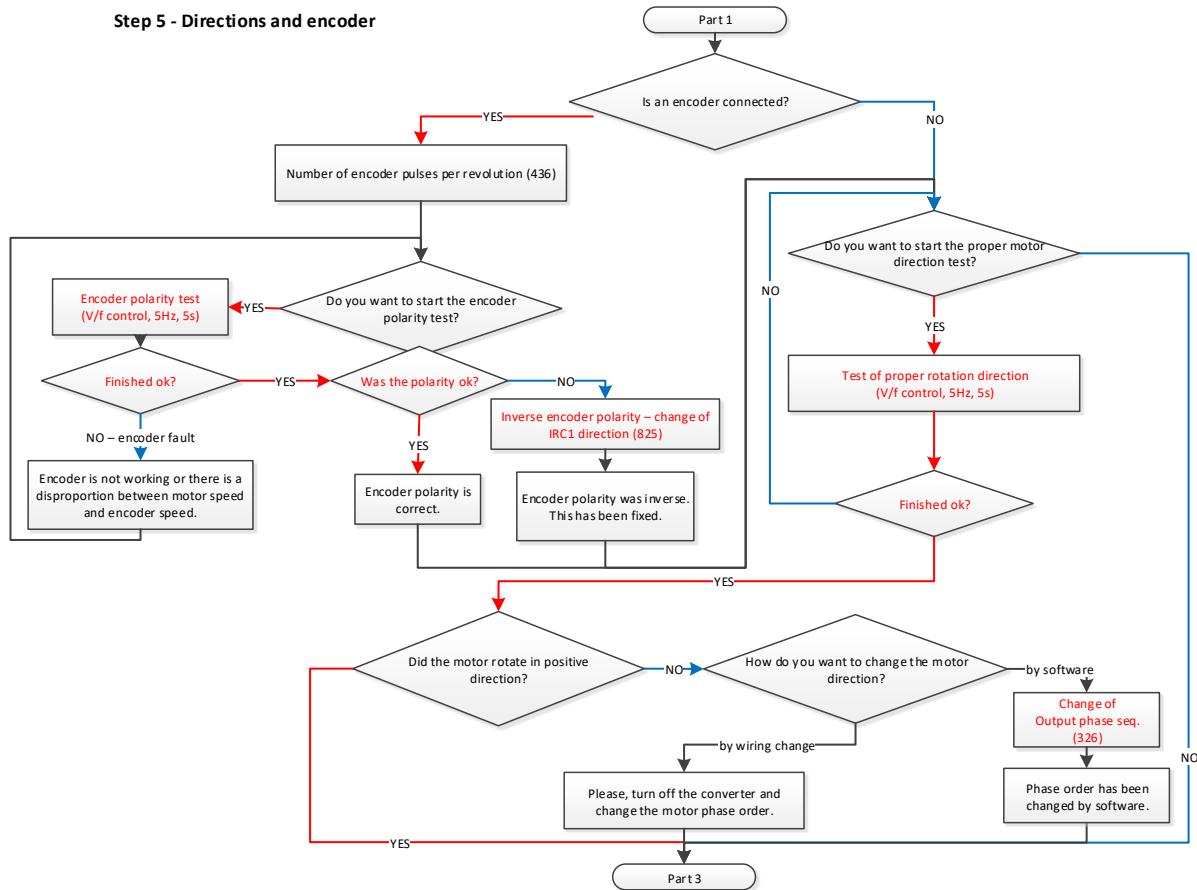

Wizard part 2, encoder and proper directions of the motor

Step 5 is dedicated to the proper motor rotation direction and in case of using the encoder, its synchronization and proper direction as well. If the motor is rotating the wrong way, it is possible to change it by parameter or physically, by swapping two phases on the output terminal.

Note: when choosing the physical change of phase order, for safety reasons first turn off the inverter, wait two minutes and then change the phases.

7.1.7 Control methods, parameter identification, dynamics of the drive

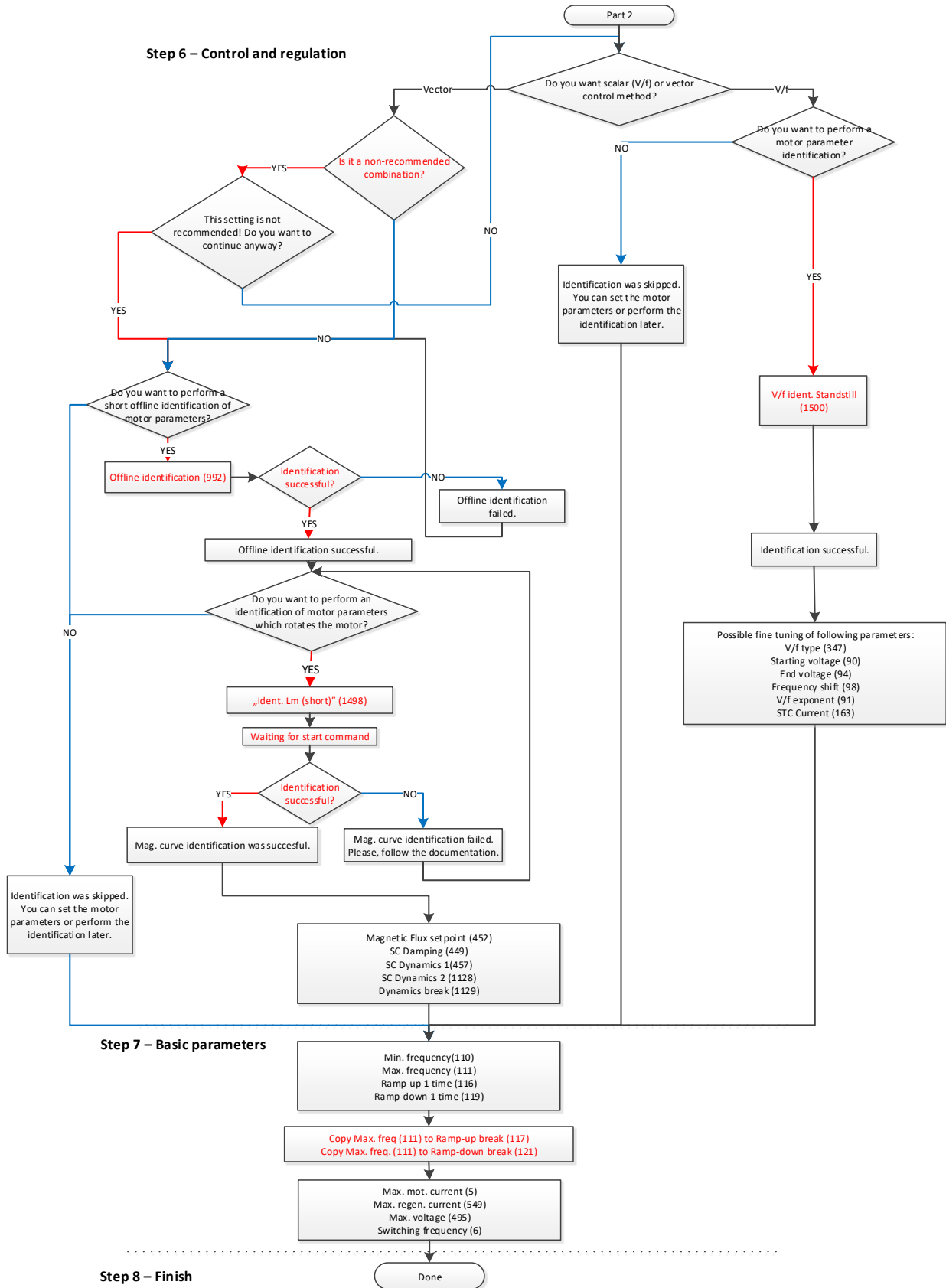

Wizard part 3, Control and identification

In this part the wizard offers two control modes – vector and V/f (scalar).

7.1.7.1. Vector control

Vector control can be divided into open-loop control (without the encoder) and closed-loop control (with the encoder). This is defined by parameter *Motor control method* [451]. The wizard sets this parameter by the result of the question „Is an encoder connected? “.

Wizard can navigate the user through all the required identifications, such as „*Offline identification* [992]“, which is performed at zero speed, and one of two mutual inductance identifications (*Mag. curve identification* [1157] and *Ident. Lm (short)* [1498]), which require rotation of motor.

If required, it is possible to skip all the identifications, however, this option is strongly not recommended.

These identifications and the whole vector control are closer described in the document “Vector control of induction motors for VONSCH® UNIFREM drives”, which might be found at www.vonsch.sk in the Support section.

The wizard can only configure the speed control, position or torque control have to be configured and tuned manually.

7.1.7.2. V/f (scalar) control

V/f (scalar) control is still the preferred choice for most applications for its simplicity and robustness. Since the 3.000 firmware version, there are new identification modes for easy initial setup of the scalar control. If necessary, it is possible to skip them.

V/f ident. full - After entering the START command after 5-20 seconds, the motor accelerates to 25Hz, in the desired direction, then it stops automatically. The START command must be entered manually according to the actual settings. This identification responds to the STOP command, so you can always turn it off.

V/f ident. standstill – Identification will start immediately. Motor will not rotate, only the Stator resistance [345] and Starting voltage [90] will be set.

Wizard offers a choice between the longer identification (full) and shorter DC test (standstill).

Recommendation: If you are able to make the full identification, it is recommended to do so.

7.1.7.3. Drive dynamics (common for V/f and vector control)

After the control is set, the wizard offers setting the frequency ramps and voltage and current limits.

Parameters *Min. frequency* [110], *Max. frequency* [111], *Ramp-up 1 time* [116] and *Ramp-down 1 time* [118] determine the frequency range and dynamics - acceleration and deceleration.

Parameters as *Max. mot. current* [5] and *Max. regen. current* [549] define the limits of the motor current in different operating modes. The parameter *Max. voltage* [495] is used to change the maximum voltage on the motor if there is sufficient DC voltage. *Switching frequency* [6] is the frequency of PWM - transistor switching.

These parameters create the last screen of the wizard, it exits the wizard. Afterwards, the drive can be configured and tuned the standard way.

All parameters are further described in other chapters of this document.

7.2 MOTOR

Group of parameters number [58]

Settings of the parameters of the connected motor or other three-phase appliance on the power terminals of the frequency converter (U,V,W,PE).

7.2.1 MOTOR MACROS

Group of parameters number [672]

MENU \ SETTINGS \ MOTOR \ MOTOR MACROS

Name [ID]	Description	Def.
Induction motors [730]	Parameters of sample induction motors.	
400V/0.06kW 400V/0.09kW 400V/0.12kW 400V/0.18kW 400V/0.25kW 400V/0.37kW 400V/0.55kW 400V/0.75kW 400V/1.1kW 400V/1.5kW 400V/2.2kW 400V/3kW 400V/4kW 400V/5.5kW 400V/7.5kW 400V/11kW 400V/15kW 400V/18.5kW 400V/22kW 400V/30kW 400V/37kW 400V/45kW 400V/55kW 400V/75kW 400V/90kW 400V/100kW 400V/110kW 400V/132kW 400V/160kW 400V/200kW 400V/250kW 400V/315kW		

7.2.2 IDENTIFICATION

Group of parameters number [1497]

Parameters for identification modes for V/f (scalar) and vector mode of operation.

MENU \ SETTINGS \ MOTOR \ IDENTIFICATION

Name [ID]	Description	Def.
Offline identification [992]	Command for the initial (offline) identification of the motor electric parameters. It is used to configure the motor electric parameters and the vector control. Please, look to Manual for vector control setting.	
Preset vector control [991]	Command to preset the control structures of vector control to values corresponding to motor. This command serves for initial setting of the control structures of vector control.	
Ident. Lm [1498]	Identification (measurement) of mutual inductance. After the START command the motor will rotate at the predefined speed to measure the mutual inductance. It is necessary to disconnect the load from the motor shaft.	
V/f standstill ident. [1500]	Short standstill identification of motor parameters for V/f (scalar) control.	
V/f ident. full [1501]	Short identification of motor parameters with rotating motor for V/f (scalar) control. After the START command the motor will rotate at the predefined speed to measure the motor parameters. It is necessary to disconnect the load from the motor shaft.	
Direction test [1502]	Short test of proper rotation direction.	

7.2.3 NAMEPLATE MOTOR PARAMETERS

Group of parameters number [1210]

Values obtained from motor macros or nameplate data.

MENU \ SETTINGS \ MOTOR \ NAMEPLATE MOTOR PARAMETERS

Name [ID]	Description	Def.
Motor type [1610]		Induction motor
Induction motor	Squirrel cage induction motor.	
SMPM	Synchronous motor permanent magnet.	
Nom. power [357]	Nominal motor power, read from the nameplate or catalog data.	1100 W
10 W ÷ 1500000 W	This parameter is required for correct calculation of power and proper operation of slip compensation [348] (page 60).	
Nom. voltage [59]	Nominal voltage of the motor.	400.0 V
1.0 V ÷ 1000.0 V	During the installation, it is necessary to check whether the motor connection (delta, wye) voltage corresponds to this value. There is special case to shorten overload time the motor, when it is allowed to set the wye voltage for a delta connection, while increasing the values of nom. frequency and nom. revolutions to 173% of their original values.	
Nom. frequency [4]	Nominal frequency of the motor.	50.00 Hz
1.00 Hz ÷ 500.00 Hz	In the V/F control mode, this parameter determines the frequency at which the V/f voltage curve reaches the value of End voltage [94] (page 59). Along with these parameters determines the V/f curve voltage and frequency ratio - motor magnetic flux.	
Nom. current	Nominal motor current, read from the nameplate or catalog data.	2.80 A

Name [ID]	Description	Def.
[151]		
0.01 A ÷ 2000.00 A	This parameter determines the value of permanent motor current for motor overload protection Motor overloading [27] (page 114).	
Nom. revolutions [356]	Nominal motor revolutions per minute, read from the nameplate or catalog data.	1450 rpm
100 rpm ÷ 30000 rpm	This parameter is important for proper operation of Slip compensation [349] (page 60) and for calculation of motor pole count Nr of motor poles [1049] (page 46).	
Motor power factor [227]	Nominal power factor of the motor read from the motor nameplate or the catalog data.	0.80
0.40 ÷ 1.00		
Nom. torque [1051]	Nominal mechanical torque on the rotor shaft calculated from the motor nameplate data.	3.00 Nm
-10000.00 Nm ÷ 10000.00 Nm		
Pole pairs [1613]	Number of motor pole pairs calculated from the nominal rpms and the motor frequency for induction motors, it is a parameter for synchronous motors.	2
1 ÷ 1000		
Output phase sequence [326]	Setting the order of the phases on the output of the frequency converter. It replaces the physical exchange of the motor phases if it is necessary to achieve that when the motor should run in the forward direction (REVERSE inactive) it rotates in the opposite direction. It is used to set the desired direction of rotation of the connected motor.	Direct
Direct	Voltage is generated in the U-V-W order.	
Inverted	Voltage is generated in the V-U-W order.	
Reset the motor operation hours MT [1075]	This command resets the operation hours of the motor MT operational hours [497] (page 24).	
Set motohours MT [502]	By changing this parameter, it is possible to preset operation hours of the motor MT operational hours [497] (page 24).	0.0 h
0.0 h ÷ 200000.0 h		

7.2.4 ELECTRICAL PARAMETERS OF THE MOTOR

Group of parameters number [557]

Electrical parameters of the motor, resistances, inductances, magnetic characteristics.

MENU \ SETTINGS \ MOTOR \ ELECTRICAL PARAMETERS OF THE MOTOR

Name [ID]	Description	Def.
Time constant MT [79]	Time constant of the motor excitation.	0.120 s
0.001 s ÷ 10.000 s	This parameter influences the motor excitation speed and is necessary for the correct function of the motor mathematical model. In vector control mode, this parameter is calculated from Rotor resistance [439] (page 45), Mutual inductance [441] (page 45) and Leakage inductance [440] (page 45).	
MT deexcitation time [1171]	Motor deexcitation time after PWM turning off.	1.00
0.00 ÷ 10.00	Represents multiple of Time constant MT [79] (page 44) parameter value, during which PWM outputs are blocked after previous PWM turning off.	
Magnetizing current [355]	Magnetizing current of the motor (I ₀). This parameter has no meaning for SMPM.	2.00 A
0.01 ÷ I _{NK2} ⁴	Correct value of the magnetizing current is generally 30 to 90% of the parameter value Nom. current [151] (page 43). Defines the value of motor excitation in the V/f control mode. ⁴ The value depends on the inverter power line. See installation manual.	
Stator resistance [345]	Stator resistance value. Value of this parameter can come from the motor macros or the identification. For SMPM motor control, this parameter is interpreted as R _d .	6.70000 Ω
0.00001 Ω ÷		

Name [ID]	Description	Def.
100.00000 Ω		
Rotor resistance [439]	Rotor resistance value. Value of this parameter can come from the motor macros or the identification. For SMPM motor control, this parameter has no meaning.	1.00000 Ω
0.00001 Ω ÷ 100.00000 Ω	This parameter is required for the correct operation of the motor mathematical model in the vector control.	
Leakage inductance [440]	Value of the stator leakage inductance. Value of this parameter can come from the motor macros or the identification. On the parameter transfer from older VQFREM converter, it is calculated as (Ls - Lm). For SMPM motor control, this parameter is interpreted as the difference Lq-Ld.	0.1000000 H
0.0000000 ÷ Mutual inductance [441]	This parameter is required for the correct operation of the motor mathematical model in the vector control.	
Mutual inductance [441]	Value of mutual (magnetizing) inductance (Lm). The value of this parameter can come from motor macros, identification or magnetization curve. For SMPM motor control, this parameter is interpreted as Ld.	0.1000000 H
0.0000001 H ÷ 2.0000000 H	This parameter is required for the correct operation of the motor mathematical model in the vector control. Correct value has a great effect on the current stability control.	
Mag. curve [1169]	Activation of motor magnetization curve mode.	Turned off
Turned off	Parameter Mutual inductance [441] (page 45) is considered to be constant.	
Turned on	Parameter Mutual inductance [441] (page 45) is calculated from the magnetization curve and can be different under different values of stator current.	

MAG. CURVE

Group of parameters number [1158]

Settings of the magnetization curve points.

MENU \ SETTINGS \ MOTOR \ ELECTRICAL PARAMETERS OF THE MOTOR \ MAG. CURVE

Name [ID]	Description	Def.
M.C: Lm 1 [1159]	Mutual inductance in point 1.	1.0000000 H
0.0000001 H ÷ 1000.0000000 H		
M.C: Lm 2 [1160]	Mutual inductance in point 2.	1.0000000 H
0.0000001 H ÷ 1000.0000000 H		
M.C: Lm 3 [1161]	Mutual inductance in point 3.	1.0000000 H
0.0000001 H ÷ 1000.0000000 H		
M.C: Lm 4 [1162]	Mutual inductance in point 4.	1.0000000 H
0.0000001 H ÷ 1000.0000000 H		
M.C: Lm 5 [1163]	Mutual inductance in point 5.	1.0000000 H
0.0000001 H ÷ 1000.0000000 H		
M.c:Current [1164] 1	Stator current RMS value in point 1.	1.000 A
0.000 A ÷ 1000.000 A		
M.c:Current [1165] 2	Stator current RMS value in point 2.	1.000 A

Name [ID]	Description	Def.
0.000 A ÷ 1000.000 A		
M.c:Current [1166] 3	Stator current RMS value in point 3.	1.000 A
0.000 A ÷ 1000.000 A		
M.c:Current [1167] 4	Stator current RMS value in point 4.	1.000 A
0.000 A ÷ 1000.000 A		
M.c:Current [1168] 5	Stator current RMS value in point 5.	1.000 A
0.000 A ÷ 1000.000 A		
Coeff. therm. adaptation [1235]	Coefficient of thermal adaptation of motor parameters between the 20 °C and 100 °C. ETP Temperature [869] (page 23) from External Thermal Protection is used as the motor temperature.	1.000
1.000 ÷ 2.000		
Nr of motor poles [1049]	Number of motor poles calculated from the nominal rpms and the motor frequency.	
Nom. slip freq. [1050]	Nominal electric slip frequency calculated from the motor nameplate parameters.	Hz

7.2.5 MECHANICAL PARAMETERS

Group of parameters number [1527]

Mechanical parameters of the system, gear ratios.

MENU \ SETTINGS \ MOTOR \ MECHANICAL PARAMETERS

Name [ID]	Description	Def.
Inertia moment [442]	Estimate of the total motor inertia moment [kg m ²].	0.100000
0.000001 ÷ 1000.000000		
Teeth at gear input (Num.) [1533]	Number of teeth at the gearbox input (input wheel circumference) on the motor side. In older firmware versions referred to as "Num. gear ratio".	1
1 ÷ 32767		
Teeth at gear output (Den.) [1625]	Number of teeth at the gearbox output (output wheel circumference), technology side. In older firmware versions referred to as "Den. gear ratio".	1
1 ÷ 65535		
Gear ratio [888]	Transmission gear ratio. Rotation speed ratio before and after the transmission. It is calculated as the ratio of Teeth at gear output (Den.) [1625] (page 46) and Teeth at gear input (Num.) [1533] (page 46).	1.00000
0.00100 ÷ 10000.00000	Serves for displaying the value of Rpm behind the transmission [907] (page 16) and proper operation of the limit switch functions [875] (page 101). It is also necessary to set Gear ratio [888] (page 46).	
Gear ratio options [1619]	Options of gear ratio settings.	
<input type="checkbox"/> Reserve 0x1	No function.	
<input type="checkbox"/> Enable gear ratio tuning	Enables fine tuning of the gear ratio. Enabling this option can have a negative effect on the accuracy of the calculation, as calculations may be performed in the floating point arithmetics.	
Tune of gear ratio [1626]	Fine tune of gear ratio.	1.0000
0.0100 ÷ 100.0000		
Wheel circumference	It represents the circumference of the wheel behind the transmission. Also serves for displaying the position value and proper operation of the limit	1.0000 m

Name [ID]	Description	Def.
[889]	switch functions [875] (page 101). At the same time it is also necessary to set Gear ratio [888] (page 46).	
0.0001 m 100.0000 m	÷	

7.2.6 SERVOMOTOR (SMPM)

Group of parameters number [797]

Parameters for servomotors and permanent magnet synchronous motors only.

MENU \ SETTINGS \ MOTOR \ SERVOMOTOR (SMPM)

Name [ID]	Description	Def.
Align pole position [20]	Align pole position of synchronous motors. Brake is released during this identification.	
Rotor pole position SMPM [1609]	Rotor pole position at zero electrical angle in degrees.	0.000
-360.000 ÷ 360.000		
Motor const. Nm/A [1534]	Motor constant written on a motor nameplate or in the datasheet, unit is [Nm/A].	1.000
0.000 ÷ 100.000		
Flux PM [1185]	Permanent magnet flux of SMPM [Wb].	0.100 Wb
0.000 Wb ÷ 5.000 Wb		

7.3 CONVERTER PARAMETERS

Group of parameters number [197]

Operating parameters of the converter.

7.3.1 APPLICATION MACROS

Group of parameters number [1491]

Application macros. It configures the converter parameters for the most used applications.

MENU \ SETTINGS \ CONVERTER PARAMETERS \ APPLICATION MACROS

Name [ID]	Description	Def.
Pump [1492]	Application macro for a water pump.	
Fan [1493]	Application macro for a fan.	
Heavy load [1494]	Application macro for a heavy load (extruder).	
Compressor [1557]	Application macro for a piston compressor.	
Conveyor/travel [1495]	Application macro for a conveyor or crane travel/crab.	
Lift [1496]	Application macro for lift applications, like crane lift.	
Switching frequency [6]	Switching frequency of the PWM modulation of output voltages.	3000 Hz
1150 ÷ 10000	Switching frequency of the impulses of the converter power elements. For decreasing the value of acoustic noise, it is possible to increase this value. However, the thermal losses will increase and the maximum current of the converter might decrease.	
Permanent current [24]	The current threshold for a long-term (permanent) converter load. The value represents the ratio between permanent current and the nominal current of the converter.	1.000
0.500 ÷ (I _{NQ} / I _{NK}) ⁵	If output current exceeds this value, the converter can generate the fault " E8-Converter overload (page 32)". Changing the nature of the converter load in the Operation mode [23] (page 48) parameter resets the parameter value to the production value for the specified load type and the specified converter type. By setting this value to higher than factory setting, it allows converter to feed permanently higher current, but it decreases short-term overload factor. ⁵ The value depends on the inverter power line. See installation manual.	

Name [ID]	Description	Def.
Operation mode [23]	Selection of the converter load operation mode. Threshold current for specific operation modes is factory preset.	Constant load
Constant load	Loading mode for dynamically varying loads, which have constant character of the torque to the motor frequency. The drive allows higher short-term overload and lower permanent load. For example: cranes, mills, conveyors, machines...	
Variable load	Loading mode for static loads, which have an exponentially growing character of the torque to the motor frequency. The converter allows lower short-term overload and a higher permanent load. For example : Pumps, Fans, Generators, ...	
Initialization time [1154]	This time extends the initialization time. During the initialization time, start is not possible and the faults are not evaluated. Parameter serves for delaying the response time for slower control systems.	0 s
0 s ÷ 3600 s		
Password [548]	Setting the user password for access to the device settings. Password needs to be entered when entering the converter settings.	****
**** ÷ ****	Protects the converter settings against reconfiguration by unauthorized persons.	
DST Time shift [770]	Determines whether the time of the converter is only in the normal time, or it is changed when needed to normal or daylight saving time.	DST automatic change
No DST DST automatic change		
Converter unblocking [1007]	Parameter for entering the password to unlock the converter from the trial period mode to operation mode. For unblocking the converter, please contact the supplier of frequency converter or device in which the converter is used, and ask for the conditions for termination of trial operation.	****
**** ÷ ****		
Sine filter (SF) [237]	Presence of sine filter at the converters output.	Not present
Not present	SF is not connected to the converter outputs.	
Present	SF is connected to the converter outputs, the lower limit of switching frequency is increased and the dynamics of controllers in vector control mode is reduced.	

7.3.2 ENERGY CONS.

Group of parameters number [236]

Preset or reset of the consumed energy counters kWh Consumption [429] (page 16) a MWh Consumption [430] (page 16).

MENU \ SETTINGS \ CONVERTER PARAMETERS \ ENERGY CONS.

Name [ID]	Description	Def.
Reset the consumption [897]	This command resets the counters of consumed energy.	
Consumption reset source [900]	Special reset source of the consumed converter energy.	
Look choises of parameter's Bit1 DS mask [553] (page 55)		

7.4 COMMANDS

Group of parameters number [1]

Command settings for converter and motor

7.4.1 COMMAND MACROS

Group of parameters number [1503]

Command macros for quick configuration of converter commands.

MENU \ SETTINGS \ COMMANDS \ COMMAND MACROS

Name [ID]	Description	Def.
Control panel [1504]	Command macro for command over the UNIPANEL control panel.	
Binary + preset freq. [1505]	Command macro for command over the binary inputs with discrete preset frequency setpoint values.	
Binary + AIN freq. [1506]	Command macro for command over the binary inputs with setpoint frequency over the analog input.	

Name [ID]	Description	Def.
MODBUS [1507]	Command macro for command over MODBUS industrial protocol.	
PROFIBUS [1508]	Command macro for command over PROFIBUS industrial protocol.	
Up/down commands [1509]	Command macro for command over the up (increase frequency) and down (decrease frequency) commands.	
Pressure regulation (bar) [1510]	Command macro for pressure control over the inbuilt process controller (PID).	

7.4.2 START STOP RESET

Group of parameters number [192]

MENU \ SETTINGS \ COMMANDS \ START STOP RESET

Name [ID]	Description	Def.
Start source [194]	Setting the converter start source. The START command generates the desired voltage and frequency on the U,V,W outputs (or U,V for a single phase load).	BIN1
Control panel	Pressing the green START button on the control panel causes the converter to start. The start is canceled by pressing the red STOP button.	
Permanent start	The converter starts immediately after the switch-on.	
BIN1	The converter start after the activation of the 1st binary input.	
BIN2	The converter starts after the activation of the 2nd binary input.	
BIN3	The converter starts after the activation of the 3rd binary input.	
BIN1, 2	The converter starts after the activation of the 1st or 2nd binary input.	
BIN1, 3	The converter starts after the activation of the 1st or 3rd binary input.	
BIN1, 4	The converter starts after the activation of the 1st or 4th binary input.	
MODBUS	The converter start is controlled over the serial communication. See the MODBUS serial communication protocol.	
PROFIBUS	The converter start is controlled over the serial communication. See the PROFIBUS serial communication protocol.	
Special	The converter start is controlled by a special preset signal and switching thresholds, see [987] (page 50).	
MODBUS 2	The converter start is controlled over the serial communication. See the MODBUS serial communication protocol.	
Reset source [704]	Setting the converter reset source. PWM generating will be turned off. It can be used as an emergency stop. No fault will be generated, only a warning. RESET is needed for example in applications where the motors are switched at the output. Before switching the power output, PWM outputs should be blocked, otherwise there is a high risk of damage to the power elements of the converter.	BIN4
Look choices of parameter's Quick stop source. [986] (page 49)		
Quick stop source. [986]	Setting the source of the quick stop. It is necessary to cancel and then start the converter start command again for the converter to start after a quick stop. It is used to stop the machinery with working personnel, which comes into contact with the rotating parts. For example, signal light barrier or door limit switch. When active, the drive will stop by following the faster deceleration ramp, defined by the time parameter Quick STOP [806] (page 49).	None
None	Function is inactive.	
BIN1	Function is activated by activation of the 1st binary input.	
BIN2	Function is activated by activation of the 2nd binary input.	
BIN3	Function is activated by activation of the 3rd binary input.	
BIN4	Function is activated by activation of the 4th binary input.	
BIN5	Function is activated by activation of the 5th binary input.	
BIN6	Function is activated by activation of the 6th binary input.	
Special	Function is activated by a special preset signal and switching thresholds	
Quick STOP [806]	Relative value of ramp-down time when activating the Quick stop Quick stop source. [986] (page 49).	10.0 %
0.1 % ÷ 100.0 %		

SPECIAL SETTING

Group of parameters number [215]
Special source setting for the START, STOP and RESET.

SPECIAL START

Group of parameters number [987]
Special source setting of Start.

MENU \ SETTINGS \ COMMANDS \ START STOP RESET \ SPECIAL SETTING \ SPECIAL START

Name [ID]	Description	Def.
Start signal [503]	Selection of the signal for Start control.	[184] Binary inputs
Signal		
Start active [504]	The condition for activation the Start.	BIN1
Look choises of parameter's Binary inputs [184] (page 18)		
Start inactive [505]	The condition for deactivation the Start, when selected signal is of numeric type "value".	
Look choises of parameter's Binary inputs [184] (page 18)		

SPECIAL RESET

Group of parameters number [333]
Special RESET setting.

MENU \ SETTINGS \ COMMANDS \ START STOP RESET \ SPECIAL SETTING \ SPECIAL RESET

Name [ID]	Description	Def.
Reset signal [524]	Selection of the signal for RESET control.	[184] Binary inputs
Signal		
Reset active [525]	The condition for activation of RESET.	BIN4
Look choises of parameter's Binary inputs [184] (page 18)		
Reset inactive [526]	The condition for deactivation of RESET, when selected signal is of numeric type "value".	
Look choises of parameter's Binary inputs [184] (page 18)		

SPECIAL QUICK STOP

Group of parameters number [989]
Setting the special source of the Quick Stop.

MENU \ SETTINGS \ COMMANDS \ START STOP RESET \ SPECIAL SETTING \ SPECIAL QUICK STOP

Name [ID]	Description	Def.
Quick stop signal [821]	Selection of the signal for Quick Stop control.	[184] Binary inputs
Signal		
Quick stop active [822]	The condition for activation of Quick Stop.	
Look choises of parameter's Binary inputs [184] (page 18)		
Quick stop inactive [823]	The condition for deactivation of Quick Stop, when selected signal is of numeric type "value".	
Look choises of parameter's Binary inputs [184] (page 18)		
Start delay	Delay between receiving START command and its execution.	0.000 s

Name [ID]	Description	Def.
[1238]		
0.000 s ÷ 300.000 s		
Stop delay [1487]	Delay between receiving STOP command and its execution.	0.000 s
0.000 s ÷ 300.000 s		
STOP timeout [926]	Timeout for instantaneous tripping of the voltage after a STOP command and not reaching the zero speed when the value of Stop type [836] (page 69) is "Ramp-down" or "Step to 0" in vector control, or in V/f control when "Regenerative" is selected in Max. current controller [352] (page 61).	30.0 s
0.0 s ÷ 3600.0 s	In control modes when due to regenerative torque or current saturation after the STOP command the decreasing of the frequency is not possible, the timer for this timeout is increasing. If the speed does not decrease to 0 and the drive is stopped the normal way, the inverter will trip the voltage even at non-zero speed.	

7.4.3 FREQUENCY SETPOINT

Group of parameters number [7]

Setting of frequency setpoint of the converter.

MENU \ SETTINGS \ COMMANDS \ FREQUENCY SETPOINT

Name [ID]	Description	Def.
Source of freq. setpoint [706]	Setting the source of the frequency setpoint.	AIN1
Value	The source of the setpoint is fixed value.	
Control panel	The source of the setpoint are arrow keys in the MONITOR window in the control panel.	
AIN1	The source of the setpoint is the corresponding analog input.	
AIN2	The source of the setpoint is the corresponding analog input.	
AIN3	The source of the setpoint is the corresponding analog input.	
AIN4	The source of the setpoint is the corresponding analog input.	
Discrete setpoints	The source of the setpoint are the discrete setpoint values [60] (page 54). It is not possible to select this setting if the discrete setpoint speeds are assigned elsewhere (e.g. Source of PC setpoint [130] (page 104)).	
Up/down commands	The source of the setpoint are the up/down commands, please see [970] (page 56).	
Process controller	The source of the setpoint is the process controller, please see [385] (page 103).	
MODBUS	The source of the setpoint is the MODBUS serial communication, please see [658] (page 119).	
PROFIBUS	The source of the setpoint is the PROFIBUS serial communication, please see [812] (page 122).	
Special	The source of the setpoint is the special setting.	
Maximal value	The source of the setpoint is the maximum value of the quantity range.	
Setpoint frequency [344]	Fixed value of the setpoint frequency.	0.00 Hz
Min. ⁷ ÷ Max. frequency [111]	⁷ Value depends on the parameter Freq. reverse source [195] (str. 51). For the choice „According to the setpoint value“ is from -(Max. frequency [111] (str. 73)) , for other choices is from Min. frequency [110] (str. 73) .	
Freq. reverse source [195]	Setting the reverse source of the motor frequency setpoint.	BIN6
Control panel	Pressing the gray REVERSE button on the control panel causes the motor reverse.	
No reverse	The motor will always turn in a positive direction, it is the forward direction.	
Permanent reverse	The motor will always turn in a negative direction, it is the backward direction.	
BIN1	Reverse is activated by 1st binary input.	
BIN2	Reverse is activated by 2nd binary input.	
BIN3	Reverse is activated by 3rd binary input.	
BIN4	Reverse is activated by 4th binary input.	

Name [ID]	Description	Def.
BIN5	Reverse is activated by 5th binary input.	
BIN6	Reverse is activated by 6th binary input.	
According to the setpoint value	Rotating direction is dependent on the frequency setpoint polarity Setpoint frequency [344] (page 51).	
MODBUS	The motor reverse is controlled over the serial communication. See the MODBUS serial communication protocol.	
PROFIBUS	The motor reverse is controlled over the serial communication. See the PROFIBUS serial communication protocol.	
Special	The motor reverse is controlled by the special setting [988] (page 52).	
Fsetpoint reset in stop [1152]	Method of frequency setpoint channel storing or reset.	No
No	Frequency setpoint always equals the selected source.	
Yes	While in stop, the setpoint frequency is always set to 0 Hz.	
Fsetpoint transfer [1153]	Setting the behavior of freq. setpoint	During power off
<input checked="" type="checkbox"/> During power off	The converter keeps the setpoint value after the power off.	
<input type="checkbox"/> During set change	Setpoint value is transferred between the parameter sets.	

SPECIAL SETTING

Group of parameters number [988]

Setting a special source for the frequency setpoint and reverse.

MENU \ SETTINGS \ COMMANDS \ FREQUENCY SETPOINT \ SPECIAL SETTING

Name [ID]	Description	Def.
Freq. setpoint signal [30]	Selection of the parameter that represents the frequency setpoint value.	[256] AIN1
Signal		
F Reverse signal [506]	Selection of the signal for Reverse control.	[184] Binary inputs
Signal		
Reverse F active [507]	The condition for activating the Reverse.	BIN6
Look choises of parameter's Binary inputs [184] (page 18)		
Reverse F inactive [508]	The condition for deactivation of Reverse, when selected signal is of numeric type "value".	
Look choises of parameter's Binary inputs [184] (page 18)		

7.4.4 TORQUE SETPOINT

Group of parameters number [575]

Setting of torque setpoint. It serves as the setpoint value for the torque vector control, or as a dynamic constraint for the speed and position vector control.

MENU \ SETTINGS \ COMMANDS \ TORQUE SETPOINT

Name [ID]	Description	Def.
Source of the torque setpoint [1053]	Setting the source of the torque setpoint.	Maximal value
Look choises of parameter's Source of freq. setpoint [706] (page 51)		
Torque setpoint [920]	Torque setpoint value.	0.00 Nm
Min. ⁸ ÷ Max. torque M [481]	⁸ Value depends on the parameter Source of the torque reverse [922] (str. 52). For the choice „According to the setpoint value“ is from -(Max. torque M [481]) (str. 53), for other choices is from Min. torque [482] (str. 53).	
Source of the torque reverse	Setting the reverse source of the torque setpoint.	No reverse

Name [ID]	Description	Def.
[922]		
Look choises of parameter's Freq. reverse source [195] (page 51)		

SPECIAL SETTING TORQ. SP.

Group of parameters number [644]

Special setting of entering the torque setpoint.

MENU \ SETTINGS \ COMMANDS \ TORQUE SETPOINT \ SPECIAL SETTING TORQ. SP.

Name [ID]	Description	Def.
Torque setpoint signal [921]	Selection of the parameter that represents the torque setpoint value.	[256] AIN1
Signal		
Torque reverse signal [654]	Selection of the signal for Torque Reverse control.	-
Signal		
Torque reverse active [655]	The condition for activation of Torque Reverse.	-
- ÷ -		
Torque reverse inactive [656]	The condition for deactivation of Torque Reverse, when selected signal is of numeric type "value".	-
- ÷ -		
Max. torque M [481]	Maximal torque setpoint, motoric mode of operation.	1000.0 Nm
0.0 Nm ÷ 10000.0 Nm	Lower value can reduce torque stress on the rotor shaft and connected mechanical parts. In torque control mode it also defines the upper limit of the torque setpoint Torque setpoint [920] (page 52).	
Min. torque [482]	Minimal torque setpoint.	0.0 Nm
0.0 ÷ Max. torque M [481]	This parameter only applies in the torque control of the motor and defines the lower limit of the torque setpoint Torque setpoint [920] (page 52).	
Reg. torque limit mode [1598]	A source of limiting the regenerative torque. It helps to maintain backward compatibility with older UNIFREM versions.	Regen./motor. Tmax
Regen./motor. Tmax	The Regen./motor. Tmax [484] (page 53) parameter is used to limit the regenerative torque.	
Max. torque Reg.	The Max. torque Reg. [1599] (page 53) parameter is used to limit the regenerative torque.	
Regen./motor. Tmax [484]	Limit ratio of the maximal torque in the regenerative mode compared to the maximal torque in the motoric mode of the operation.	1.000
0.000 ÷ 100.000	It allows to adjust the ratio between the maximal limit of the generator mode compared to the motor mode. For example, in the traction drive of an electric locomotive by value of this parameter lower than one, decreasing of the braking force compared to the tractive force is achieved.	
Max. torque Reg. [1599]	Maximal torque setpoint, regenerative mode of operation.	0.0 Nm
0.0 Nm ÷ 10000.0 Nm		

7.4.5 POSITION SETPOINT

Group of parameters number [1135]

Adjusting the position setpoint. Only for position vector control method.

MENU \ SETTINGS \ COMMANDS \ POSITION SETPOINT

Name [ID]	Description	Def.
Pos. source [1136]	Source of the position setpoint. The position unit is given by the parameter Position unit [1540] (page 67).	Value
Look choises of parameter's Source of freq. setpoint [706] (page 51)		
Pos. setpoint	Fixed value of the position setpoint in revolutions.	0.0000 rev

Name [ID]	Description	Def.
[1137]		
Lower position limit → Upper position limit	Position limits are dependent on Position unit [1540] (str. 67) a Positioning modes [1151] (str. 67).	
Pos. setpoint signal [1138] Signal	Selection of the parameter, which is interpreted as the position setpoint.	[256] AIN1
Max. position setpoint [1140]	Maximum position in revolutions.	360.0000 rev
Lower position limit → Upper position limit	It represents the upper limit of position setpoint channel Pos. setpoint [1137] (page 53). <i>Position limits are dependent on Position unit [1540] (str. 67) a Positioning modes [1151] (str. 67).</i>	
Min. position setpoint [1139]	Minimum position in revolutions.	0.0000 rev
Lower position limit → Upper position limit	It represents the lower limit of position setpoint channel Pos. setpoint [1137] (page 53). <i>Position limits are dependent on Position unit [1540] (str. 67) a Positioning modes [1151] (str. 67).</i>	

7.4.6 DISCRETE SETPOINTS

Group of parameters number [60]

Discrete setpoint value setting.

Discrete setpoint values can serve as the setpoint values signals for any quantity as exact, predefined values.

MENU \ SETTINGS \ COMMANDS \ DISCRETE SETPOINTS

Name [ID]	Description	Def.
Discrete setpoint switch [576]	Discrete setpoint value switch type setting.	Single
Combined	Only the first 3 bits of the DS switch are used. Output value corresponds to the binary combination of these bits. If no bits are active, the Value Value 0 [220] (page 54) is on the output. If only 1 bit is active, the Value Value 1 [239] (page 54) is on the output and so on.	
Single	Every single bit of the DS switch stands for one discrete setpoint value (1.bit stands for the 1. value and so on.). If there are more DS switches active, value with the higher switching bit is on the output. If no DS switch is active, discrete value 0 is on the output.	

DISCRETE VALUES

Group of parameters number [84]

Single discrete value setting. It is possible to set the value only when the signal Discrete setpoint [10] (page 15) is connected. Physical dimension and range of values are inherited according to the target where the signal is connected.

Warning! When configuring speed control of a crane drive, it might be necessary to set Value 0 [220] (page 54) a Value 1 [239] (page 54) to the same value.

MENU \ SETTINGS \ COMMANDS \ DISCRETE SETPOINTS \ DISCRETE VALUES

Name [ID]	Description	Def.
Value 0 [220] - ÷ -	Zero value of the discrete setpoint value. This value applies, when no switch bit is set.	-
Value 1 [239] - ÷ -	First value of the discrete setpoint value.	-
Value 2 [245] - ÷ -	Second value of the discrete setpoint value.	-
Value 3 [293] - ÷ -	Third value of the discrete setpoint value.	-
Value 4 [475] - ÷ -	Fourth value of the discrete setpoint value.	-
Value 5 [299]	Fifth value of the discrete setpoint value.	-

Name [ID]	Description	Def.
- ÷ -		
Value 6 [550]	Sixth value of the discrete setpoint value.	-
- ÷ -		
Value 7 [551]	Seventh value of the discrete setpoint value.	-
- ÷ -		

DS SWITCH

Group of parameters number [100]

Binary switch setting for switching the discrete setpoint values.

MENU \ SETTINGS \ COMMANDS \ DISCRETE SETPOINTS \ DS SWITCH

Name [ID]	Description	Def.
Bit1 DS source [552]	Bit source setting for the binary switch for the discrete setpoint values. Its function depends on the Discrete setpoint switch [576] (page 54) parameter setting. Look choises of parameter's Quick stop source. [986] (page 49)	None
Bit2 DS source [555]	See Bit1 DS source [552] (page 55). Look choises of parameter's Quick stop source. [986] (page 49)	None
Bit3 DS source [558]	See Bit1 DS source [552] (page 55). Look choises of parameter's Quick stop source. [986] (page 49)	None
Bit4 DS source [561]	See Bit1 DS source [552] (page 55). Look choises of parameter's Quick stop source. [986] (page 49)	None
Bit5 DS source [564]	See Bit1 DS source [552] (page 55). Look choises of parameter's Quick stop source. [986] (page 49)	None
Bit6 DS source [567]	See Bit1 DS source [552] (page 55). Look choises of parameter's Quick stop source. [986] (page 49)	None
Bit7 DS source [570]	See Bit1 DS source [552] (page 55). Look choises of parameter's Quick stop source. [986] (page 49)	None

SPECIAL SETTING DS

Group of parameters number [235]

Binary switch special setting.

MENU \ SETTINGS \ COMMANDS \ DISCRETE SETPOINTS \ DS SWITCH \ SPECIAL SETTING DS

Name [ID]	Description	Def.
Bit1 DS mask [553]	Binary switch bit will be active if at least one of the selected binary inputs or logical blocks will be active.	
<input type="checkbox"/> BIN1		
<input type="checkbox"/> BIN2		
<input type="checkbox"/> BIN3		
<input type="checkbox"/> BIN4		
<input type="checkbox"/> BIN5		
<input type="checkbox"/> BIN6		
<input type="checkbox"/> Logical block1		
<input type="checkbox"/> Logical block2		
<input type="checkbox"/> Logical block3		
<input type="checkbox"/> Logical block4		
<input type="checkbox"/> Logical block5		
<input type="checkbox"/> Logical block6		

Name [ID]	Description	Def.
<input type="checkbox"/> Logical block7		
<input type="checkbox"/> Logical block8		
<input type="checkbox"/> Active	Always active. It can be used as logical 1.	
Bit2 DS mask [556]	See Bit1 DS mask [553] (page 55).	
Look choises of parameter's Bit1 DS mask [553] (page 55)		
Bit3 DS mask [559]	See Bit1 DS mask [553] (page 55).	
Look choises of parameter's Bit1 DS mask [553] (page 55)		
Bit4 DS mask [562]	See Bit1 DS mask [553] (page 55).	
Look choises of parameter's Bit1 DS mask [553] (page 55)		
Bit5 DS mask [565]	See Bit1 DS mask [553] (page 55).	
Look choises of parameter's Bit1 DS mask [553] (page 55)		
Bit6 DS mask [568]	See Bit1 DS mask [553] (page 55).	
Look choises of parameter's Bit1 DS mask [553] (page 55)		
Bit7 DS mask [571]	See Bit1 DS mask [553] (page 55).	
Look choises of parameter's Bit1 DS mask [553] (page 55)		

7.4.7 UP/DOWN COMMANDS

Group of parameters number [970]

Up/down commands serves for entering the setpoint value using the up (increase) and down (decrease) commands.

MENU \ SETTINGS \ COMMANDS \ UP/DOWN COMMANDS

Name [ID]	Description	Def.
UP/DOWN Type [978]	Defines the type of Up/Down commands function.	Type 1
Type 1	Both the up and down commands are applied. Converter stores the last set value in the memory. Stands for the common motor-potentiometer in the VQFREM converters.	
Type 2	Only the up command is applied. The down command is applied automatically on the converter stop. Converter does not store the last set value in the memory. Stands for the common memory motor-potentiometer in the VQFREM converters.	
MP slope [979]		0.01 %/s
0.01 %/s ÷ 100.00 %/s		
Source of Up command [971]	Setting the source for the up command.	None
Look choises of parameter's Quick stop source. [986] (page 49)		
Source of Down command [974]	Setting the source for the down command.	None
Look choises of parameter's Quick stop source. [986] (page 49)		

SPECIAL SETTING

Group of parameters number [138]

Special source setting for up and down commands.

MENU \ SETTINGS \ COMMANDS \ UP/DOWN COMMANDS \ SPECIAL SETTING

Name [ID]	Description	Def.
Up mask [972]	Up command will be active if at least one of the selected binary inputs or logical blocks will be active.	
Look choises of parameter's Bit1 DS mask [553] (page 55)		
Down mask	Down command will be active if at least one of the selected binary inputs or logical	

Name [ID]	Description	Def.
[975]	blocks will be active.	
Look choises of parameter's Bit1 DS mask [553] (page 55)		

7.4.8 AUTO OFF

Group of parameters number [1569]
Parameters of automatic off.

MENU \ SETTINGS \ COMMANDS \ AUTO OFF

Name [ID]	Description	Def.
Auto off mode [1572]	Selecting the one or more variables for auto off feature. Any of the selected variables can trigger auto off, whichever fulfills the conditions first.	
<input type="checkbox"/> Low power <input type="checkbox"/> Low frequency <input type="checkbox"/> Low Cos Phi <input type="checkbox"/> Spec. signal		
Min. power [1573]	If the value of Power [66] (page 16) does not exceed this value for the time set by Meas. time [1570] (page 57), auto off is performed. Negative values of this parameter represent minimum regenerative power.	0 W
-3000000 W ÷ 3000000 W		
Min. frequency [1574]	If the value of Freq. INV abs. [472] (page 16) does not exceed this value for the time set by Meas. time [1570] (page 57), auto off is performed.	10.00 Hz
0.00 ÷ Max. frequency [111]		
Min. cos phi [1575]	If the value of Cos Phi [67] (page 16) does not exceed this value for the time set by Meas. time [1570] (page 57), auto off is performed. Negative values of this parameter represent minimum regenerative power factor.	0.500
-1.000 ÷ 1.000		
Spec. signal [1576]	If the corresponding signal is active longer than the time set by Meas. time [1570] (page 57), auto off is performed.	
Look choises of parameter's Logical blocks [8] (page 21)		
Meas. time [1570]	Measurement time; minimal period of time for the any of the auto off conditions to be fulfilled to perform auto off.	1.0 min
0.1 min ÷ 240.0 min		
Off time [1571]	Off time after auto-off. After the expiration of this timer after auto-off, inverter starts and tries again whether the run conditions are met. Time to next start is shown in ON / OFF time [1577] (page 15).	30.0 min
0.0 min ÷ 10080.0 min		
If the value is set to 0, inverter never automatically starts again. Next start can be anytime initiated by cancelling and resending the Start command or by a short Reset command.		

7.5 CONTROL AND REGULATION

Group of parameters number [11]
Settings of the motor control parameters.

7.5.1 CONTROL METHOD

Group of parameters number [450]
Control mode setting.

MENU \ SETTINGS \ CONTROL AND REGULATION \ CONTROL METHOD

Name [ID]	Description	Def.
Motor control method [451]	Setting the motor control method. Individual control methods differ by principle, control quality, robustness and difficulty to setup.	V/f open
V/f open	V/f control (scalar) without the speed feedback. Less accurate slip compensation. High stability and robustness of the control. Suitable for pumps, fans, conveyors and low momentum applications.	
V/f closed	V/f control (scalar) with the speed feedback from the motor rotation speed (IRC sensor). Accurate slip compensation with a higher control quality, mainly at low	

Name [ID]	Description	Def.
	speed. Suitable for applications with lower requirements for the dynamics of regulation. Very simple configuration.	
VIM closed	Dynamic vector motor control with the rotation feedback designed for induction motor, where the FLUX and the TORQUE of the motor are controlled using the motor mathematical model. For high-demanding applications, where fast and exact control of torque and speed is required, e.g. CNC machines, lift, elevators, traction drives. The source of the feedback is set by the parameter Speed source [1000] (page 58).	
VIM open	Dynamic vector motor control without the rotation feedback designed for induction motor. Current motor speed is evaluated from the mathematical model. This control is of worse quality in the zero frequency vicinity. Because of this it is not suitable for applications where the motor has to hold the desired speed in the zero vicinity at the very high load.	
V-SMPM	Dynamic vector motor control with the rotation feedback designed for permanent magnet synchronous motors, at which the FLUX and the TORQUE of the motor are controlled using the motor mathematical model. For applications, where quick and accurate control of the motor speed and torque are required. Requires special rotor position sensor types! Its setting is in the group [826] (page 89).	
Control type [835]	Selection of main controlled quantity. Position, speed or torque.	Speed
Position	Main controlled quantity is the rotor position Position [1636] (page 17).	
Speed	Main controlled quantity is the rotor speed Freq. RT [937] (page 15).	
Torque	Main controlled quantity is the motor torque Torque [69] (page 16).	
Speed source [1000]	Setting the rotor speed calculation method, which will be used for mathematical models and speed regulation.	IRC1
IRC1	Speed feedback is taken from IRC1.	
IRC2	Speed feedback is taken from IRC2.	
Min(IRC1,IRC2)	Speed feedback is taken as a minimum from IRC1 and IRC2.	
Max(IRC1,IRC2)	Speed feedback is taken as a maximum from IRC1 and IRC2.	
Average(IRC1,IRC2)	Speed feedback is taken as an average between IRC1 and IRC2.	
ARC	Speed feedback is read from the absolute position sensor extension module.	
Special	The source of the actual speed is the parameter value Special speed [1002] (page 58).	
None/Model	The source of the actual speed is the mathematical model of the speed.	
Special speed [1002]	Parameter that represents the special source of the real rotor speed as an alternative source of the measured speed.	0.00 Hz
-1000.00 Hz ÷ 1000.00 Hz	If there is need to regulate the speed using the speed voltage generator, its output connects to an analog input. In special settings of this input this parameter will be selected as a signal, where the AIN should log. It can be used to configure backup and support signals in some special applications.	
Position source [1141]	Selecting the source of the position feedback (Position [1636] (page 17)).	IRC1
IRC1	Position feedback is evaluated from IRC1.	
reserved 0x2		
IRC1-IRC2	Position feedback is evaluated as the difference of IRC1 and IRC2.	
ARC	Position feedback is evaluated from the absolute position sensor.	
reserved 0x10		
ARC-ARCmaster	Position feedback is evaluated as the difference of ARC and ARCmaster.	
Special	Special feedback source, feedback value is taken from Special position [1142] (page 58).	
Special position [1142]	Value of special position source.	0.000
Min. position setpoint [1139] ÷ Max. position setpoint [1140]		

7.5.2 V/f CONTROL

Group of parameters number [81]

Setting the dependence between the output voltage and the frequency (V/f curve) and operation modes designated for the motor V/f (scalar) control.

V/f CURVE

Group of parameters number [382]

Calculation of the output motor voltage.

MENU \ SETTINGS \ CONTROL AND REGULATION \ V/F CONTROL \ V/F CURVE

Name [ID]	Description	Def.
V/f Type [347]	V/f Curve type. Selecting the features of the V/f control method operation.	
<input type="checkbox"/> IR compensation	Turns on the stator resistance loss compensation [973] (page 59). Requires correct value of the motor parameters and the stator resistance Stator resistance [345] (page 44).	
<input type="checkbox"/> ST controller	Turns on the starting torque controller [29] (page 60) to boost starting torque.	
Starting voltage [90]	Starting voltage of the V/f curve.	0.00 %
0.00 % ÷ 25.00 %	Starting voltage affects torque and motor current in the range of overexcitation, which is bounded by parameter Frequency shift [98] (page 59). For high torque starts (high friction, inertia), it should be set higher than the default value preset by motor macro parameters. Low power motors in general need higher starting voltage than the high power motors.	
End voltage [94]	End voltage of the V/f curve.	100.0 %
5.0 % ÷ 150.0 %	End voltage is the value of V/f curve at the nominal frequency of Nom. frequency [4] (page 43). Normally set to 100%, representing a nominal motor voltage. For achieving a slight power increase, it can be set to more than 100%. Value lower than 100% causes lower motor excitation in whole speed range and is suitable for testing motor of higher power than the nominal power of the converter.	
Frequency shift [98]	Frequency shift of the V/f curve.	5.0 Hz
0.0 ÷ Nom. frequency [4]	If the motor has to be overexcited to achieve higher torque in its whole speed range, it can also be adjusted up to the value of Nom. frequency [4] (page 43), e.g. crane lifts.	
V/f exponent [91]	V/f curve exponent.	1.00
0.60 ÷ 2.00	Affects the curvature of the whole V/f curve to an exponential shape. The exponent value 1.00 represents the linear shape and the value 2.00 a quadratic process. Using the exponential V/f curve has its significance in pumps and fans, where the load torque grows with the rotation speed and field weakening of the motor is allowed at low speed to save energy.	
Exp. shift V/f [92]	V/f curve shift exponent in the range from 0 Hz to Frequency shift [98] (page 59).	1.00
0.60 ÷ 5.00	Affects the curvature of the V/f curve in the area to Frequency shift [98] (page 59). The exponent value 1.00 represents the linear shape and the value 2.00 a quadratic process. Using an exponent, it is possible to control the non-linear features of induction motor better near zero frequency.	
Excit. time [25]	Relative shortening or prolonging of the motor excitation time.	100 %
1 % ÷ 1000 %		

Compensation of IR (CIR)

Group of parameters number [973]

Parameters of the IR compensation. CIR is the adjustment of the output voltage according to the motor load to compensate the voltage drop on stator windings. The purpose of this correction to keep the flux constant and loss of torque as the load changes.

MENU \ SETTINGS \ CONTROL AND REGULATION \ V/F CONTROL \ V/F CURVE \ COMPENSATION OF IR (CIR)

Name [ID]	Description	Def.
IRC Filter [523]	Time constant of the filter applied to the output of the IR compensation function.	100 ms
1 ms ÷ 10000 ms		

Name [ID]	Description	Def.
CIR Frequency [795]	Upper limit of the output frequency, where the IR compensation is suppressed.	5.0 Hz
Frequency shift [98] ÷ Max. frequency [111]		

ST Controller (STC)

Group of parameters number [29]

Parameters which affect the Starting Torque Controller (STC). STC is used to force the current to the motor in the selected frequency range. This increases the motor torque. Motor should not be operated permanently in STC range, unless is cooled sufficiently.

MENU \ SETTINGS \ CONTROL AND REGULATION \ V/F CONTROL \ V/F CURVE \ ST CONTROLLER (STC)

Name [ID]	Description	Def.
STC Mode [1590]	Additional STC features selection.	
<input type="checkbox"/> P adaptivity	Turns on the adaptive function of P term based on stator frequency.	
<input type="checkbox"/> I adaptivity	Turns on the adaptive function of I term based on stator frequency derivation.	
<input type="checkbox"/> STC in regen. mode	Turns on the STC operation in regenerative mode of operation.	
STC Current [163]	Setpoint value of the starting torque current.	5.00 A
Magnetizing current [355] ÷ (I _{NK} × 1,75) ⁶	STC stops operating, or the current reference will not be achieved, if the value of Cos Phi [67] (page 16) is negative or falls below 0.05, or if the converters output voltage reaches the upper limit. In the frequency range where STC operates, maximum allowable current increases up to the maximum overload current of the converter. ⁶ The value depends on the inverter power line. See installation manual.	
Freq. STC [28]	Upper limit of the frequency area, where the starting torque controller (STC) is active.	5.0 Hz
0.0 ÷ Max. frequency [111]	This parameter limits (upper) the current regulation zone (starting torque). When the motor operates in this area for a long time, it is necessary to calculate with an excessive motor overheating and the possibility of the fault " E29-Motor overload (page 33)".	
STC Dynamics [26]	Setting the ST controller dynamics.	0.100 s
0.001 s ÷ 10.000 s	Current controller maintains the current on the value STC Current [163] (page 60), until the frequency exceeds the value Freq. STC [28] (page 60). This mode can be used to increase the starting torque to overcome Coulomb friction and hard starts. STC dynamics can adjust the rate of current regulation or dampen oscillations of the current at start-up.	
STC adapt. gain [1589]	P term of STC adaptation gain.	2.00
0.10 ÷ 20.00	Recommended setting is 2.0.	
Vq correction [1591]	Configuration of the damping correction to Vq based on cos(phi) derivation. By setting to 0.00 this feature is turned off.	0.00
-100.00 ÷ 100.00	Recommended value of the correction is 2.0.	

SLIP COMPENSATION

Group of parameters number [348]

Turning on and gain of the slip compensation. Slip compensation is required if greater accuracy of rotor speed is desired, regardless of load. It also contributes to an increase in torque overload power at low speeds. The value of slip can be controlled in Slip freq. [938] (page 15).

MENU \ SETTINGS \ CONTROL AND REGULATION \ V/F CONTROL \ SLIP COMPENSATION

Name [ID]	Description	Def.
Slip compensation [349]	Turning on the slip compensation in the scalar motor control. Slip compensation, using the motor mathematical model, corrects the frequency by a calculated slip so that rotor actual speed is near the speed setpoint value. The accuracy of the calculated slip is affected by the parameters Stator resistance	Turned off

Name [ID]	Description	Def.
	[345] (page 44), Magnetizing current [355] (page 44), Nom. power [357] (page 43), Nom. revolutions [356] (page 44).	
Turned off	Slip compensation is turned off.	
Turned on	Slip compensation is turned on.	
Slip restriction [193]	Turning on / off the slip restriction. Slip restriction operates similarly to torque limit or overload protection. This feature reduces the possibility of operation in the unstable part of the torque-speed curve of the motor. If the slip compensation is turned on, the desired frequency will be generated so it will not differ from the rotor frequency Freq. RT [937] (page 15) by more than the configured maximal slip Max. slip [177] (page 61).	Turned off
Turned off	Slip restriction is turned off.	
Turned on	Slip restriction is turned on.	
Slip comp. Gain [350]	Setting the gain of the slip compensation.	1.00
0.01 ÷ 10.00	If the slip correction is obviously not sufficient or too big because of inaccurate parameters, this parameter allows to tune the slip compensation gain to correct these inaccuracies.	
Max. slip [177]	Maximal slip frequency. It is used to limit the slip for the slip compensation function and the slip restriction function.	5.00 Hz
0.00 ÷ Nom. frequency [4]		
Slip filter [995]	Time constant of the slip filter on the slip model output.	100 ms
1 ms ÷ 10000 ms	It helps to adjust the slip compensation dynamics and the slip restriction. In case of slow reactions, it is necessary to increase the filter time constant and vice versa, when frequency oscillations occur, decrease the filter time constant.	

MAX. CURRENT CONTROLLER (MCC)

Group of parameters number [351]

Maximum current controller parameters (MCC), also called the Current limit.

MENU \ SETTINGS \ CONTROL AND REGULATION \ V/F CONTROL \ MAX. CURRENT CONTROLLER (MCC)

Name [ID]	Description	Def.
Max. current controller [352]	Turns on Maximum Current Controller (MCC), which restricts the output current to Max. mot. current [5] (page 75) or Max. regen. current [549] (page 75) by the correction of output frequency. It is possible to turn on MCC operation for motoric, regenerative or both modes of operation. Current limit is used to start large inertial loads or load proportional to the motor speed (pumps, fans, mixers, mills). It can also be used in applications, where motor overload occurs. If the maximum value is lower than Permanent current [24] (page 47), MCC ensures permanent operation of the converter. In the beginning of the operation or near zero frequency, output current can exceed the limit value set by Max. mot. current [5] (page 75) or Max. regen. current [549] (page 75).	Motoric
<input checked="" type="checkbox"/> Motoric	Turning on / off MCC for motoric mode of operation. Output current is restricted to Max. mot. current [5] (page 75) in motoric mode of operation.	
<input type="checkbox"/> Regenerative	Turning on / off MCC for regenerative mode of operation. Output current is restricted to Max. regen. current [549] (page 75) in regenerative mode of operation.	
<input type="checkbox"/> High dynamic	High dynamic MCC control.	
<input type="checkbox"/> Adaptive dynamic	Dynamics is adaptively adjusted according to MCC adaptivity [667] (page 62).	
<input type="checkbox"/> Auto adaptivity	Dynamics adaptivity is automatically set.	
<input type="checkbox"/> Boost I _{max} off	Turns off I _{max} boosting above the set value of parameter Max. mot. current [5] (page 75) for the frequency lower than Freq. break. MCC [1191] (page 62).	
P term of the MCC [353]	Gain value of the maximum current controller (MCC) proportional term.	0.500
0.000 ÷ 30.000	The higher the P term of MCC value, the bigger the damping and lower the current overshoot caused by load steps and speed changes. On the slow I-term of MCC, lower gain is set and on the faster term higher gain, so the MCC remains stable. When changing this	

Name [ID]	Description	Def.
	parameter, we advise consulting this step always with the VONSCH s.r.o. service.	
I term of the MCC [354]	Integration time constant value of the maximum current controller(MCC).	0.120 s
0.001 s ÷ 100.000 s	Determines the current regulation dynamics using the MCC. When changing this parameter, we always recommend consulting this step with the VONSCH s.r.o. service.	
D term of the MCC [1047]	Gain value of the maximum current controller (MCC) derivation term.	0.000
0.000 ÷ 100.000	Derivation term is disabled if the value is set to 0 s. Helps to reduce current overshoot during the step motor load change. When changing this parameter, we advise consulting this step always with the VONSCH s.r.o. service.	
MCC Volt. Gain [799]	Gain of the maximum current controller (MCC) effect on the motor voltage.	1.000
0.000 ÷ 100.000	In low frequency zones, the MCC effect on the frequency weakens and depending on the value of this parameter, reduce the motor voltage.	
Freq. break. MCC [1191]	Stator frequency limit, below which MCC reduces the effect of the frequency correction and prioritize the voltage correction.	5.0 Hz
0.0 ÷ Max. frequency [111]		
Freq. III. region [1193]	Stator frequency, above which the maximal current is decreased to prevent the operation in the unstable part of the torque-speed characteristics.	150.0 Hz
Nom. frequency [4] ÷ 500.0	Frequency range above this frequency is called region of power reduction.	
MCC adaptivity [667]	Adaptation coefficient of MCC. Value 1 represents the lowest dynamics, value 0 the highest dynamics.	0.000
0.000 ÷ 1.000		

RESONANCE DAMPING

Group of parameters number [512]

Parameters for the damping the resonance of the motor and the mechanical system.

MENU \ SETTINGS \ CONTROL AND REGULATION \ V/F CONTROL \ RESONANCE DAMPING

Name [ID]	Description	Def.
Resonance damping [513]	Turning on / off the resonant oscillations damping function during the V/f control of the motor. Resonance damping can decrease or suppress undesired motor oscillations, mainly during very low load run.	Turned off
Turned off	Resonance damping is turned off.	
Turned on	Resonance damping is turned on.	
Effect dVdc on Fs [514]	Setting the resonance damping gain of the DC voltage derivation.	0.500
-100.000 ÷ 100.000	Sets the damping rate. Oscillation can increase if this rate is too high and an irregular noise can be heard from the motor.	
Effect dwls on dFs [516]	Setting the resonance damping gain from the stator current frequency change.	0.000
-100.000 ÷ 100.000	Sets the damping rate. Oscillation can increase if this rate is too high and an irregular noise can be heard from the motor.	
Effect dls on Us [515]	Resonance damping gain from the derivative of the active and reactive component of the stator current to active and reactive voltage components.	0.500
-10.000 ÷ 10.000	Sets the damping rate. Oscillation can increase if this rate is too high and an irregular noise can be heard from the motor.	
Effect dls2 on Us2 [1592]	The weight of the reactive component of the Is2 stream on the reactive voltage component Us2.	0.000
-100.000 ÷ 100.000	The overall rate of the damping of the reactive current component is the result of multiplying Effect dls on Us [515] (page 62) and this parameter. If the values are too high, vibrations can be amplified and a noise can be heard from the motor.	
V/f Identification Rs [383]	Turning on of the automatic identification mode of the stator resistance. For V/f control mode only.	Turned off

Name [ID]	Description	Def.
Turned on	Identification of the stator resistance is turned on. At every start and satisfying the conditions of measurement (low speed) the resistance is identified and written to parameter Stator resistance [345] (page 44).	
Turned off	Stator resistance is not identified.	
Mag. current identification [384]	Turning on of the automatic magnetizing current identification of the motor. (V/f control only)	Turned off
Turned on	Magnetizing current identification during the motor operation is turned on. When the measuring conditions are satisfied (rotation speed range to F_n , idle operation), the magnetizing current is identified and its values is saved to the Magnetizing current [355] (page 44) parameter.	
Turned off	Magnetizing flux will not be identified.	

7.5.3 VECTOR CONTROL

Group of parameters number [438]

Parameters affecting the control blocks and controllers in the vector control mode (see the parameter Motor control method [451] (page 57)).

Detailed description of vector control can be found on www.vonsch.sk, in the section Support.

CURRENT CONTROLLER (CC)

Group of parameters number [446]

Current controller parameters. Output of current controllers is the voltage. For smooth operation, the precise value of the parameters Leakage inductance [440] (page 45) and Stator resistance [345] (page 44) is required.

MENU \ SETTINGS \ CONTROL AND REGULATION \ VECTOR CONTROL \ CURRENT CONTROLLER (CC)

Name [ID]	Description	Def.
CC Damping [443]	Current controller damping coefficient. Decreasing the value increases the current control loop bandwidth at the cost of a higher overshoot.	1.30
0.20 ÷ 15.00		
CC Dynamics [447]	Current controller dynamics (frequency bandwidth).	100 Hz
10 Hz ÷ 1000 Hz		
Curr. cont. decoupling [157]	Decoupling of the voltage output of the current controllers.	Turned off
Turned off Turned on		

FLUX CONTROLLER (MFC)

Group of parameters number [444]

Magnetic flux controller. Stable value of magnetic flux is required for the control. MFC is inactive in the field weakening zone.

MENU \ SETTINGS \ CONTROL AND REGULATION \ VECTOR CONTROL \ FLUX CONTROLLER (MFC)

Name [ID]	Description	Def.
MFC damping [448]	Damping coefficient of the magnetic flux controller. Decreasing the value increases the magnetic flux loop control speed at the cost of a higher overshoot.	1.00
0.00 ÷ 15.00		
MFC dynamics [456]	Magnetic flux controller dynamics - frequency bandwidth.	15 Hz
1 ÷ CC Dynamics [447]		
Magnetic Flux setpoint [452]	Value of the rotor magnetic flux. Proper value of the flux setpoint is close to Nom. voltage [59] (page 43) / Nom. frequency [4] (page 43).	1.270 Wb
0.100 Wb ÷ 5.000 Wb		

Name [ID]	Description	Def.
Flux ramp [454]	Change slope of the flux setpoint. This time represents the time,required to change the flux setpoint by 1 Wb.	0.40 s
0.10 s ÷ 50.00 s		
Flux optimization [924]	Rotor magnetic flux optimization.	
<input type="checkbox"/> Min. losses	Flux optimization is set to minimize losses. However, the overall performance and the dynamics of the motor can be decreased.	
<input type="checkbox"/> Max. torque	Flux optimization is set to maximize the torque. Motor can be excited to high flux levels.	
Opt. min. Flux [1485]	Minimum flux value during minimum losses flux optimization.	40.0 %
1.0 % ÷ 100.0 %		

SPEED CONTROLLER (SC)

Group of parameters number [445]

Speed controller. The feedback for closed vector control is taken from the parameter Speed source [1000] (page 58). Open (sensorless) vector control uses mathematical model for speed/position calculation.

MENU \ SETTINGS \ CONTROL AND REGULATION \ VECTOR CONTROL \ SPEED CONTROLLER (SC)

Name [ID]	Description	Def.
SC settings mode [1655]	Speed controller (SC) setting method.	Dynamics Hz
Dynamics Hz	Speed Controller is set using the Pole-placement method, parameters SC Damping [449] (page 64), SC Damping [449] (page 64), SC Dynamics 2 [1128] (page 64).	
P, Ti terms	Speed Controller is set using the P and Ti terms.	
Dynamics break [1129]	Frequency below which SC Dynamics 1 [457] (page 64) is used, SC Dynamics 2 [1128] (page 64) is used above this frequency. It is mainly used for increasing the dynamics of speed control at low speed. By setting this to zero value, SC Dynamics 2 [1128] (page 64) will always be used.	0.0 Hz
0.0 ÷ Max. frequency [111]		
SC Damping [449]	Speed controller damping coefficient. Decreasing the value increases the speed control loop bandwidth at the cost of a higher overshoot.	1.00
0.00 ÷ 20.00		
SC Dynamics 1 [457]	Speed controller dynamics (frequency bandwidth), used for frequency lower than Dynamics break [1129] (page 64).	1.00 Hz
0.01 ÷ CC Dynamics [447]		
SC Dynamics 2 [1128]	Speed controller dynamics (frequency bandwidth), used for frequency higher than Dynamics break [1129] (page 64).	1.00 Hz
0.01 ÷ CC Dynamics [447]		
SC P 1 [1656]	Proportional term of the speed controller, used for frequency lower than Dynamics break [1129] (page 64).	1.000
0.000 ÷ 10000.000		
SC Ti 1 [1657]	Time constant of the integration term of the speed controller, used for frequency lower than Dynamics break [1129] (page 64).	1.0000 s
0.0001 s ÷ 1000.0000 s		
SC P 2 [1659]	Proportional term of the speed controller, used for frequency higher than Dynamics break [1129] (page 64).	1.000
0.001 ÷ 10000.000		
SC Ti 2 [1658]	Time constant of the integration term of the speed controller, used for frequency higher than Dynamics break [1129] (page 64).	1.0000 s

Name [ID]	Description	Def.
0.0001 s ÷ 1000.0000 s		
Min. freq. setpoint [1231]	Minimum frequency, which the speed setpoint shall enter in static and dynamic states.	0.00 Hz
0.00 ÷ Min. frequency [110]	When reversing, the frequency setpoint directly changes from the positive value of this parameter to negative value or vice versa.	
Speed source [1531]	Speed feedforward configuration as a derivative of position setpoint. Feedforward serves to eliminate the position error in transient states.	None
None		
Position setpoint		
IRC1		
IRC2		
ARC		
IRC1-IRC2		
ARCmaster	ARCmaster, for using with RM-SERVO only.	
Speed FF corr. [1150]	Correction coefficient for speed feed-forward control.	1.00
-50.00 ÷ 50.00		

MAX. VOLTAGE CONTROLLER (MVC)

Group of parameters number [473]

Configuration of the maximum voltage controller, required for operation above the nominal frequency - field weakening area. MVC is used to adjust the actual magnetic flux of the rotor to allow motor operation at frequency higher than Nom. frequency [4] (page 43). However, the maximal achievable motor torque decreases.

MENU \ SETTINGS \ CONTROL AND REGULATION \ VECTOR CONTROL \ MAX. VOLTAGE CONTROLLER (MVC)

Name [ID]	Description	Def.
Field weakening [109]	Turning on motor field weakening operation.	Turned on
Turned on	Operating the motor over the nominal frequency is turned on and torque weakening of the motor occurs in this zone.	
Turned off	Motor will be operated at full flux only. Maximum voltage controller (MVC) is turned off.	
MVC Damping [474]	Damping coefficient of the maximum voltage controller. Decreasing the value increases the current control loop bandwidth at the cost of a higher overshoot.	1.00
0.10 ÷ 3.00		
MVC Dynamics [476]	Maximum voltage controller. dynamics - frequency bandwidth. Higher value represents faster regulation of the speed.	0.50 Hz
0.05 ÷ MVC dynamics [456]		
Voltage limit MVC [927]	Voltage limit during the field weakening.	94 %
50 % ÷ 100 %	Value is a percentage of the maximum voltage. Normally set in the range 93 - 97%. Too low values lead to power reduction. High values can cause reduced dynamics of the speed regulation.	
Voltage filter [283]	Time constant of the voltage filter during the field weakening.	0.003 s
0.000 s ÷ 3.000 s	It helps to dampen noise and oscillations caused by fluctuations of Vdc.	
Min. inductance [1189]	Minimal motor inductance. Serves as parameter for current saturation in very high speed region.	0.000000 H
0.000000 H ÷ 10.000000 H		
Max. slip [1611]	Maximal slip frequency. It is used to limit the slip for safe operation in the very high-speed and high-torque area.	0.00 Hz

Name [ID]	Description	Def.
0.00 Hz ÷ 100.00 Hz		

TORQUE CONTROL

Group of parameters number [477]

Configuration of torque control, setpoint ramps, limits and feedforward.

MENU \ SETTINGS \ CONTROL AND REGULATION \ VECTOR CONTROL \ TORQUE CONTROL

Name [ID]	Description	Def.
Ramp-up time [838]	Starting time from zero to the value of Nom. torque [1051] (page 44). Smooth torque change can reduce the jerk during the start of the drive. However, long ramp times degrade the dynamics of torque regulation.	0.010 s
0.000 s ÷ 1000.000 s		
Ramp-down time [839]	Time of the torque decline from the value of Nom. torque [1051] (page 44) to zero. Smooth torque change can reduce the jerk during the start of the drive. However, long ramp times degrade the dynamics of torque regulation.	0.010 s
0.000 s ÷ 1000.000 s		
Ramp mode [1052]	Setting the method of application of the torque ramps according to the torque polarity.	Mode 2
Mode 1	Increasing and decreasing the torque applies to its real value depending on its symbol.	
Mode 2	Increasing and decreasing the torque applies to its absolute value independently on its symbol.	
TC dynamics [1192]	Torque controller dynamics - frequency bandwidth.	0.00 Hz
0.00 ÷ CC Dynamics [447]		
Initial torque [1194]	Initial torque value, applied immediately after excitation of the motor. It is calculated as the percentage from Max. torque M [481] (page 53).	0.0 %
0.0 % ÷ 100.0 %		
Torque setpoint feedfw. [1526]	Torque setpoint is used as torque feedforward. Turning on this parameter can increase dynamic response in torque control mode.	Turned off
Turned off Turned on		
Torque FF corr. [1653]	Correction coefficient for torque feed-forward. It is calculated as the derivative of speed * moment of inertia.	0.000
-100.000 ÷ 100.000		
Torque ff. filter [1654]	Torque feedforward filter time constant.	0.0 ms
0.0 ms ÷ 1000.0 ms		

SENSORLESS VECTOR

Group of parameters number [468]

Setting the parameters of the speed observer for the sensorless vector control.

MENU \ SETTINGS \ CONTROL AND REGULATION \ VECTOR CONTROL \ SENSORLESS VECTOR

Name [ID]	Description	Def.
Adapt. damping [470]	Damping coefficient of the motor mathematical model adaptation controller.	1.0
0.1 ÷ 3.0		
Adapt. dynamics [469]	Dynamics of the motor mathematical model adaptation controller.	40 Hz
1 Hz ÷ 300 Hz		

Name [ID]	Description	Def.
Coef. avoid 0Hz [1184]	Zero speed avoiding coefficient, it is used for flux change for rapid change of stator frequency. Value 1 means no flux change.	1.00
0.50 ÷ 1.50		

POSITIONING

Group of parameters number [832]

Parameters for simple single-axis position control applications. Position control can be turned on by the parameter Control type [835] (page 58). For setting the position control, it is necessary to set up source of position setpoint Pos. source [1136] (page 53), feedback Position source [1141] (page 58), position limits Min. position setpoint [1139] (page 54) and Max. position setpoint [1140] (page 54) and position calibration Pos. calib. source [1144] (page 68).

MENU \ SETTINGS \ CONTROL AND REGULATION \ VECTOR CONTROL \ POSITIONING

Name [ID]	Description	Def.
POSC P term [1524]	P term of PI position controller.	100.00
0.00 ÷ 2000.00		
POSC. I term [1525]	I term of PI position controller.	0.000000
0.000000 ÷ 5.000000		
Position unit [1540]	Positioning unit selection. Positioning and diagnostics will then be in these units.	revolutions [rev]
revolutions [rev]	Interval of 1 revolution is <0,1).	
degrees [°]	Interval of 1 revolution is <0°,360°).	
meters [m]	Interval of 1 revolution is Wheel circumference [889] (page 46) m).	
Positioning modes [1151]		
<input type="checkbox"/> Single rev	Positioning within 1 revolution, i. there is the same position value for each physical revolution, the number of whole revolutions is ignored.	
<input type="checkbox"/> Cam	"Cam" mode does not allow some positioning options, e.g. synchronization turned off.	
<input type="checkbox"/> Enable position limits	Position setpoint is reset to the value of Calibration pos. [834] (page 68) during the calibration.	
<input type="checkbox"/> P+PI position controller	A P+PI position controller is used for positioning.	
Shift change rate [1143]	Rate of change of shift.	0.20 Hz
0.00 Hz ÷ 20.00 Hz		
Synch. dir. [1630]	Setting the positioning (synchronization) direction in unsynchronized state, when Positioning modes [1151] (page 67) is set to "Single rev".	Both directions
Both directions	Position is synchronized in both directions, to have the shortest path.	
Forward dir.	Position is synchronized only in forward direction.	
Backward dir.	Position is synchronized only in backward direction.	
Turned off	Position synchronization is switched off, after the Start command the drive continues from the last position.	
Rev. shift [1649]	Shift of position within a revolution, e.g. tool rotation. The position unit is given by the parameter Position unit [1540] (page 67).	0.0000 rev
-1.0000 rev ÷ 1.0000 rev		
Cam shift [1651]	Shift of position of the cam. The position unit is given by the parameter Position unit [1540] (page 67).	0.0000 rev
-1.0000 rev ÷ 1.0000 rev		
Cam gain [1652]	Gain of the cam.	1.00
0.00 ÷ 100.00		
Set pos. limit 1	Setting the current position as the position limit 1 for positioning within a	

Name [ID]	Description	Def.
[1660]	revolution, e.g. cam.	
Set pos. limit 2 [1661]	Setting the current position as the position limit 2 for positioning within a revolution, e.g. cam.	

MASTER ENCODER

Group of parameters number [1694]

Setting the gear ratio of the master encoder, used only when in position control of the electronic shaft type, e.g. IRC1-IRC2.

MENU \ SETTINGS \ CONTROL AND REGULATION \ VECTOR CONTROL \ POSITIONING \ MASTER ENCODER

Name [ID]	Description	Def.
Teeth at master gear input (Den.) [1624]	Number of teeth at the gearbox input (input wheel circumference) on the MASTER motor side. In older firmware versions referred to as "Den. master gear ratio".	1
1 ÷ 65535		
Teeth at master gear output (Num.) [1532]	Number of teeth at the gearbox output (output wheel circumference), MASTER technology side. In older firmware versions referred to as "Num. master gear ratio".	1
1 ÷ 65535		
Master gear ratio [1620]	The resulting gear ratio of the master encoder.	1.0000
0.0100 ÷ 100.0000		

CALIBRATION

Group of parameters number [1549]

Parameters for position calibration.

MENU \ SETTINGS \ CONTROL AND REGULATION \ VECTOR CONTROL \ CALIBRATION

Name [ID]	Description	Def.
Pos. calib. type [1236]		Calibration, shift=0
Calibration, shift=0	Rev. shift [1649] (page 67) will be resetted.	
Calibrate, keep shift	Rev. shift [1649] (page 67) is kept. Actual value of shift Rev. shift [1646] (page 17) is set to value of Rev. shift [1649] (page 67).	
Pos. calib. source [1144]	Source of the position calibration. The position will be set to the value Calibration pos. [834] (page 68).	None
	Look choises of parameter's Quick stop source. [986] (page 49)	
Calibration pos. [834]	Value, which will be stored as position value when calibration signal Pos. calib. source [1144] (page 68) is set. The position unit is given by the parameter Position unit [1540] (page 67).	0.0000 rev
Lower position limit ÷ Upper position limit	Position limits are dependent on Position unit [1540] (str. 67) a Positioning modes [1151] (str. 67).	

SPECIAL CALIBRATION

Group of parameters number [833]

Setting the special calibration source.

MENU \ SETTINGS \ CONTROL AND REGULATION \ VECTOR CONTROL \ CALIBRATION \ SPECIAL CALIBRATION

Name [ID]	Description	Def.
Calib. signal [1145]	Calibration signal. Either numerical or binary signal can be chosen.	[184] Binary inputs
Signal		
Calibration active [455]	Position calibration turn on conditions (rising edge).	
	Look choises of parameter's Binary inputs [184] (page 18)	

Name [ID]	Description	Def.
Calibration inactive [453]	Position calibration deactivation conditions.	
Look choises of parameter's Binary inputs [184] (page 18)		

OFFSETS AND SHIFTS

Group of parameters number [913]

MENU \ SETTINGS \ CONTROL AND REGULATION \ VECTOR CONTROL \ CALIBRATION \ OFFSETS AND SHIFTS

Name [ID]	Description	Def.
Pos. offset 32b high [1528]		0x00000000
0x00000000 0xFFFFFFFF	÷	
Pos. offset 32b low [911]		0x00000000
0x00000000 0xFFFFFFFF	÷	
Clear shifts and offsets [1545]		
Calibration commands [1662]		
Calibrate	Calibration, same as through Pos. calib. source [1144] (page 68). Rev. shift [1649] (page 67) will be resetted.	
Calibrate, keep shift	Calibration, however Rev. shift [1649] (page 67) stays. Actual value of shift Rev. shift [1646] (page 17) is set to value of Rev. shift [1649] (page 67).	
Reset shift ramp to 0	Resets Rev. shift [1646] (page 17) to 0.	
Reset shift ramp to Rev. shift	Resets Rev. shift [1646] (page 17) to the value of Rev. shift [1649] (page 67).	

STOPPING

Group of parameters number [1215]

Parameters for vector control STOP.

MENU \ SETTINGS \ CONTROL AND REGULATION \ VECTOR CONTROL \ STOPPING

Name [ID]	Description	Def.
Stop type [836]	Converter stop type. Ramp-down to zero speed, step to zero speed, immediate stop (zero torque and turn off).	Ramp-down
Ramp-down	Motor performs an ramp-down to zero speed.	
Step to 0	Motor stops to zero speed as fast as it can.	
Zero torque	Converter instantly turns off the motor, regardless of the rotor speed.	

IDENTIFICATION

Group of parameters number [1499]

Identification parameters of vector control.

MENU \ SETTINGS \ CONTROL AND REGULATION \ VECTOR CONTROL \ IDENTIFICATION

Name [ID]	Description	Def.
Online identification [993]	Run the online identification for selected drive parameters. Please, look to Manual for vector control setting.	
<input type="checkbox"/> Rotor resistance Rr		
<input type="checkbox"/> Stator resistance Rs		
<input type="checkbox"/> Mutual		

Name [ID]	Description	Def.
inductance Lm		
<input type="checkbox"/> Leakage inductance sigmaLs		
<input type="checkbox"/> Moment of inertia J		
<input type="checkbox"/> Saving the parameters	Turns on the saving the motor parameters - results of the online identification. If this selection is turned on, the converter will use the stored parameters for the next start. However, if the identification fails, a manual adjusting of the parameters may be necessary.	
<input type="checkbox"/> Thermal adaptation ETP	Thermal adaptation of motor parameters according to measured temperature ETP Temperature [869] (page 23) from External Thermal Protection. For proper operation of thermal adaptivity it is necessary to use a temperature sensor with linear characteristic. The temperature coefficient of resistance is set in parameter Coeff. therm. adaptation [1235] (page 46).	
Identification status [994]	Diagnostics of the motor parameter identification.	
<input type="checkbox"/> Nameplate calculation	Motor parameters were calculated from the nameplate values.	
<input type="checkbox"/> Offline identification	Motor parameters were identified by the Offline identification.	
<input type="checkbox"/> Online Rr	Rotor resistance was identified.	
<input type="checkbox"/> Online Rs	Stator resistance was identified.	
<input type="checkbox"/> Online Lm	Mutual inductance was identified.	
<input type="checkbox"/> Online Lssigma	Leakage inductance was identified.	
<input type="checkbox"/> Online J	Inertia moment was identified.	
<input type="checkbox"/> Mag. curve	Magnetization curve was identified.	
Identification fault [1093]		
<input type="checkbox"/> Rs out of range	Parameter is outside the permitted range of values. This is probably a misconfigured or disconnected motor.	
<input type="checkbox"/> Rr out of range	Parameter is outside the permitted range of values. This is probably a misconfigured or disconnected motor.	
<input type="checkbox"/> Lm out of range	Parameter is outside the permitted range of values. This is probably a misconfigured or disconnected motor.	
<input type="checkbox"/> Lss out of range	Parameter is outside the permitted range of values. This is probably a misconfigured or disconnected motor.	
<input type="checkbox"/> Tr = 0		
<input type="checkbox"/> Tr out of range	Parameter is outside the permitted range of values. This is probably a misconfigured or disconnected motor.	
<input type="checkbox"/> Timeout expired	Time reserved for identification has expired. No Start command was issued or other operational conditions were not met.	
<input type="checkbox"/> Speed not reached	Speed required for identification was not reached. Probably because of high load at the motor shaft.	
<input type="checkbox"/> High load	Identification has failed due to high motor load. Please, reduce the load.	

VDC CONTROL

Group of parameters number [1594]

Parameters for features affecting DC voltage: kinetic backup and dynamic deceleration.

MENU \ SETTINGS \ CONTROL AND REGULATION \ VECTOR CONTROL \ VDC CONTROL

Name [ID]	Description	Def.
DC voltage cont. [1593]	Behavior at very high or very low voltage. Kinetic backup tries to prevent DC undervoltage, dynamic deceleration tries to prevent DC overvoltage.	
<input type="checkbox"/> Kinetic backup <input type="checkbox"/> Dynamic deceleration		
P term inv. [1595]	Inverted value (1/P) of the DC voltage P controller.	50 V

Name [ID]	Description	Def.
1 V ÷ 150 V		
KB ref. voltage [808]	Voltage reference of the kinetic backup controller.	450.0 V
Undervoltage ¹ Overvoltage ²	¹ Refer to chapter 3.1 Undervoltage, overvoltage (str. 14) by product type. ² Refer to chapter 3.1 Undervoltage, overvoltage (str. 14) by product type.	
DD ref. voltage [1635]	Voltage reference of the dynamic deceleration controller.	1000.0 V
Undervoltage ¹ Overvoltage ²	¹ Refer to chapter 3.1 Undervoltage, overvoltage (str. 14) by product type. ² Refer to chapter 3.1 Undervoltage, overvoltage (str. 14) by product type.	

SPECIAL VECTOR PAR.

Group of parameters number [1203]

Special parameters of the vector control, used for custom applications, configured by VONSCH technicians.

MENU \ SETTINGS \ CONTROL AND REGULATION \ VECTOR CONTROL \ SPECIAL VECTOR PAR.

Name [ID]	Description	Def.
Spec. vect. choices [1642]	Special options for vector control. Used exclusively by VONSCH developers in custom applications.	
<input type="checkbox"/> no ramp slip limit	Disable behaviour that ramp is close to actual speed during saturation.	
<input type="checkbox"/> SC Kx off	Disable antiwindup for Speed Controller.	
<input type="checkbox"/> SC use Fs	Use stator frequency for speed control.	
<input type="checkbox"/> Zero torque when braked	Zero torque is applied during brake advance. In the case of lifting drives, there is a risk of the load falling over!	
<input type="checkbox"/> Max regen. current for VIM open at low F	Uses Max. regen. current [549] (page 75) instead of Max. mot. current [5] (page 75) for low stator frequency for "VIM open" mode of Motor control method [451] (page 57).	
<input type="checkbox"/> Max start. current for VIM open at low F	Uses Max. Start current [727] (page 71) instead of Max. mot. current [5] (page 75) for low stator frequency for "VIM open" mode of Motor control method [451] (page 57).	
Diff. ramp and meas. speed [828]	Difference between ramp output (speed setpoint) and the measured speed, during current or torque saturation. This option can be disabled by "no ramp slip limit" in Spec. vect. choices [1642] (page 71).	5.00 Hz
0.01 ÷ Max. frequency [111]		
Max. Start current [727]	Maximal current on the converter output near zero speed.	5.10 A
Magnetizing current [355] ÷ (I _{NK} × 1,75) ⁶	⁶ The value depends on the inverter power line. See installation manual.	

SENSORLESS VECTOR

Group of parameters number [1547]

Special setting for open (sensorless) AM control.

MENU \ SETTINGS \ CONTROL AND REGULATION \ VECTOR CONTROL \ SPECIAL VECTOR PAR. \ SENSORLESS VECTOR

Name [ID]	Description	Def.
Rs identification rate [1201]	It is possible to increase or decrease the rate of Rs identification, default = 1.	1.00
0.01 ÷ 100.00		
Mot. min. freq. Rs ident. [1206]	Minimal frequency of Rs identification in motoric mode, when satisfying all the conditions.	1.00 Hz
0.00 Hz ÷ 20.00 Hz		
Rs ident. regen. min. freq. [1208]	Minimal frequency of Rs identification in regenerative mode, when satisfying all the conditions.	1.50 Hz
0.00 Hz ÷ 20.00 Hz		
Mot. max. freq. Rs	Maximal frequency of Rs identification in motoric mode, when satisfying	3.50 Hz

Name [ID]	Description	Def.
ident. [1202]	all the conditions.	
Mot. min. freq. Rs ident. [1206] ÷ 20.00		
Regen. max. freq. Rs ident. [1251]	Maximal frequency of Rs identification in regenerative mode, when satisfying all the conditions.	5.00 Hz
Mot. min. freq. Rs ident. [1206] ÷ 20.00		
Regen. rate of Rs ident. [1207]	Rate of Rs identification in regenerative mode. It is set as relative to motoric mode of operation gain Rs identification rate [1201] (page 71). If the Rs identification in regenerative mode should be turned off, set this value to 0.00.	0.00
0.00 ÷ 10.00		
Min. torque Rs ident. [1216]	Minimal torque for Rs identification activation. It is calculated as multiple of nominal torque T _n .	0.15
0.00 ÷ 10.00		
Rr identification rate [1225]	It is possible to increase or decrease the rate of Rr identification, default = 1.	1.00
0.01 ÷ 100.00		
Min. torque Rr ident. [1228]	Minimal torque for Rr identification activation. It is calculated as multiple of nominal torque T _n .	0.55
0.00 ÷ 10.00		
Min. freq. Rr ident. [1226]	Minimal frequency of Rr identification, when satisfying all the conditions.	10.0 Hz
0.0 Hz ÷ 500.0 Hz		
Max. freq. Rr ident. [1229]	Maximal frequency of Rr identification, when satisfying all the conditions.	100.0 Hz
Min. freq. Rr ident. [1226] ÷ 500.0		
Regen. rate of Rr ident. [1227]	Rate of Rr identification in regenerative mode. It is set as relative to motoric mode of operation gain Rr identification rate [1225] (page 72). If the Rr identification in regenerative mode should be turned off, set this value to 0.00.	1.00
0.00 ÷ 10.00		
Action during instability VIM open [1250]	Action during the longer, suspicious operation in the zero frequency vicinity.	Warning and then fault
None	No action is done.	
Fault	Fault E51-Vector control instability (page 34) is generated.	
Reset observers	After Speed model and identified parameters are resetted, other control loops and observers keep operating.	
Warning	After Time to warning/reset during instability [1284] (page 72) time has passed, warning W64-Vector control instability (page 31) is generated.	
Warning and then fault	After Time to warning/reset during instability [1284] (page 72) time has passed, warning W64-Vector control instability (page 31) is generated, when the warning is set for the time of Time to error during instability [1285] (page 72), fault E51-Vector control instability (page 34) is generated.	
Time to warning/reset during instability [1284]	Time to generate the reset of control or warning W64-Vector control instability (page 31) during the longer, suspicious operation in the zero frequency vicinity.	2.0 s
0.0 s ÷ 30.0 s		
Time to error during instability [1285]	Time to generate the error E51-Vector control instability (page 34) during the longer, suspicious operation in the zero frequency vicinity for sensorless (open-loop) vector control of IM.	1.0 s
0.0 s ÷ 30.0 s		

7.5.4 FREQUENCY RAMPS

Group of parameters number [106]

Setting the times for ramp-up, ramp-down and the output frequency limits.

MENU \ SETTINGS \ CONTROL AND REGULATION \ FREQUENCY RAMPS

Name [ID]	Description	Def.
Min. frequency [110]	Minimal frequency.	0.00 Hz
0.00 ÷ Max. frequency [111]	Using the minimal frequency, it is possible to define the maximal operating speed of the drive, which is superior to all other ways of entering the speed. For example, defining the minimal speed of the pump during the pressure regulation, to ensure lubrication and cooling of bearings and sealings.	
Max. frequency [111]	Maximal frequency.	50.00 Hz
0.00 Hz ÷ 500.00 Hz	Using the maximal frequency, it is possible to define the maximal operating speed of the drive, which is superior to all other ways of entering the speed.	
Ramp type [107]	Setting the method of entering the frequency ramp parameters.	Time adherent
Time adherent	For setting the ramp speed, the ramp-up (Ramp-up 1 time [116] (page 73), Ramp-up 2 time [118] (page 73)) and ramp-down (Ramp-down 1 time [119] (page 74), Ramp-down 2 time [120] (page 74)) time parameters [s] for single sections will apply.	
Slope adherent	For setting the ramp speed, the ramp-up (Ramp-up 1 slope [124] (page 73), Ramp-up 2 slope [126] (page 73)) and ramp-down (Ramp-down 1 slope [127] (page 74), Ramp-down 2 slope [129] (page 74)) slope parameters [Hz/s] for single sections will apply.	

RAMP-UP

Group of parameters number [108]

Ramp-up settings. Restriction of motor acceleration.

MENU \ SETTINGS \ CONTROL AND REGULATION \ FREQUENCY RAMPS \ RAMP-UP

Name [ID]	Description	Def.
Ramp-up 1 time [116]	Ramp-up time for the first section of the frequency ramp.	15.00 s
0.00 s ÷ 3000.00 s	First section of the ramp-up is from 0 Hz till the Ramp-up break [117] (page 73) value.	
Ramp-up 2 time [118]	Ramp-up time for the second section of the frequency ramp.	15.00 s
0.00 s ÷ 3000.00 s	Second section of the ramp-up is from the value Ramp-up break [117] (page 73) to the parameter value Max. frequency [111] (page 73).	
Ramp-up break [117]	Ramp-up break for the first section of the frequency ramp.	50.00 Hz
0.00 ÷ Max. frequency [111]	If the ramp should be simple (single section), set this parameter to its maximum value.	
Ramp-up 1 slope [124]	Setting the ramp-up slope from zero frequency to the frequency Ramp-up break [117] (page 73).	5.000 Hz/s
0.001 Hz/s ÷ 30000.000 Hz/s	It is actually the frequency ramp acceleration in the first ramp-up section.	
Ramp-up 2 slope [126]	Setting the ramp-up slope from frequency Ramp-up break [117] (page 73) to the frequency Max. frequency [111] (page 73).	5.000 Hz/s
0.001 Hz/s ÷ 30000.000 Hz/s	It is actually the frequency ramp acceleration in the second ramp-up section.	

RAMP-DOWN

Group of parameters number [115]

Ramp-down settings. Restriction of motor deceleration.

MENU \ SETTINGS \ CONTROL AND REGULATION \ FREQUENCY RAMPS \ RAMP-DOWN

Name [ID]	Description	Def.
-----------	-------------	------

Name [ID]	Description	Def.
Ramp-down time [119] 1 0.00 s ÷ 3000.00 s	Ramp-down time for the first section of the frequency ramp. First section of the ramp-down is from the value Ramp-down break [121] (page 74) to 0 Hz.	15.00 s
Ramp-down time [120] 2 0.00 s ÷ 3000.00 s	Ramp-down time for the second section of the frequency ramp. Second section of the ramp-down is from the value Max. frequency [111] (page 73) to the parameter value Ramp-down break [121] (page 74).	15.00 s
Ramp-down break [121] 0.00 ÷ Max. frequency [111]	Ramp-down break of the frequency ramp. If the ramp should be simple (single section), set this parameter to its maximum value.	50.00 Hz
Ramp-down slope [127] 1 0.001 Hz/s ÷ 30000.000 Hz/s	Setting the ramp-down slope Ramp-down break [121] (page 74) to zero frequency. The frequency ramp deceleration in the first ramp-down section.	5.000 Hz/s
Ramp-down slope [129] 2 0.001 Hz/s ÷ 30000.000 Hz/s	Setting the ramp-down slope from frequency Max. frequency [111] (page 73) to the frequency Ramp-down break [121] (page 74). The frequency ramp deceleration in the second ramp-down section.	5.000 Hz/s
Quick reverse [807] 0.1 % ÷ 1000.0 %	Setting of the accelerated ramp-down speed against the defined ramp-down, when the frequency setpoint has the opposite symbol as the frequency ramp output (Quick reverse command). The Quick reverse function serves for better drive control on manual control, mainly in cranes and transport vehicles. For the Quick reverse function it is necessary to dissipate the kinetic energy through a braking module or flux braking.	100.0 %

S-CURVE

Group of parameters number [872]

Setting the curvature of the frequency profile to the S shape.

Serves for the drive recoil restriction and a smoother operation of the device. It is mainly used for lift, traction and crane applications.

MENU \ SETTINGS \ CONTROL AND REGULATION \ FREQUENCY RAMPS \ S-CURVE

Name [ID]	Description	Def.
S-curve mode [874]	Turning on / off and the selection of the S-curve operation mode.	
<input type="checkbox"/> Turning on the S-curve	Turning on the curvature of the ramp functions. This option is superior to other optional S-curve modes in individual quadrants of the drive.	
<input type="checkbox"/> S-curve ramp-up +	Turning on / off the S-curve for ramp-up from 0 to positive frequency.	
<input type="checkbox"/> S-curve ramp-down +	Turning on / off the S-curve for ramp-down from positive frequency to 0.	
<input type="checkbox"/> S-curve ramp-up -	Turning on / off the S-curve for ramp-up from 0 to negative frequency.	
<input type="checkbox"/> S-curve ramp-down -	Turning on / off the S-curve for ramp-down from negative frequency to 0.	
<input type="checkbox"/> S splitting	Splitting the S-curve to two separate S sections if the ramp passes 0Hz on ramp-up.	
<input type="checkbox"/> Higher insensitivity	Setting the 5x higher insensitivity to changes of the frequency setpoint against the standard insensitivity +/- 0.01 % from Fnom. Insensitivity secures the operation of S-curves even on interfered frequency setpoint signals (for example AINx).	
S-curve curvature [873] 1.0 % ÷ 100.0 %	Setting the curvature of the S-curve. It is the curvature degree of the characteristics. When curvature equals 100%, the linear section will not be present during the ramp operation. When curvature equals 50%, there will be a linear section in the middle of the S-curve with the duration of 50% of the total time. When curvature equals 0%, the whole ramp is linear.	100.0 %

Name [ID]	Description	Def.
	ATTENTION! BY 100% curvature, the time needed to reach the frequency setpoint is double the time that is needed for the linear frequency ramp.	

7.5.5 MAXIMUM CURRENT AND VOLTAGE

Group of parameters number [1211]

Values of current and output voltage restrictions.

MENU \ SETTINGS \ CONTROL AND REGULATION \ MAXIMUM CURRENT AND VOLTAGE

Name [ID]	Description	Def.
Max. mot. current [5]	Maximal current on the converter output in motoric mode of operation.	5.10 A
Magnetizing current [355] ($I_{NK} \times 1,75$) ⁶	Upper limit of the motor current in the motoric mode of operation. This current is not exceeded in vector control mode or in V/f control mode, when the maximum current controller (MCC) in motoric mode is turned on. During fast load step changes can the current on the converter output shortly exceed this limit, it depends on the load inertia, rate of load and the MCC dynamics [351] (page 61). ⁶ The value depends on the inverter power line. See installation manual.	
Max. regen. current [549]	Maximal current on the converter output in regenerative mode of operation.	5.10 A
Magnetizing current [355] ($I_{NK} \times 1,75$) ⁶	Upper limit of the motor current in the regenerative mode of operation. This current is not exceeded in vector control mode or in V/f control mode, when the maximum current controller (MCC) in regenerative mode is turned on. During fast load step changes can the current on the converter output shortly exceed this limit, it depends on the load inertia, rate of load and the MCC dynamics [351] (page 61). ⁶ The value depends on the inverter power line. See installation manual.	
Max. voltage [495]	Setting the voltage limit on the output of the frequency converter.	175.0 %
5.0 % ÷ 200.0 %	In scalar control, voltage is limited to this value. In vector control it is used as saturation of the output of current controllers. Represents a percentage of the nominal voltage of the motor Nom. voltage [59] (page 43). This means that if the DC link has sufficient voltage it is possible to supply higher voltage to the motor. If the inverter is made for 400V and motor for 230V, by setting this parameter to 174%, an increase in motor power and operation with nominal torque up to 87Hz is achieved.	
Max. duty cycle [1289]	Maximum allowed duty cycle of the converter output power elements.	107.5 %
0.0 % ÷ 130.0 %	This parameter limits the overmodulation and thus higher harmonic components of voltages and currents at the moment, when there is not not sufficient DC bus voltage. It can be combined with a higher value of the parameter Max. voltage [495] (page 75).	

7.5.6 FLYING START

Group of parameters number [373]

Parameters of the converter start mode when motor is rotating (flying start).

MENU \ SETTINGS \ CONTROL AND REGULATION \ FLYING START

Name [ID]	Description	Def.
Flying start [374]	Turning on the converter flying start to the rotating motor for control modes without speed feedback. In closed vector or V/f control (if the IRC functional feedback is working), the flying start is performed automatically, ignoring this parameter.	Turned off
Turned off	Flying start function for rotating motor is turned off. Every drive start begins from zero frequency. If START would be applied in this mode to rotating motor, fault " E11-Overcurrent (page 32)" or " E4-Overvoltage (page 32)" can occur.	
Accelerated	Direction and zero speed detection is performed on every start, which is followed by an eventual rotor speed search and flying start. This mode is suitable for drives with high moment of inertia and transportation vehicles drives.	
Normal	Rotor speed search and flying start to the rotating motor is performed on every start. This mode is suitable for drives with high moment of inertia and transportation vehicles drives.	
F. start time [375]	Frequency search period during the flying start process.	1.5 s

Name [ID]	Description	Def.
0.1 s ÷ 100.0 s	Affects the speed and the accuracy of the frequency search. If the search time is too short, it can cause the frequency to have a high deviation from the real frequency, or it will not be found at all.	
Inaf/I0 Ratio [778]	Defines the current value for the direction detection and the frequency search when phasing a spinning motor as a multiple of the magnetizing flux Magnetizing current [355] (page 44).	1.000
0.100 ÷ 3.000	Better flying-start reliability is assured at a high search current, but a bigger brake force is applied to the rotor. Correct value is found as a compromise between excessive braking and an inaccurate detection of the rotor frequency.	

7.5.7 VOLTAGE CONTROLLER (VC)

Group of parameters number [747]

Parameters of the voltage controller (VR) that includes both the KINETIC BACKUP controller and the DYNAMIC DECELERATION controller.

MENU \ SETTINGS \ CONTROL AND REGULATION \ VOLTAGE CONTROLLER (VC)

Name [ID]	Description	Def.
Kinetic backup (KB) [748]	Turning on of the kinetic backup (KB) controller, which maintains the voltage on a setpoint value KB setpoint [753] (page 76) during supply outage or voltage drop in the DC link by decreasing the output frequency, to keep the drive in operation. It is used to bypass short time power supply outage, e.g. on traction vehicles, but also on pumps and fans. Success condition is a sufficient moment of inertia of the load, whose kinetic energy is used to charge the DC link.	Turned off
Turned off	Kinetic backup is turned off.	
Turned on	Kinetic backup is turned on.	
KB setpoint [753]	Voltage setpoint of the kinetic backup controller.	450.0 V
Undervoltage ¹ ÷ Overvoltage ²	Voltage value of the DC link, which is kept when kinetic backup is active. ¹ Refer to chapter 3.1 Undervoltage, overvoltage (str. 14) by product type. ² Refer to chapter 3.1 Undervoltage, overvoltage (str. 14) by product type.	
Flux during KB [1178]	Coefficient of magnetic flux drop during kinetic backup activity.	0.60
0.30 ÷ 1.00	By decreasing the flux level it is possible to extend the time of backup during input voltage outage. Value of 1.00 means no flux decrease.	
Dynamic deceleration (DD) [749]	Turning on the dynamic deceleration (DD) controller, which maintains the voltage on a setpoint value DD setpoint [754] (page 76) during excessive voltage in the DC link by increasing the output frequency, to keep the drive in operation. It is used to brake or stop drives with high moment of inertia, where the brake resistor is not available. It can be used to support other methods of braking (BM, flux braking). It is necessary to keep in mind that this function can, when wrongly configured and with an excess of energy on the motor shaft, cause an extension of the deceleration ramp at the STOP, or an increase of frequency to maximum.	Turned off
Turned off	Dynamic deceleration is turned off.	
Turned on	Dynamic deceleration is turned on.	
Turned on - accel.	Dynamic deceleration is turned on and also the acceleration up to Fmax is allowed.	
DD setpoint [754]	Voltage setpoint of the dynamic deceleration controller.	650.0 V
Undervoltage ¹ ÷ Overvoltage ²	Voltage value of the DC link, at which the dynamic deceleration function starts, and which is kept by dynamic deceleration controller. ¹ Refer to chapter 3.1 Undervoltage, overvoltage (str. 14) by product type. ² Refer to chapter 3.1 Undervoltage, overvoltage (str. 14) by product type.	
P gain VC [751]	Gain value of the voltage controller (VC) proportional term.	0.500
0.000 ÷ 100.000	The higher the P term of VC value, the bigger the damping and lower the current regulation by load steps. For the slow I-term of VC, lower gain is set and the higher gain is set for faster I term, so the VC remains stable. When changing this parameter, we advise consulting this step always with the VONSCH s.r.o. service.	
I gain VC [752]	Gain value of the voltage controller (VC) integration term.	0.100
0.001 ÷ 100.000	Defines the regulation dynamics of the DC voltage using the VC. When changing this	

Name [ID]	Description	Def.
	parameter, we advise consulting this step always with the VONSCH s.r.o. service.	
D gain VC [750]	Gain value of the voltage controller (VC) derivative term.	0.200
0.000 ÷ 100.000	The higher the D-term of VC, the more is the voltage regulation sensitive to rapid voltage changes of the DC link. During sudden power supply outages, it is necessary to use the derivative term. Even a small derivative term can stabilize unstable controller oscillations. When changing this parameter, we advise consulting this step always with the VONSCH s.r.o. service.	
VC damping [1057]	Damping gain of voltage controller used for frequency stabilization.	0.000
0.000 ÷ 1000.000	Value of 0 means that the damping signal is not used.	
VC turn off freq. [1056]	Lower limit of the frequency band at which the voltage controller starts.	10.0 Hz
0.0 ÷ Nom. frequency [4]	Regenerating is less effective on low speeds. This parameter defines the minimal rotor frequency, under which the voltage controller is turned off.	

7.5.8 BRAKE MODULE

Group of parameters number [376]

Brake module operation settings parameters.

Brake module (BM) is used for dissipation of excess energy, which is created during the motor regenerative operation or deexcitation of single-phase or other induction loads. Prerequisite activity is the connecting of brake resistor (BR) to BR and + power terminals. Thermal contact of BR can be connected to an binary input as RESET Reset source [704] (page 49) or External fault External fault source [225] (page 114).

MENU \ SETTINGS \ CONTROL AND REGULATION \ BRAKE MODULE

Name [ID]	Description	Def.
Brake module [346]	Turning on the Brake module (BM) operation. BM serves for the energy transfer that flows back during the regenerative operation to the converter. Correct function is conditional to the braking resistor (BR) being connected to the power terminals BR and +.	Turned off
Turned off	Brake module is turned off.	
Turned on	Brake module is turned on and operates if the Braking Resistor (BR) is connected to the converter.	
Turned on when running	Brake module is turned on and operates when the converter generates voltage on its output.	
BM operating voltage [377]	Brake module operation voltage.	685.0 V
Undervoltage ¹ ÷ Overvoltage ²	When the value of this parameter is too high, the risk of the fault " E4-Overvoltage (page 32)" is high. Probability that this fault occurs in the first phase of braking is higher when a BR of less power rating is used. ¹ Refer to chapter 3.1 Undervoltage, overvoltage (str. 14) by product type. ² Refer to chapter 3.1 Undervoltage, overvoltage (str. 14) by product type.	
BM hysteresis [1645]	Hysteresis limit of brake module control.	1.13 V
0.01 V ÷ 15.00 V		
BM blocking [1204]	Setting the source of blocking the brake module operation. Thermal contact protects the brake module against damage. This parameter can select binary input BINx, where this contact is connected to, or the output of logical block.	
Look choices of parameter's Bit1 DS mask [553] (page 55)		
BM blocking fault [1205]	Evaluation of BM blocking fault.	Warning
Warning	Warning " W53-BM blocking (page 30)" is evaluated during BM blocking.	
Fault	Fault " E47-BM blocking (page 34)" is evaluated during BM blocking.	

7.5.9 FLUX BRAKING

Group of parameters number [774]

Flux Braking function settings parameters.

Flux braking is used for braking the drive when brake resistor is not connected, or to reinforce and complement other modes of braking [376] (page 77) or dynamic deceleration Dynamic deceleration (DD) [749] (page 76).

MENU \ SETTINGS \ CONTROL AND REGULATION \ FLUX BRAKING

Name [ID]	Description	Def.
Flux braking (FB) [775]	Turning on the Flux braking (FB) operation. Flux braking helps to decrease the amount of energy flowing back to the frequency converter by converting a part of the energy to motor heat. When increasing the DC-link voltage beyond the limit of Operating voltage FB [776] (page 78) then the motor excitation (V/f slope or magnetic flux) increases with an intensity proportional to the gain Flux braking gain [777] (page 78). Higher current flows in the motor. Because of this, the drive with this braking mode should be sufficiently temperature resistant or protected.	Turned off
Turned off	Flux braking is turned off.	
Turned on	Flux braking is turned on.	
Operating voltage FB [776]	Flux braking operating voltage.	580.0 V
Undervoltage ¹ ÷ Overvoltage ²	Value of the DC-link voltage, when the flux braking begins to operate. ¹ Refer to chapter 3.1 Undervoltage, overvoltage (str. 14) by product type. ² Refer to chapter 3.1 Undervoltage, overvoltage (str. 14) by product type.	
Flux braking gain [777]	Setting the gain of the flux brake.	1.00
0.00 ÷ 100.00	Too high gain can cause excessive rise of the motor current, up to fault " E11-Overcurrent (page 32)". Flux brake function is inactive when zero value is set. Correct value is selected as a compromise, so that the braking is reliable and the motor current is not unnecessarily high.	
Filter FB [1179]	Time constant of the flux brake filter on the FB output signal.	100 ms
10 ms ÷ 10000 ms	It helps to adjust the flux braking dynamics. In case of slow reactions, it is necessary to increase time constant of the filter and vice versa, when oscillations occur, decrease it.	

7.5.10 POWER RESTRICTION

Group of parameters number [811]

Converter power restriction conditions setting. Power restriction is used for keeping the drive in operation during extreme load or thermal conditions.

MENU \ SETTINGS \ CONTROL AND REGULATION \ POWER RESTRICTION

Name [ID]	Description	Def.
Power restriction (PR) [766]	Selecting the operating mode of the converter power restriction (PR). PR starts decreasing the current restriction and prevents the occurrence of faults that could stop the drive operation. If it is necessary to keep the converter operating even in adverse temperature or load conditions, it is necessary to activate the power restriction mode.	
<input type="checkbox"/> From overload	After exceeding the converter overload Thermal integral INV [31] (page 25) beyond the 90% value, power will be restricted.	
<input type="checkbox"/> From the cooler temperature	After exceeding the temperature Cooler temperature [74] (page 25) beyond the value set by the parameter Cooler temperature warning [767] (page 118), power will be restricted.	
<input type="checkbox"/> From the motor overload	After exceeding the motor overload Thermal integral MT [33] (page 25) beyond the 90% value, power will be restricted.	
<input type="checkbox"/> From external temperature	After exceeding the temperature ETP Temperature [869] (page 23) evaluated from an external temperature sensor, power will be restricted.	
<input type="checkbox"/> From the power restriction signal	Converter power restriction after exceeding the parameter value PR Signal [1088] (page 79) beyond the value PR signal limit [1089] (page 79).	
<input type="checkbox"/> From Pmax_motor	Limits engine power to parameter Max. power motor [1631] (page 79).	
<input type="checkbox"/> From Pmax_gen. by current	Limits performance at generator load on parameter Max. power gener. [1632] (page 79) by limiting the generator current.	
<input type="checkbox"/> From Pmax_gen. by speed	Limits performance at generator load on parameter Max. power gener. [1632] (page 79) by limiting the frequency.	

Name [ID]	Description	Def.
<input type="checkbox"/> From the IGBT chip temperature	After exceeding the temperature P IGBT chip temp. [673] (page 25) beyond the value set by the parameter P IGBT chip temp. warning [99] (page 118), power will be restricted.	
<input type="checkbox"/> From IGBT load	After exceeding the inverter overload IGBT load [296] (page 25) beyond the 90% value, power will be restricted.	
Max. power motor [1631]	Limitation of engine power in motor load.	1100 W
10 W ÷ 1500000 W		
Max. power gener. [1632]	Engine power limitation at generator mode.	1100 W
10 W ÷ 1500000 W		
P gain PR-Pmax [1633]	Gain value of the power restriction (PR-Pmax) controllers proportional term.	0.0400
-1000.0000 ÷ 1000.0000	PR-Pmax controller works only when using the PR source active selection "From Pmax_motor" or "From Pmax_gen. by current". If the proportional gain is negative, then regulation error is inverted.	
I gain PR-Pmax [1634]	Integration time constant value of the power restriction (PR-Pmax) controllers proportional term.	0.15 s
0.00 s ÷ 1000.00 s	PR-Pmax controller works only when using the PR source active selection "From Pmax_motor" or "From Pmax_gen. by current".	
PR Signal [1088]	Selection of the signal, according to which the power will be restricted by an active selection of the power restriction source [75] CB Power restriction (PR) [766] (page 78) - from the power restriction signal temperature	
Signal		
PR signal limit [1089]	Signal limit PR Signal [1088] (page 79), beyond which the converter restricts the power.	55.0 °C
0.0 °C ÷ 200.0 °C		
P gain PR [1090]	Gain value of the power restriction (PR) controllers proportional term.	1.0000
-1000.0000 ÷ 1000.0000	PR controller works only when using the PR source active selection from the power restriction signal. If the proportional gain is negative, then regulation error is inverted.	
I gain PR [1091]	Integration time constant value of the power restriction (PR) controllers proportional term.	1.00 s
0.00 s ÷ 1000.00 s	PR controller works only when using the PR source active selection from the power restriction signal.	
K_Fmax_Pmax_gen [1637]	Coefficient of fine-tuning the size of the speed limitation from Limitation of the generator power of the motor with the active selection "From Pmax_gen. by speed".	1.00
0.01 ÷ 10000.00		

7.6 INPUTS AND OUTPUTS

Group of parameters number [216]

Setting of the control, digital and analog inputs and outputs of converter.

7.6.1 BINARY INPUTS

Group of parameters number [143]

Binary (digital) inputs setting.

MENU \ SETTINGS \ INPUTS AND OUTPUTS \ BINARY INPUTS

Name [ID]	Description	Def.
BIN HW Type [172]	Binary inputs hardware evaluation setting. The evaluation covers all digital inputs simultaneously.	24V Level
0V Level	Individual binary inputs X1:1, X1:2, X1:3, X1:4, X1:5, X1:6 are active when 0V voltage is connected (Terminal X1:10).	

Name [ID]	Description	Def.
24V Level	Individual binary inputs X1:1, X1:2, X1:3, X1:4, X1:5, X1:6 are active when 24V voltage is connected (Terminal X1:8).	
BIN1 Filter [178]	Time constant of the binary signal filter.	10 ms
0 ms 30000 ms	Binary input is switched on when the voltage level defined by parameter BIN HW Type [172] (page 79) is present longer than the value of this parameter and is switched off when the voltage is not present longer than the value of this parameter.	
BIN1 Logic [716]	Determines the binary input evaluation mode. Binary input hardware settings need to be taken into account.	Direct
Direct	If the HW Type is set to 24V, then the BIN is active if there is 24V on the input. If the HW Type is set to 0V, then the BIN is active on 0V.	
Inverted	If the HW Type is set to 24V, then the BIN is active by 0V. If the HW Type is set to 0V, then the BIN is active by 24V.	
BIN2 Filter [179]	Time constant of the binary signal filter.	10 ms
0 ms 30000 ms	Binary input is switched on when the voltage level defined by parameter BIN HW Type [172] (page 79) is present longer than the value of this parameter and is switched off when the voltage is not present longer than the value of this parameter.	
BIN2 Logic [717]	Determines the binary input evaluation mode. Binary input hardware settings need to be taken into account.	Direct
Look choices of parameter's BIN1 Logic [716] (page 80)		
BIN3 Filter [180]	Time constant of the binary signal filter.	10 ms
0 ms 30000 ms	Binary input is switched on when the voltage level defined by parameter BIN HW Type [172] (page 79) is present longer than the value of this parameter and is switched off when the voltage is not present longer than the value of this parameter.	
BIN3 Logic [718]	Determines the binary input evaluation mode. Binary input hardware settings need to be taken into account.	Direct
Look choices of parameter's BIN1 Logic [716] (page 80)		
BIN4 Filter [181]	Time constant of the binary signal filter.	10 ms
0 ms 30000 ms	Binary input is switched on when the voltage level defined by parameter BIN HW Type [172] (page 79) is present longer than the value of this parameter and is switched off when the voltage is not present longer than the value of this parameter.	
BIN4 Logic [719]	Determines the binary input evaluation mode. Binary input hardware settings need to be taken into account.	Direct
Look choices of parameter's BIN1 Logic [716] (page 80)		
BIN5 Filter [182]	Time constant of the binary signal filter.	10 ms
0 ms 30000 ms	Binary input is switched on when the voltage level defined by parameter BIN HW Type [172] (page 79) is present longer than the value of this parameter and is switched off when the voltage is not present longer than the value of this parameter.	
BIN5 Logic [720]	Determines the binary input evaluation mode. Binary input hardware settings need to be taken into account.	Direct
Look choices of parameter's BIN1 Logic [716] (page 80)		
BIN6 Filter [183]	Time constant of the binary signal filter.	10 ms
0 ms 30000 ms	Binary input is switched on when the voltage level defined by parameter BIN HW Type [172] (page 79) is present longer than the value of this parameter and is switched off when the voltage is not present longer than the value of this parameter.	
BIN6 Logic [721]	Determines the binary input evaluation mode. Binary input hardware settings need to be taken into account.	Direct
Look choices of parameter's BIN1 Logic [716] (page 80)		

7.6.2 ANALOG INPUTS

Group of parameters number [144]

Settings of the analog inputs, which are used for input, setting or continuous measurement of signals like frequency setpoint, pressure, fluid level etc.

AIN1

Group of parameters number [147]

First analog input.

MENU \ SETTINGS \ INPUTS AND OUTPUTS \ ANALOG INPUTS \ AIN1

Name [ID]	Description	Def.
AIN1 Type [153]	Analog input type.	0-10V
0-10V	Analog input level corresponds with the voltage, which is measured between the terminals X1:11 and X1:12 in the 0 to 10V(~0 až 100%) DC range.	
2-10V	Analog input level corresponds with the voltage, which is measured between the terminals X1:11 and X1:12 in the 2 to 10V(~0 až 100%) DC range. If this voltage drops under the 2V limit, the frequency converter generates the fault " E25-Interrupted AIN1 (page 33)". Fault evaluation can be turned off using AIN Fault [837] (page 114).	
0-20mA	Analog input level corresponds with the current, which is measured between the terminals X1:11 and X1:12 in the 0 to 20mA(~0 až 100%) range.	
4-20mA	Analog input level corresponds with the current, which is measured between the terminals X1:11 and X1:12 in the 4 to 20mA(~0 až 100%) range. If this voltage drops under the 4 mA limit, the frequency converter generates the fault " E25-Interrupted AIN1 (page 33)". Fault evaluation can be turned off using AIN Fault [837] (page 114).	
AIN1 Filter [254]	Time constant of first-order filter of the analog input.	100 ms
0 ms ÷ 30000 ms		

SPECIAL SETTING AIN1

Group of parameters number [150]

Analog input mapping setting for the selected parameter. Value of this parameter will be affected by the analog input value.

MENU \ SETTINGS \ INPUTS AND OUTPUTS \ ANALOG INPUTS \ AIN1 \ SPECIAL SETTING AIN1

Name [ID]	Description	Def.
AIN1 Signal [251]	Selection of the signal that will be linearly recalculated according to the analog input.	-
Signal		
Signal (AIN1_A) [253]	Signal value for the analog input level at point A.	-
- ÷ -		
Signal (AIN1_B) [252]	Signal value for the analog input level at point B.	-
- ÷ -		
AIN1_A [949]	Analog input level at point A.	0.00 V
0.00 V ÷ 10.00 V		
AIN1_B [950]	Analog input level at point B.	10.00 V
0.00 V ÷ 10.00 V		

AIN2

Group of parameters number [149]

Second analog input.

MENU \ SETTINGS \ INPUTS AND OUTPUTS \ ANALOG INPUTS \ AIN2

Name [ID]	Description	Def.
AIN2 Type [154]	Analog input type.	0-10 V
0-10 V	Analog input value corresponds with the voltage, which is measured between the terminals X1:13 and X1:14 in the 0V to 10V DC range.	
2-10 V	Analog input value corresponds with the voltage, which is measured between the terminals X1:13 and X1:14 in the 2V to 10V DC range. If this voltage drops under the 2V limit, the frequency converter generates the fault " E26-Interrupted AIN2 (page 33)". Fault evaluation can be turned off using AIN Fault [837] (page 114).	
0-20 mA	Analog input value corresponds with the current, which is measured between the terminals X1:13 and X1:14 in the 0 to 20mA range.	
4-20 mA	Analog input value corresponds with the current, which is measured between the terminals X1:13 and X1:14 in the 4 to 20mA range. If this voltage drops under the 4 mA limit, the frequency converter generates the fault " E26-Interrupted AIN2 (page 33)". Fault evaluation can be turned off using AIN Fault [837] (page 114).	
AIN2 Filter [262]	Time constant of first-order filter of the analog input.	100 ms
0 ms ÷ 30000 ms		

SPECIAL SETTING AIN2

Group of parameters number [155]

Analog input mapping setting for the selected parameter. Value of this parameter will be affected by the analog input value.

MENU \ SETTINGS \ INPUTS AND OUTPUTS \ ANALOG INPUTS \ AIN2 \ SPECIAL SETTING AIN2

Name [ID]	Description	Def.
AIN2 Signal [259]	Selection of the signal that will be linearly recalculated according to the analog input.	
Signal		
Signal (AIN2_A) [261]	Signal value for the analog input level at point A.	-
- ÷ -		
Signal (AIN2_B) [260]	Signal value for the analog input level at point B.	-
- ÷ -		
AIN2_A [951]	Analog input level at point A.	0.00 V
0.00 V ÷ 10.00 V		
AIN2_B [952]	Analog input level at point B.	10.00 V
0.00 V ÷ 10.00 V		

AIN3

Group of parameters number [148]

Third analog input. Not available for the UNIFREM 400 M converter.

MENU \ SETTINGS \ INPUTS AND OUTPUTS \ ANALOG INPUTS \ AIN3

Name [ID]	Description	Def.
AIN3	Analog input type.	0-10 V

Name [ID]	Description	Def.
Type [268]		
0-10 V	Analog input level corresponds with the voltage, which is measured between the terminals X1:15 and X1:16 in the 0 to 10V DC range.	
2-10 V	Analog input level corresponds with the voltage, which is measured between the terminals X1:15 and X1:16 in the 2 to 10V DC range. If this voltage drops under the 2V limit, the frequency converter generates the fault " E27-Interrupted AIN3 (page 33)". Fault evaluation can be turned off using AIN Fault [837] (page 114).	
0-20 mA	Analog input level corresponds with the current, which is measured between the terminals X1:15 and X1:16 in the 0 to 20mA range.	
4-20 mA	Analog input level corresponds with the current, which is measured between the terminals X1:15 and X1:16 in the 4 to 20mA range. If this voltage drops under the 4 mA limit, the frequency converter generates the fault " E27-Interrupted AIN3 (page 33)". Fault evaluation can be turned off using AIN Fault [837] (page 114).	
AIN3 Filter [272]	Time constant of first-order filter of the analog input.	100 ms
0 ms ÷ 30000 ms		

SPECIAL SETTING AIN3

Group of parameters number [156]

Analog input mapping setting for the selected parameter. Value of this parameter will be affected by the analog input value.

MENU \ SETTINGS \ INPUTS AND OUTPUTS \ ANALOG INPUTS \ AIN3 \ SPECIAL SETTING AIN3

Name [ID]	Description	Def.
AIN3 Signal [269]	Selection of the signal that will be linearly recalculated according to the analog input.	-
Signal		
Signal (AIN3_A) [270]	Signal value for the analog input level at point A.	-
- ÷ -		
Signal (AIN3_B) [271]	Signal value for the analog input level at point B.	-
- ÷ -		
AIN3_A [953]	Analog input level at point A.	0.00 V
0.00 V ÷ 10.00 V		
AIN3_B [954]	Analog input level at point B.	10.00 V
0.00 V ÷ 10.00 V		

AIN4

Group of parameters number [152]

Fourth analog input. Not available for the UNIFREM 400 M converter.

MENU \ SETTINGS \ INPUTS AND OUTPUTS \ ANALOG INPUTS \ AIN4

Name [ID]	Description	Def.
AIN4 Type [274]	Analog input type.	0-10 V
0-10 V	Analog input value corresponds with the voltage, which is measured between the terminals X1:17 and X1:18 in the 0 to 10V DC range.	

Name [ID]	Description	Def.
2-10 V	Analog input value corresponds with the voltage, which is measured between the terminals X1:17 and X1:18 in the 2 to 10V DC range. If this voltage drops under the 2V limit, the frequency converter generates the fault " E28-Interrupted AIN4 (page 33)". Fault evaluation can be turned off using AIN Fault [837] (page 114).	
0-20 mA	Analog input value corresponds with the current, which is measured between the terminals X1:17 and X1:18 in the 0 to 20mA range.	
4-20 mA	Analog input value corresponds with the current, which is measured between the terminals X1:17 and X1:18 in the 4 to 20mA range. If this voltage drops under the 4 mA limit, the frequency converter generates the fault " E28-Interrupted AIN4 (page 33)". Fault evaluation can be turned off using AIN Fault [837] (page 114).	
AIN4 Filter [278]	Time constant of first-order filter of the analog input.	100 ms
0 ms ÷ 30000 ms		

SPECIAL SETTING AIN4

Group of parameters number [199]

Analog input mapping setting for the selected parameter. Value of this parameter will be affected by the analog input value.

MENU \ SETTINGS \ INPUTS AND OUTPUTS \ ANALOG INPUTS \ AIN4 \ SPECIAL SETTING AIN4

Name [ID]	Description	Def.
AIN4 Signal [275]	Selection of the signal that will be linearly recalculated according to the analog input.	-
Signal		
Signal (AIN4_A) [276]	Signal value for the analog input level at point A.	-
- ÷ -		
Signal (AIN4_B) [277]	Signal value for the analog input level at point B.	-
- ÷ -		
AIN4_A [955]	Analog input level at point A.	0.00 V
0.00 V ÷ 10.00 V		
AIN4_B [956]	Analog input level at point B.	10.00 V
0.00 V ÷ 10.00 V		

7.6.3 RELAY OUTPUTS

Group of parameters number [146]

Relay outputs setting, which can be used for signalization of discrete values and events of the converter, e.g. fault, run, setpoint achieved.

Relay 1

Group of parameters number [186]

Relay 1 setting. Relay is connected to the terminals: NC - X2:25, COM - X2:26, NO - X2:27 (NC - X2:24, COM - X2:25, NO - X2:26 for UNIFREM 400 M).

MENU \ SETTINGS \ INPUTS AND OUTPUTS \ RELAY OUTPUTS \ RELAY 1

Name [ID]	Description	Def.
R1 Source [697]	Relay switching function setting.	Motor operation
Motor operation	Relay will switch on when the converter is in start (running).	
Ready	Relay will switch on when the converter is READY.	

Name [ID]	Description	Def.
Fault	Relay will switch on when the fault in the converter occurs.	
Brake	Relay will switch on when the mechanical brake function is activated, please see [517] (page 108).	
F=zel	Relay will switch on after reaching the setpoint frequency.	
Special	Relay will switch on after satisfying the conditions in the submenu SPECIAL SETTING.	
R1 switch-on time [307]	The relay switch-on time delay.	0.00 s
0.00 s 3600.00 s	÷ After establishment of the switch condition, the relay will switch-on after a selected amount of time.	
R1 switch-off time [308]	The relay switch-off time delay.	0.00 s
0.00 s 3600.00 s	÷ After termination of the switch condition, the relay will switch-off after a selected amount of time.	
R1 Logic [755]	Determines the relay output evaluation mode. The condition will be evaluated first, then the switch times will be evaluated and the relay logic will be evaluated last.	Direct
Direct	If the switch conditions are met, the relay will switch on.	
Inverted	If the switch conditions are met, the relay will switch off.	

SPECIAL SETTING R1

Group of parameters number [221]

Special function setting for relay 1. R1 Source [697] (page 84) must be chosen as "Special".

MENU \ SETTINGS \ INPUTS AND OUTPUTS \ RELAY OUTPUTS \ RELAY 1 \ SPECIAL SETTING R1

Name [ID]	Description	Def.
R1 Signal [189]	Signal that is evaluated for the relay switch. Either numeric or discrete signal can be chosen.	[76] Converter state
Signal		
R1 switch-on [301]	Conditions for R1 switch-on.	Run
Look choises of parameter's Converter state [76] (page 24)		
R1 switch-off [309]	Conditions for R1 switch-off.	
Look choises of parameter's Converter state [76] (page 24)		

Relay 2

Group of parameters number [187]

Relay 2 setting. Relay is connected to the terminals: NC - X2:28, COM - X2:29, NO - X2:30 (NC - X2:21, COM - X2:22, NO - X2:23 for UNIFREM 400 M).

MENU \ SETTINGS \ INPUTS AND OUTPUTS \ RELAY OUTPUTS \ RELAY 2

Name [ID]	Description	Def.
R2 Source [698]	Relay switching function setting. Functionality is the same as RELAY 1 R1 Source [697] (page 84).	Fault
Look choises of parameter's R1 Source [697] (page 84)		
R2 switch-on time [316]	Relay switch-on time delay.	0.00 s
0.00 s 3600.00 s	÷ After establishment of the switch condition, the relay will switch-on after a selected amount of time.	
R2 switch-off time [317]	Relay switch-off time delay.	0.00 s
0.00 s 3600.00 s	÷ If the switch condition is no longer valid, the relay remains switched on for a selected amount of time.	
R2 Logic [756]	Determines the relay output evaluation mode. The condition will be evaluated first, then the switch times will be evaluated and the relay logic will be evaluated last.	Direct

Name [ID]	Description	Def.
Direct	If the switch conditions are met, the relay will switch on.	
Inverted	If the switch conditions are met, the relay will switch off.	

SPECIAL SETTING R2

Group of parameters number [223]

Special function setting for relay 2. R2 Source [698] (page 85) must be chosen as "Special".

MENU \ SETTINGS \ INPUTS AND OUTPUTS \ RELAY OUTPUTS \ RELAY 2 \ SPECIAL SETTING R2

Name [ID]	Description	Def.
R2 Signal [311]	Signal that is evaluated for the relay switch. Either numeric or discrete signal can be chosen.	[76] Converter state
Signal		
R2 switch-on [313]	Conditions for R2 switch-on.	Fault
Look choises of parameter's Converter state [76] (page 24)		
R2 switch-off [314]	Conditions for R2 switch-off.	
Look choises of parameter's Converter state [76] (page 24)		

Relay 3

Group of parameters number [188]

Relay 3 setting. Not available for the UNIFREM 400 M converter. Relay is connected to the terminals: NC - X2:31, COM - X2:32, NO - X2:33.

MENU \ SETTINGS \ INPUTS AND OUTPUTS \ RELAY OUTPUTS \ RELAY 3

Name [ID]	Description	Def.
R3 Source [699]	Relay switching function setting. Functionality is the same as RELAY 1 R1 Source [697] (page 84).	Ready
Look choises of parameter's R1 Source [697] (page 84)		
R3 switch-on time [324]	Relay switch-on time delay.	0.00 s
0.00 s 3600.00 s	÷ After establishment of the switch condition, the relay will switch-on after a selected amount of time.	
R3 switch-off time [325]	Relay switch-off time delay.	0.00 s
0.00 s 3600.00 s	÷ If the switch condition is no longer valid, the relay remains switched on for a selected amount of time.	
R3 Logic [757]	Determines the relay output evaluation mode. The condition will be evaluated first, then the switch times will be evaluated and the relay logic will be evaluated last.	Direct
Direct	If the switch conditions are met, the relay will switch on.	
Inverted	If the switch conditions are met, the relay will switch off.	

SPECIAL SETTING R3

Group of parameters number [226]

Special function setting for relay 3. R3 Source [699] (page 86) must be chosen as "Special". Not available for the UNIFREM 400 M converter.

MENU \ SETTINGS \ INPUTS AND OUTPUTS \ RELAY OUTPUTS \ RELAY 3 \ SPECIAL SETTING R3

Name [ID]	Description	Def.
R3 Signal [320]	Signal that is evaluated for the relay switch. Either numeric or discrete signal can be chosen.	[76] Converter state
Signal		
R3 switch-on [321]	Conditions for R3 switch-on.	Ready
Look choises of parameter's Converter state [76] (page 24)		

Name [ID]	Description	Def.
R3 switch-off [322]	Conditions for R3 switch-off.	
Look choises of parameter's Converter state [76] (page 24)		

7.6.4 ANALOG OUTPUTS

Group of parameters number [145]

Analog outputs settings. Analog outputs are used to transfer continuous signals and quantities of the converter to superior control and diagnostic systems such as display units, PLC or measuring instruments.

A01

Group of parameters number [370]

First analog output is connected to the terminal: Plus - X1:19, Minus - X1:20 (Plus - X1:15, Minus - X1:16 for UNIFREM 400 M).

MENU \ SETTINGS \ INPUTS AND OUTPUTS \ ANALOG OUTPUTS \ AO1

Name [ID]	Description	Def.
AO1 Type [358]	Analog output type.	0-20mA
Turned off	Analog output is turned off. The output is 0mA.	
0-20mA	Analog output operates in the 0-20mA range.	
4-20mA	Analog output operates in the 4-20mA range.	
AO1 Source [1076]	Analog output quantity selection.	Freq. INV abs.
Freq. INV abs.	The output value is taken from Freq. INV abs. [472] (page 16).	
MT Current	The output value is taken from Current MT [42] (page 16).	
Power	The output value is taken from Power [66] (page 16).	
ETP Current	The output value is taken from ETP Current [870] (page 23).	
Torque	The output value is taken from Torque [69] (page 16).	
Special	The output value is taken from Special signal AOx.	
Filter AO1 [731]	Time constant of first-order filter of the analog output.	0 ms
0 ms ÷ 30000 ms		
Signal (AO1_A) [360]	Signal value for the analog output level at point A.	0.00 Hz
0.00 ÷ Max. frequency [111]		
Signal (AO1_B) [361]	Signal value for the analog output level at point B.	50.00 Hz
0.00 ÷ Max. frequency [111]		
AO1_A [941]	Analog output level at point A.	0.00 mA
0.00 mA ÷ 20.00 mA		
AO1_B [942]	Analog output level at point B.	20.00 mA
0.00 mA ÷ 20.00 mA		
AO1 Signal [359]	Selection of special signal for the analog output.	[472] Freq. INV abs.
Signal		

A02

Group of parameters number [371]

Second analog output is connected to the terminal: Plus - X1:21, Minus - X1:22 (Plus - X1:17, Minus - X1:16 for UNIFREM 400 M).

MENU \ SETTINGS \ INPUTS AND OUTPUTS \ ANALOG OUTPUTS \ AO2

Name [ID]	Description	Def.
AO2 Type [362]	Analog output type. Configuration possibilities are the same as in AO 1 AO1 Type [358] (page 87).	0-20mA
Look choises of parameter's AO1 Type [358] (page 87)		
AO2 Source [1077]	Analog output quantity selection. Configuration possibilities are the same as in AO 1 AO1 Source [1076] (page 87).	MT Current
Look choises of parameter's AO1 Source [1076] (page 87)		
Filter AO2 [732]	Time constant of first-order filter of the analog output.	0 ms

UNIFREM v.5.20x

Name [ID]	Description	Def.
0 ms ÷ 30000 ms		
Signal (AO2_A) [366]	Signal value for the analog output level at point A.	0.00 A
0.00 ÷ I _{NK2} ⁴	⁴ The value depends on the inverter power line. See installation manual.	
Signal (AO2_B) [368]	Signal value for the analog output level at point B.	6.00 A
0.00 ÷ I _{NK2} ⁴	⁴ The value depends on the inverter power line. See installation manual.	
AO2_A [945]	Analog output level at point A.	0.00 mA
0.00 mA ÷ 20.00 mA		
AO2_B [946]	Analog output level at point B.	20.00 mA
0.00 mA ÷ 20.00 mA		
AO2 Signal [364]	Selection of the signal that will linearly recalculate the analog output.	[42] Current MT
Signal		

A03

Group of parameters number [372]

Third analog output is connected to the terminal: Plus - X1:23, Minus - X1:24. Not available for the UNIFREM 400 M converters.

MENU \ SETTINGS \ INPUTS AND OUTPUTS \ ANALOG OUTPUTS \ AO3

Name [ID]	Description	Def.
AO3 Type [363]	Analog output type. Configuration possibilities are the same as in AO 1 AO1 Type [358] (page 87). Look choises of parameter's AO1 Type [358] (page 87)	0-20mA
AO3 Source [1078]	Analog output quantity selection. Configuration possibilities are the same as in AO 1 AO1 Source [1076] (page 87). Look choises of parameter's AO1 Source [1076] (page 87)	Power
Filter AO3 [733]	Time constant of first-order filter of the analog output.	0 ms
0 ms ÷ 30000 ms		
Signal (AO3_A) [367]	Signal value for the analog output level at point A.	0.0 W
-30000000000.0 W ÷ 30000000000.0 W		
Signal (AO3_B) [369]	Signal value for the analog output level at point B.	6000.0 W
-30000000000.0 W ÷ 30000000000.0 W		
AO3_A [947]	Analog output level at point A.	0.00 mA
0.00 mA ÷ 20.00 mA		
AO3_B [948]	Analog output level at point B.	20.00 mA
0.00 mA ÷ 20.00 mA		
AO3 Signal [365]	Selection of the signal that will linearly recalculate the analog output.	[66] Power
Signal		

7.6.5 IRC

Group of parameters number [435]

Setting the IRC1 sensor parameters, which is used for exact rotor speed and position measurement. This sensor can be connected to RM-UNI_IRC1 extension module. Speed is displayed in the parameter Freq. IRC1 [434] (page 19).

MENU \ SETTINGS \ INPUTS AND OUTPUTS \ IRC

Name [ID]	Description	Def.
IRC1 pulses [436]	Number of IRC pulses per turn from the sensor nameplate.	1024
0 ÷ 40000		
IRC2 pulses [827]	Number of IRC pulses per turn from the sensor nameplate.	1024
0 ÷ 40000	For low-speed motors sensor with higher pulses per turn are recommended. For high speed motors sensors with lower pulses per revolution are recommended.	
Speed calc. period IRC [437]	Speed calculation period of IRC. Increasing the parameter values increases the speed resolution and decreases the quantization noise, however, a high value can cause a negative effect on the speed control quality.	2
1 ÷ 100		
IRC speed filter [1641]	IRC1 and IRC2 encoder speed filter.	0.0 ms
0.0 ms ÷ 50.0 ms		
IRC1 direction [825]	Polarity of the IRC speed evaluation. Direct (A-B), inverted (B-A).	Direct
Direct	Polarity of position and speed is determined by cabling of the sensor.	
Inverted	By selecting this option, polarity of position and speed can be inverted without the need for re-cabling the sensor.	

7.6.6 IRC2/ARC

Group of parameters number [826]

Setting the IRC2 or ARC position and speed measurement parameters.

MENU \ SETTINGS \ INPUTS AND OUTPUTS \ IRC2/ARC

Name [ID]	Description	Def.
IRC2/ARC type [824]	Type of connected module for measurement of second position/speed.	IRC2
IRC2	No absolute position sensor module connected.	
RM-RES	Absolute position sensor (resolver) module connected.	
RM-SERVO	RM-SERVO module for reading the absolute position over serial communication is connected.	
IRC2/ARC direction [829]	Polarity of the IRC2 / ARC speed evaluation. The equivalent of direct (A-B), inverted (B-A) for IRC2.	Direct
Direct	Polarity of position and speed is determined by cabling of the sensor.	
Inverted	By selecting this option, polarity of position and speed can be inverted without the need for re-cabling the sensor.	
ARC compensation [688]	Compensation of time delay between the receiving new sample of position from RM-SERVO and its processing.	0 µs
0 µs ÷ 800 µs		

7.7 FUNCTIONS

Group of parameters number [532]

Setting an selection of different optional functions of the UNIFREM frequency converter.

7.7.1 PLC FUNCTIONS

Group of parameters number [315]

Built-in numerical and logical blocks, replacing the need for a simple control system.

LOGICAL BLOCKS

Group of parameters number [166]

Building logical links between the signals. First two logical blocks are fast (they respond in 1ms), other logical blocks respond in 10ms.

LB Timing

Group of parameters number [1024]

LB time delay setting.

MENU \ SETTINGS \ FUNCTIONS \ PLC FUNCTIONS \ LOGICAL BLOCKS \ LB TIMING

Name [ID]	Description	Def.
On delay 1 [1025]	LB on delay time. It is necessary to select the LB in parameter LB for on delay 1 [1033] (page 90), which this time is designated for.	0.00 s
0.00 s ÷ 7200.00 s		
LB for on delay 1 [1033]	Selecting the logical blocks, which the defined on delay time On delay 1 [1025] (page 90) is applied to.	
Look choises of parameter's Logical blocks [8] (page 21)		
On delay 2 [1026]	LB on delay time. It is necessary to select the LB in parameter LB for on delay 2 [1034] (page 90), which this time is designated for.	0.00 s
0.00 s ÷ 7200.00 s		
LB for on delay 2 [1034]	Selecting the logical blocks, which the defined on delay time On delay 2 [1026] (page 90) is applied to.	
Look choises of parameter's Logical blocks [8] (page 21)		
On delay 3 [1027]	LB on delay time. It is necessary to select the LB in parameter LB for on delay 3 [1035] (page 90), which this time is designated for.	0.00 s
0.00 s ÷ 7200.00 s		
LB for on delay 3 [1035]	Selecting the logical blocks, which the defined on delay time On delay 3 [1027] (page 90) is applied to.	
Look choises of parameter's Logical blocks [8] (page 21)		
On delay 4 [1028]	LB on delay time. It is necessary to select the LB in parameter LB for on delay 4 [1036] (page 90), which this time is designated for.	0.00 s
0.00 s ÷ 7200.00 s		
LB for on delay 4 [1036]	Selecting the logical blocks, which the defined on delay time On delay 4 [1028] (page 90) is applied to.	
Look choises of parameter's Logical blocks [8] (page 21)		
Off delay 1 [1029]	LB off delay time. It is necessary to select the LB in parameter LB for off delay 1 [1037] (page 90), which this time is designated for.	0.00 s
0.00 s ÷ 7200.00 s		
LB for off delay 1 [1037]	Selecting the logical blocks, which the defined off delay time Off delay 1 [1029] (page 90) is applied to.	
Look choises of parameter's Logical blocks [8] (page 21)		
Off delay 2 [1030]	LB off delay time. It is necessary to select the LB in parameter LB for off delay 2 [1038] (page 90), which this time is designated for.	0.00 s
0.00 s ÷ 7200.00 s		
LB for off delay 2 [1038]	Selecting the logical blocks, which the defined off delay time Off delay 2 [1030] (page 90) is applied to.	
Look choises of parameter's Logical blocks [8] (page 21)		
Off delay 3 [1031]	LB off delay time. It is necessary to select the LB in parameter LB for off delay 3 [1039] (page 90), which this time is designated for.	0.00 s
0.00 s ÷ 7200.00 s		
LB for off delay 3 [1039]	Selecting the logical blocks, which the defined off delay time Off delay 3 [1031] (page 90) is applied to.	
Look choises of parameter's Logical blocks [8] (page 21)		
Off delay 4 [1032]	LB off delay time. It is necessary to select the LB in parameter LB for off delay 4 [1040] (page 90), which this time is designated for.	0.00 s
0.00 s ÷ 7200.00 s		
LB for off delay 4 [1040]	Selecting the logical blocks, which the defined off delay time Off delay 4 [1032] (page 90) is applied to.	
Look choises of parameter's Logical blocks [8] (page 21)		

LB Reset

Group of parameters number [1041]

LB reset setting. Selected LB are reseted to the default status.

MENU \ SETTINGS \ FUNCTIONS \ PLC FUNCTIONS \ LOGICAL BLOCKS \ LB RESET

Name [ID]	Description	Def.
LB Reset [1045]	Selecting the logical blocks for which the reset is applied.	
Look choises of parameter's Logical blocks [8] (page 21)		
LB Reset signal [1042]	Selecting the signal for the LB Reset. It will be processed according to the selected operation. Either numeric or discrete signal can be chosen.	-
Signal		
LB Reset active [1043]	Conditions for LB reset activation.	-
- ÷ -		
LB Reset inactive [1044]	LB reset deactivation: In case of a numeric signal if the signal value is lower than the defined level.	-
- ÷ -		

LB1 (Fast)

Group of parameters number [167]

First quick logical operation setting (1ms reaction time).

MENU \ SETTINGS \ FUNCTIONS \ PLC FUNCTIONS \ LOGICAL BLOCKS \ LB1 (FAST)

Name [ID]	Description	Def.
LB1 Operation [625]	Logical operation type that will be used for the logical block.	OR
OR	Disjunction operation. The output is active if at least one of the inputs is active.	
AND	Conjunction operation. Output is active if both inputs are active.	
XOR	Exclusive sum operation. Output is active if inputs are different (one active, the other inactive).	
RS	RS flip-flop. Output is set to inactive if the first input is active. Output is set to active if the second input is active.	
=	Operation equals. Output is active if both inputs are identical.	
>=	Operation greater or equal. Output is active if the first signal is greater than or equals the second signal.	
>	Operation greater. Output is active if the first signal is greater than the second signal.	
LB1 Level [1008]	Input and output type of the logical block.	
<input type="checkbox"/> Output negated.	Logical block output will be negated.	
<input type="checkbox"/> Input 1 negated.	1 First input signal is negated.	
<input type="checkbox"/> Input 2 negated.	2 Second input signal is negated.	
<input type="checkbox"/> Input 1 edge.	First LB input responds to the leading edge of the signal.	
<input type="checkbox"/> Input 2 edge.	Second LB input responds to the leading edge of the signal.	
<input type="checkbox"/> Input 1 nohys.	The first input signal does not use hysteresis. It only decides on the level of "switch-on".	
<input type="checkbox"/> Input 2 nohys.	The second input signal does not use hysteresis. It only decides on the level of "switch-on".	
<input type="checkbox"/> Input 1 interval	The first input LB is evaluated at intervals and not hysteresis.	
<input type="checkbox"/> Input 2 interval	The second input LB is evaluated at intervals and not hysteresis.	
LB1_1 Signal [577]	Signal selection for the 1st input of LB1. It will be processed according to the selected operation. Either numeric or discrete signal can be chosen.	-
Signal		
LB1_1 switch-on [578]	Conditions for switching on the LB1_1.	-
- ÷ -		
LB1_1 switch-off	LB1_1 switch-off: In case of a numeric signal if the signal value is lower than the-	-

Name [ID]	Description	Def.
off [579]	defined level.	
- ÷ -		
LB1_2 Signal [580]	Signal selection for the 2nd input of LB1. It will be processed according to the selected operation. Either numeric or discrete signal can be chosen.	-
Signal		
LB1_2 switch-on [581]	Conditions for switching on the LB2.	-
- ÷ -		
LB1_2 switch-off [582]	LB1_2 switch-off: In case of a numeric signal if the signal value is lower than the defined level.	-
- ÷ -		

LB2 (Fast)

Group of parameters number [168]

Second quick logical operation setting (1ms reaction time).

MENU \ SETTINGS \ FUNCTIONS \ PLC FUNCTIONS \ LOGICAL BLOCKS \ LB2 (FAST)

Name [ID]	Description	Def.
LB2 Operation [626]	Logical operation type that will be used for the logical block. Configuration possibilities are the same as in LB 1 LB1 Operation [625] (page 91).	OR
Look choises of parameter's LB1 Operation [625] (page 91)		
LB2 Level [1009]	Input and output type of the logical block. Configuration possibilities are the same as in LB 1 LB1 Level [1008] (page 91).	
Look choises of parameter's LB1 Level [1008] (page 91)		
LB2_1 Signal [583]	Signal selection for the 1st input of LB2. It will be processed according to the selected operation. Either numeric or discrete signal can be chosen.	-
Signal		
LB2_1 switch-on [584]	Conditions for switching on the LB2_1.	-
- ÷ -		
LB2_1 switch-off [585]	LB2_1 switch-off: In case of a numeric signal if the signal value is lower than the defined level.	-
- ÷ -		
LB2_2 Signal [586]	Signal selection for the 2nd input of LB2. It will be processed according to the selected operation. Either numeric or discrete signal can be chosen.	-
Signal		
LB2_2 switch-on [587]	Conditions for switching on the LB2_2.	-
- ÷ -		
LB2_2 switch-off [588]	LB2_2 switch-off: In case of a numeric signal if the signal value is lower than the defined level.	-
- ÷ -		

LB3

Group of parameters number [169]

Third logical operation setting.

MENU \ SETTINGS \ FUNCTIONS \ PLC FUNCTIONS \ LOGICAL BLOCKS \ LB3

Name [ID]	Description	Def.
LB3 Operation [627]	Logical operation type that will be used for the logical block. Configuration possibilities are the same as in LB 1 LB1 Operation [625] (page 91).	OR
Look choises of parameter's LB1 Operation [625] (page 91)		
LB3 Level [1010]	Input and output type of the logical block. Configuration possibilities are the same as in LB 1 LB1 Level [1008] (page 91).	

Name [ID]	Description	Def.
Look choises of parameter's LB1 Level [1008] (page 91)		
LB3_1 Signal [589]	Signal selection for the 1st input of LB3. It will be processed according to the selected operation. Either numeric or discrete signal can be chosen.	-
Signal		
LB3_1 switch-on [590]	Conditions for switching on the LB3_1.	-
- ÷ -		
LB3_1 switch-off [591]	LB3_1 switch-off: In case of a numeric signal if the signal value is lower than the defined level.	-
- ÷ -		
LB3_2 Signal [592]	Signal selection for the 2nd input of LB3. It will be processed according to the selected operation. Either numeric or discrete signal can be chosen.	-
Signal		
LB3_2 switch-on [593]	Conditions for switching on the LB3_2.	-
- ÷ -		
LB3_2 switch-off [594]	LB3_2 switch-off: In case of a numeric signal if the signal value is lower than the defined level.	-
- ÷ -		

LB4

Group of parameters number [170]
Fourth logical operation setting.

MENU \ SETTINGS \ FUNCTIONS \ PLC FUNCTIONS \ LOGICAL BLOCKS \ LB4

Name [ID]	Description	Def.
LB4 Operation [628]	Logical operation type that will be used for the logical block. Configuration possibilities are the same as in LB 1 LB1 Operation [625] (page 91).	OR
Look choises of parameter's LB1 Operation [625] (page 91)		
LB4 Level [1011]	Input and output type of the logical block. Configuration possibilities are the same as in LB 1 LB1 Level [1008] (page 91).	
Look choises of parameter's LB1 Level [1008] (page 91)		
LB4_1 Signal [595]	Signal selection for the 1st input of LB4. It will be processed according to the selected operation. Either numeric or discrete signal can be chosen.	-
Signal		
LB4_1 switch-on [596]	Conditions for switching on the LB4_1.	-
- ÷ -		
LB4_1 switch-off [597]	LB4_1 switch-off: In case of a numeric signal if the signal value is lower than the defined level.	-
- ÷ -		
LB4_2 Signal [598]	Signal selection for the 2nd input of LB4. It will be processed according to the selected operation. Either numeric or discrete signal can be chosen.	-
Signal		
LB4_2 switch-on [599]	Conditions for switching on the LB4_2.	-
- ÷ -		
LB4_2 switch-off [600]	LB4_2 switch-off: In case of a numeric signal if the signal value is lower than the defined level.	-
- ÷ -		

LB5

Group of parameters number [171]
Fifth logical operation setting.

MENU \ SETTINGS \ FUNCTIONS \ PLC FUNCTIONS \ LOGICAL BLOCKS \ LB5

Name [ID]	Description	Def.
LB5 Operation [629]	Logical operation type that will be used for the logical block. Configuration possibilities are the same as in LB 1 LB1 Operation [625] (page 91).	OR
Look choises of parameter's LB1 Operation [625] (page 91)		
LB5 Level [1012]	Input and output type of the logical block. Configuration possibilities are the same as in LB 1 LB1 Level [1008] (page 91).	
Look choises of parameter's LB1 Level [1008] (page 91)		
LB5_1 Signal [601]	Signal selection for the 1st input of LB5. It will be processed according to the selected operation. Either numeric or discrete signal can be chosen.	-
Signal		
LB5_1 switch-on [602]	Conditions for switching on the LB5_1.	-
- ÷ -		
LB5_1 switch-off [603]	LB5_1 switch-off: In case of a numeric signal if the signal value is lower than the defined level.	-
- ÷ -		
LB5_2 Signal [604]	Signal selection for the 2nd input of LB5. It will be processed according to the selected operation. Either numeric or discrete signal can be chosen.	-
Signal		
LB5_2 switch-on [605]	Conditions for switching on the LB5_2.	-
- ÷ -		
LB5_2 switch-off [606]	LB5_2 switch-off: In case of a numeric signal if the signal value is lower than the defined level.	-
- ÷ -		

LB6

Group of parameters number [173]
Sixth logical operation setting.

MENU \ SETTINGS \ FUNCTIONS \ PLC FUNCTIONS \ LOGICAL BLOCKS \ LB6

Name [ID]	Description	Def.
LB6 Operation [630]	Logical operation type that will be used for the logical block. Configuration possibilities are the same as in LB 1 LB1 Operation [625] (page 91).	OR
Look choises of parameter's LB1 Operation [625] (page 91)		
LB6 Level [1013]	Input and output type of the logical block. Configuration possibilities are the same as in LB 1 LB1 Level [1008] (page 91).	
Look choises of parameter's LB1 Level [1008] (page 91)		
LB6_1 Signal [607]	Signal selection for the 1st input of LB6. It will be processed according to the selected operation. Either numeric or discrete signal can be chosen.	-
Signal		
LB6_1 switch-on [608]	Conditions for switching on the LB6_1.	-
- ÷ -		
LB6_1 switch-off [609]	LB6_1 switch-off: In case of a numeric signal if the signal value is lower than the defined level.	-
- ÷ -		
LB6_2 Signal [610]	Signal selection for the 2nd input of LB6. It will be processed according to the selected operation. Either numeric or discrete signal can be chosen.	-
Signal		
LB6_2 switch-on [611]	Conditions for switching on the LB6_2.	-
- ÷ -		
LB6_2 switch-off [612]	LB6_2 switch-off: In case of a numeric signal if the signal value is lower than the defined level.	-
- ÷ -		

Name [ID]	Description	Def.
off [612]	defined level.	
- ÷ -		

LB7

Group of parameters number [174]
Seventh logical operation setting.

MENU \ SETTINGS \ FUNCTIONS \ PLC FUNCTIONS \ LOGICAL BLOCKS \ LB7

Name [ID]	Description	Def.
LB7 Operation [631]	Logical operation type that will be used for the logical block. Configuration possibilities are the same as in LB 1 LB1 Operation [625] (page 91). Look choises of parameter's LB1 Operation [625] (page 91)	OR
LB7 Level [1014]	Input and output type of the logical block. Configuration possibilities are the same as in LB 1 LB1 Level [1008] (page 91). Look choises of parameter's LB1 Level [1008] (page 91)	
LB7_1 Signal [613]	Signal selection for the 1st input of LB7. It will be processed according to the selected operation. Either numeric or discrete signal can be chosen. Signal	-
LB7_1 switch-on [614]	Conditions for switching on the LB7_1. - ÷ -	-
LB7_1 switch-off [615]	LB7_1 switch-off: In case of a numeric signal if the signal value is lower than the defined level. - ÷ -	-
LB7_2 Signal [616]	Signal selection for the 2nd input of LB7. It will be processed according to the selected operation. Either numeric or discrete signal can be chosen. Signal	-
LB7_2 switch-on [617]	Conditions for switching on the LB7_2. - ÷ -	-
LB7_2 switch-off [618]	LB7_2 switch-off: In case of a numeric signal if the signal value is lower than the defined level. - ÷ -	-

LB8

Group of parameters number [175]
Eight logical operation setting.

MENU \ SETTINGS \ FUNCTIONS \ PLC FUNCTIONS \ LOGICAL BLOCKS \ LB8

Name [ID]	Description	Def.
LB8 Operation [632]	Logical operation type that will be used for the logical block. Configuration possibilities are the same as in LB 1 LB1 Operation [625] (page 91). Look choises of parameter's LB1 Operation [625] (page 91)	OR
LB8 Level [1015]	Input and output type of the logical block. Configuration possibilities are the same as in LB 1 LB1 Level [1008] (page 91). Look choises of parameter's LB1 Level [1008] (page 91)	
LB8_1 Signal [619]	Signal selection for the 1st input of LB8. It will be processed according to the selected operation. Either numeric or discrete signal can be chosen. Signal	-
LB8_1 switch-on [620]	Conditions for switching on the LB8_1. - ÷ -	-
LB8_1 switch-off [621]	LB8_1 switching off: In case of a numeric signal if the signal value is lower than the defined level.	-

Name [ID]	Description	Def.
- ÷ -		
LB8_2 Signal [622]	Signal selection for the 2nd input of LB8. It will be processed according to the selected operation. Either numeric or discrete signal can be chosen.	-
Signal		
LB8_2 switch-on [623]	Conditions for switching on the LB8_2.	-
- ÷ -		
LB8_2 switch-off [624]	LB8_2 switch-off: In case of a numeric signal if the signal value is lower than the defined level.	-
- ÷ -		

NUMERICAL BLOCKS

Group of parameters number [176]

Creating computational links among signals. They react with a delay of 10 ms.

NB1

Group of parameters number [191]

Settings of the first numerical block.

MENU \ SETTINGS \ FUNCTIONS \ PLC FUNCTIONS \ NUMERICAL BLOCKS \ NB1

Name [ID]	Description	Def.
NB1 input 1 [633]	Selection of signal for the 1st input of NB1. This signal will be processed according the selected operation.	-
Signal		
NB1 input 2 [634]	Selection of signal for the 2nd input of NB1. This signal will be processed according the selected operation.	-
Signal		
NB1 operation [635]	Type of operation used for the numerical block.	plus
plus	NB output is calculated as the sum of input signals.	
minus	NB output is calculated as the difference of input signals.	
multiply	NB output is calculated as the product of input signals.	
minimum	NB output is the minimum of input signals.	
maximum	NB output is the maximum of input signals.	
abs	NB output is the absolute value of the first input signal.	
filter	First input signal is filtered by low pass first-order filter, time constant of this filter is given by the second input value.	
multiplexer	NB output is one of the input signals. If the control signal is inactive, value of the first input will be used. If the control signal is active, value of the second input will be used.	
integrator	NB output is the integral value of the first input signal. Second input signal is used as gain value. NB output is saturated according to Output (NBx_A) and Output (NBx_B) values.	
ramp	The NB output is changed by the rate defined by input 2, until the value of input 1 is reached. If the control signal is active, input 1 is directly copied to the output.	
plus_mod	The NB output is a modulo of the sum of the input signals and the set range at the output.	
NB1 control [1279]	This parameter serves for control of numerical block. It serves as a input selector for multiplexer operation. It serves as an enable input for other operations, the operation is performed if enabled, otherwise the previous output sample is used.	Active

UNIFREM v.5.20x

Name [ID]	Description	Def.
Look choises of parameter's Bit1 DS mask [553] (page 55)		
NB1 output [1254]	Selection of output parameter, to be written to by numerical blok, according to the linear characteristic set by points A, B.	
Signal		
NB1_A [1257]	Result of the operation of numerical block at point A.	0.000000000000
-999999984306749000.000000000000 999999984306749000.000000000000	÷	
Output (NB1_A) [1255]	The output value corresponding to NB1_A [1257] (page 97).	
- ÷ -		
NB1_B [1258]	Result of the operation of numerical block at point B.	100.000000000000
-999999984306749000.000000000000 999999984306749000.000000000000	÷	
Output (NB1_B) [1256]	The output value corresponding to NB1_B [1258] (page 97).	
- ÷ -		

NB2

Group of parameters number [300]
Settings of the second numerical block.

MENU \ SETTINGS \ FUNCTIONS \ PLC FUNCTIONS \ NUMERICAL BLOCKS \ NB2

Name [ID]	Description	Def.
NB2 input 1 [637]	Selection of signal for the 1st input of NB2. This signal will be processed according the selected operation.	
Signal		
NB2 input 2 [638]	Selection of signal for the 2nd input of NB2. This signal will be processed according the selected operation.	
Signal		
NB2 operation [639]	Type of operation used for the numerical block.	plus
Look choises of parameter's NB1 operation [635] (page 96)		
NB2 control [1280]	See NB1 control [1279] (page 96).	Active
Look choises of parameter's Bit1 DS mask [553] (page 55)		
NB2 output [1259]	Selection of output parameter, to be written to by numerical blok, according to the linear characteristic set by points A, B.	
Signal		
NB2_A [1262]	Result of the operation of numerical block at point A.	0.000000000000
-999999984306749000.000000000000 999999984306749000.000000000000	÷	
Output (NB2_A) [1260]	The output value corresponding to NB2_A [1262] (page 97).	
- ÷ -		
NB2_B [1263]	Result of the operation of numerical block at point B.	100.000000000000
-999999984306749000.000000000000 999999984306749000.000000000000	÷	
Output (NB2_B) [1261]	The output value corresponding to-	

Name [ID]	Description	Def.
	NB2_B [1263] (page 97).	
- ÷ -		

NB3

Group of parameters number [302]
Settings of the third numerical block.

MENU \ SETTINGS \ FUNCTIONS \ PLC FUNCTIONS \ NUMERICAL BLOCKS \ NB3

Name [ID]	Description	Def.
NB3 input 1 [1016]	Selection of signal for the 1st input of NB3. This signal will be processed according the selected operation.	
Signal		
NB3 input 2 [1017]	Selection of signal for the 2nd input of NB3. This signal will be processed according the selected operation.	
Signal		
NB3 operation [1018]	Type of operation used for the numerical block.	plus
Look choises of parameter's NB1 operation [635] (page 96)		
NB3 control [1281]	See NB1 control [1279] (page 96).	Active
Look choises of parameter's Bit1 DS mask [553] (page 55)		
NB3 output [1264]	Selection of output parameter, to be written to by numerical blok, according to the linear characteristic set by points A, B.	
Signal		
NB3_A [1267]	Result of the operation of numerical block at point A.	0.000000000000
-999999984306749000.000000000000 ÷ 999999984306749000.000000000000		
Output (NB3_A) [1265]	The output value corresponding to NB3_A [1267] (page 98).	-
- ÷ -		
NB3_B [1268]	Result of the operation of numerical block at point B.	100.000000000000
-999999984306749000.000000000000 ÷ 999999984306749000.000000000000		
Output (NB3_B) [1266]	The output value corresponding to NB3_B [1268] (page 98).	-
- ÷ -		

NB4

Group of parameters number [310]
Settings of the fourth numerical block.

MENU \ SETTINGS \ FUNCTIONS \ PLC FUNCTIONS \ NUMERICAL BLOCKS \ NB4

Name [ID]	Description	Def.
NB4 input 1 [1020]	Selection of signal for the 1st input of NB4. This signal will be processed according the selected operation.	
Signal		
NB4 input 2 [1021]	Selection of signal for the 2nd input of NB4. This signal will be processed according the selected operation.	

Name [ID]	Description	Def.
Signal		
NB4 operation [1022]	Type of operation used for the numerical block.	plus
Look choises of parameter's NB1 operation [635] (page 96)		
NB4 control [1282]	See NB1 control [1279] (page 96).	Active
Look choises of parameter's Bit1 DS mask [553] (page 55)		
NB4 output [1269]	Selection of output parameter, to be written to by numerical blok, according to the linear characteristic set by points A, B.	-
Signal		
NB4_A [1272]	Result of the operation of numerical block at point A.	0.000000000000
-999999984306749000.000000000000 999999984306749000.000000000000	÷	
Output (NB4_A) [1270]	The output value corresponding to NB4_A [1272] (page 99).	-
- ÷ -		
NB4_B [1273]	Result of the operation of numerical block at point B.	100.000000000000
-999999984306749000.000000000000 999999984306749000.000000000000	÷	
Output (NB4_B) [1271]	The output value corresponding to NB4_B [1273] (page 99).	-
- ÷ -		

NB5

Group of parameters number [1672]
Settings of the fifth numerical block.

MENU \ SETTINGS \ FUNCTIONS \ PLC FUNCTIONS \ NUMERICAL BLOCKS \ NB5

Name [ID]	Description	Def.
NB5 input 1 [1674]	Selection of signal for the 1st input of NB5. This signal will be processed according the selected operation.	-
Signal		
NB5 input 2 [1675]	Selection of signal for the 2nd input of NB5. This signal will be processed according the selected operation.	-
Signal		
NB5 operation [1676]	Type of operation used for the numerical block.	plus
Look choises of parameter's NB1 operation [635] (page 96)		
NB5 control [1677]	This parameter serves for control of numerical block. It serves as a input selector for multiplexer operation. It serves as an enable input for other operations, the operation is performed if enabled, otherwise the previous output sample is used.	Active
Look choises of parameter's Bit1 DS mask [553] (page 55)		
NB5 output [1678]	Selection of output parameter, to be written to by numerical blok, according to the linear characteristic set by points A, B.	-
Signal		
NB5_A [1679]	Result of the operation of numerical block at point A.	0.000000000000

UNIFREM v.5.20x

Name [ID]	Description	Def.
-999999984306749000.000000000000 999999984306749000.000000000000	÷	
Output (NB5_A) [1680]	The output value corresponding to NB5_A [1679] (page 99).	-
- ÷ -		
NB5_B [1681]	Result of the operation of numerical block at point B.	100.000000000000
-999999984306749000.000000000000 999999984306749000.000000000000	÷	
Output (NB5_B) [1682]	The output value corresponding to NB5_B [1681] (page 100).	-
- ÷ -		

NB6

Group of parameters number [1673]
Settings of the sixth numerical block.

MENU \ SETTINGS \ FUNCTIONS \ PLC FUNCTIONS \ NUMERICAL BLOCKS \ NB6

Name [ID]	Description	Def.
NB6 input 1 [1683]	Selection of signal for the 1st input of NB6. This signal will be processed according the selected operation.	-
Signal		
NB6 input 2 [1684]	Selection of signal for the 2nd input of NB6. This signal will be processed according the selected operation.	-
Signal		
NB6 operation [1685]	Type of operation used for the numerical block.	plus
Look choises of parameter's NB1 operation [635] (page 96)		
NB6 control [1686]	This parameter serves for control of numerical block. It serves as a input selector for multiplexer operation. It serves as an enable input for other operations, the operation is performed if enabled, otherwise the previous output sample is used.	Active
Look choises of parameter's Bit1 DS mask [553] (page 55)		
NB6 output [1687]	Selection of output parameter, to be written to by numerical blok, according to the linear-characteristic set by points A, B.	-
Signal		
NB6_A [1688]	Result of the operation of numerical block at point A.	0.000000000000
-999999984306749000.000000000000 999999984306749000.000000000000	÷	
Output (NB6_A) [1689]	The output value corresponding to NB6_A [1688] (page 100).	-
- ÷ -		
NB6_B [1690]	Result of the operation of numerical block at point B.	100.000000000000
-999999984306749000.000000000000 999999984306749000.000000000000	÷	
Output (NB6_B) [1691]	The output value corresponding to NB6_B [1690] (page 100).	-
- ÷ -		
Data 1 [636]	Custom parameter.	1.000000000000

Name [ID]	Description	Def.
-999999984306749000.000000000000 999999984306749000.000000000000	÷ Used to store parameters and intermediate results of numerical and logical blocks.	
Data 2 [640]	Custom parameter.	1.000000000000
-999999984306749000.000000000000 999999984306749000.000000000000	÷ Used to store parameters and intermediate results of numerical and logical blocks.	
Data 3 [1019]	Custom parameter.	1.000000000000
-999999984306749000.000000000000 999999984306749000.000000000000	÷ Used to store parameters and intermediate results of numerical and logical blocks.	
Data 4 [1023]	Custom parameter.	1.000000000000
-999999984306749000.000000000000 999999984306749000.000000000000	÷ Used to store parameters and intermediate results of numerical and logical blocks.	
Data hex 5 [334]	Custom parameter. Number is set in hexadecimal base.	0x0000
0x0000 ÷ 0xFFFFFFFF	Used to store parameters and intermediate results of numerical and logical blocks.	
Data hex 6 [467]	Custom parameter. Number is set in hexadecimal base.	0x0000
0x0000 ÷ 0xFFFFFFFF	Used to store parameters and intermediate results of numerical and logical blocks.	
Data 7 [1670]	Custom parameter.	1.000000000000
-999999984306749000.000000000000 999999984306749000.000000000000	÷ Used to store parameters and intermediate results of numerical and logical blocks.	
Data 8 [1671]	Custom parameter.	1.000000000000
-999999984306749000.000000000000 999999984306749000.000000000000	÷ Used to store parameters and intermediate results of numerical and logical blocks.	

7.7.2 LIMIT SWITCHES

Group of parameters number [875]

Limit switch setting. Setting the limit switches that are used to derive the various control commands (STOP or decelerate) after the specific events.

LS1

Group of parameters number [876]

First limit switch setting

MENU \ SETTINGS \ FUNCTIONS \ LIMIT SWITCHES \ LS1

Name [ID]	Description	Def.
LS1 Type [880]	Limit switch type setting	
<input type="checkbox"/> Slowing	After the switch-on of the LS, the converter reduces the frequency to LSx frequency.	
<input type="checkbox"/> Track + Stop	After the switch-on of the LS, motor will run the track (LSx Track) in the given direction and then stops.	
<input type="checkbox"/> Stop	After the switch-on of the LS, motor stops in the given direction.	
<input type="checkbox"/> For reverse	Limit switch responds in the reverse direction only.	
<input type="checkbox"/> Weakening	Maximum motor torque is restricted to value of LSx Torque. If the "For reverse" is selected, the negative torque is restricted, otherwise positive torque is restricted.	
<input type="checkbox"/> Force freq.	After the switch-on of the LS, the converter forces the frequency to LSx frequency.	
<input type="checkbox"/> Track + Wait	After the switch-on of the LS, motor will run the track (LSx Track) in the given direction and then waits at zero speed.	
LS1 Frequency [915]	Maximum frequency restriction value when activation the limit switch function set to the "Decelerating" type. Decelerating function will be applied only for the given rotation direction according to the limit switch type.	0.00 Hz
Min. frequency [110] ÷ Max. frequency [111]		
LS1 Torque [1180]	The value of maximum torque during the activation of Limit switch set to "Weakening". Weakening is activated for positive or negative torque,	0.0 Nm

Name [ID]	Description	Def.
	according to the "For reverse" value.	
Min. ⁸ ÷ Max. torque M [481]	⁸ Value depends on the parameter Source of the torque reverse [922] (str. 52). For the choice „According to the setpoint value“ is from -(Max. torque M [481] (str. 53)), for other choices is from Min. torque [482] (str. 53).	
LS1 Track [884]	Range track that the converter allows to pass when activating the limit switch function set to the Track + Stop type. Both parameters Gear ratio [888] (page 46) and Wheel circumference [889] (page 46) need to be set.	0.0000 m
0.0000 m ÷ 99000.0000 m		
LS1 Source [895]	Limit switch source setting	None
Look choises of parameter's Quick stop source. [986] (page 49)		
LS1 Mask [896]	The limit switch command will be active if at least one of the selected binary inputs or logical blocks will be active.	
Look choises of parameter's Bit1 DS mask [553] (page 55)		

LS2

Group of parameters number [877]
Second limit switch setting

MENU \ SETTINGS \ FUNCTIONS \ LIMIT SWITCHES \ LS2

Name [ID]	Description	Def.
LS2 Type [881]	Limit switch type setting. Configuration possibilities are the same as in LS1 LS1 Type [880] (page 101).	
Look choises of parameter's LS1 Type [880] (page 101)		
LS2 Frequency [916]	Maximum frequency restriction value when activation the limit switch function set to the "Decelerating" type. Decelerating function will be applied only for the given rotation direction according to the limit switch type.	0.00 Hz
Min. frequency [110] ÷ Max. frequency [111]		
LS2 Torque [1181]	The value of maximum torque during the activation of Limit switch set to "Weakening". Weakening is activated for positive or negative torque, according to the "For reverse" value.	0.0 Nm
Min. ⁸ ÷ Max. torque M [481]	⁸ Value depends on the parameter Source of the torque reverse [922] (str. 52). For the choice „According to the setpoint value“ is from -(Max. torque M [481] (str. 53)), for other choices is from Min. torque [482] (str. 53).	
LS2 Track [885]	Range track that the converter allows to pass when activating the limit switch function set to the Track + Stop type. Both parameters Gear ratio [888] (page 46) and Wheel circumference [889] (page 46) need to be set.	0.0000 m
0.0000 m ÷ 99000.0000 m		
LS2 Source [898]	Limit switch source setting	None
Look choises of parameter's Quick stop source. [986] (page 49)		
LS2 Mask [899]	The limit switch command will be active if at least one of the selected binary inputs or logical blocks will be active.	
Look choises of parameter's Bit1 DS mask [553] (page 55)		

LS3

Group of parameters number [878]
Third limit switch setting

MENU \ SETTINGS \ FUNCTIONS \ LIMIT SWITCHES \ LS3

Name [ID]	Description	Def.
LS3 Type [882]	Limit switch type setting. Configuration possibilities are the same as in LS1 LS1 Type [880] (page 101).	
Look choises of parameter's LS1 Type [880] (page 101)		

Name [ID]	Description	Def.
LS3 Frequency [917]	Maximum frequency restriction value when activation the limit switch function set to the "Decelerating" type. Decelerating function will be applied only for the given rotation direction according to the limit switch type.	0.00 Hz
Min. frequency [110] ÷ Max. frequency [111]		
LS3 Torque [1182]	The value of maximum torque during the activation of Limit switch set to "Weakening". Weakening is activated for positive or negative torque, according to the "For reverse" value.	0.0 Nm
Min. ⁸ ÷ Max. torque M [481]	⁸ Value depends on the parameter Source of the torque reverse [922] (str. 52). For the choice „According to the setpoint value“ is from -(Max. torque M [481]) (str. 53)), for other choices is from Min. torque [482] (str. 53).	
LS3 Track [886]	Range track that the converter allows to pass when activating the limit switch function set to the Track + Stop type. Both parameters Gear ratio [888] (page 46) and Wheel circumference [889] (page 46) need to be set.	0.0000 m
0.0000 m ÷ 99000.0000 m		
LS3 Source [901]	Limit switch source setting	None
Look choises of parameter's Quick stop source. [986] (page 49)		
LS3 Mask [902]	The limit switch command will be active if at least one of the selected binary inputs or logical blocks will be active.	
Look choises of parameter's Bit1 DS mask [553] (page 55)		

LS4

Group of parameters number [879]

Fourth limit switch setting

MENU \ SETTINGS \ FUNCTIONS \ LIMIT SWITCHES \ LS4

Name [ID]	Description	Def.
KS4 Type [883]	Limit switch type setting. Configuration possibilities are the same as in LS1 LS1 Type [880] (page 101).	
Look choises of parameter's LS1 Type [880] (page 101)		
LS4 Frequency [918]	Maximum frequency restriction value when activation the limit switch function set to the "Decelerating" type. Decelerating function will be applied only for the given rotation direction according to the limit switch type.	0.00 Hz
Min. frequency [110] ÷ Max. frequency [111]		
LS4 Torque [1183]	The value of maximum torque during the activation of Limit switch set to "Weakening". Weakening is activated for positive or negative torque, according to the "For reverse" value.	0.0 Nm
Min. ⁸ ÷ Max. torque M [481]	⁸ Value depends on the parameter Source of the torque reverse [922] (str. 52). For the choice „According to the setpoint value“ is from -(Max. torque M [481]) (str. 53)), for other choices is from Min. torque [482] (str. 53).	
LS4 Track [887]	Range track that the converter allows to pass when activating the limit switch function set to the Track + Stop type. Both parameters Gear ratio [888] (page 46) and Wheel circumference [889] (page 46) need to be set.	0.0000 m
0.0000 m ÷ 99000.0000 m		
LS4 Source [904]	Limit switch source setting	None
Look choises of parameter's Quick stop source. [986] (page 49)		
LS4 Mask [905]	The limit switch command will be active if at least one of the selected binary inputs or logical blocks will be active.	
Look choises of parameter's Bit1 DS mask [553] (page 55)		

7.7.3 PROCESS CONTROLLER

Group of parameters number [385]

General process controller is intended for additional control of the selected quantity. Controlled quantity is selected using the signal specified by PC feedback source [139] (page 104) and its setpoint by Source of PC setpoint [130] (page 104). Output PC [64] (page 22) is then used as a source of a parameter of output type SIGNAL (e.g. frequency or torque setpoint).

MENU \ SETTINGS \ FUNCTIONS \ PROCESS CONTROLLER

Name [ID]	Description	Def.
PC Mode [386]	Selection of process controller mode and physical dimension of the output.	Turned off
Turned off	Process controller is turned off.	
Pressure Pa	Controlled quantity is the pressure in Pascal [Pa].	
Pressure inverted Pa	Controlled quantity is the pressure in Pascal [Pa], error is inverted.	
Pressure bar	Controlled quantity is the pressure in bar [bar].	
Pressure inverted bar	Controlled quantity is the pressure in bar [bar], error is inverted.	
Pressure atm	Controlled quantity is the pressure in atmosphere [atm].	
Pressure inverted atm	Controlled quantity is the pressure in atmosphere [atm], error is inverted.	
Temperature	Controlled quantity is the temperature in degree Celsius [°C].	
Temperature inverted	Controlled quantity is the temperature in degree Celsius [°C], error is inverted.	
Position	Controlled quantity is the position.	
Position inverted	Controlled quantity is the position, error is inverted.	
Flow	Controlled quantity is the flow.	
Flow inverted	Controlled quantity is the flow, error is inverted.	
Relative	Controlled quantity is in relative units.	
Relative inverted	Controlled quantity is in relative units, error is inverted.	
Voltage	Controlled quantity is the voltage.	
Voltage inverted	Controlled quantity is the voltage, error is inverted.	
Current	Controlled quantity is the current.	
Current inverted	Controlled quantity is the current, error is inverted.	
Power	Controlled quantity is the power.	
Power inverted	Controlled quantity is the power, error is inverted.	
Source of PC setpoint [130]	Selecting the setpoint value of the process controller.	Value
Value	Parameter Source of PC setpoint [130] (page 104) will be used as the setpoint source.	
AIN1	Analog input AIN1 will be used as the PC Setpoint value source.	
AIN2	Analog input AIN2 will be used as the PC Setpoint value source.	
AIN3	Analog input AIN3 will be used as the PC Setpoint value source.	
AIN4	Analog input AIN4 will be used as the PC Setpoint value source.	
Up/down commands	The up/down commands will be used as the setpoint source, please see [970] (page 56).	
Special	The special setting Setpoint signal [419] (page 106) will be used as the source.	
Setpoint value [407]	Process controller setpoint value. Value applies if the parameter Source of PC setpoint [130] (page 104) is set to "Value".	0.0 %
FB lower limit [396] ÷ FB upper limit [397]		
PC feedback source [139]	Process controller feedback source setting. Feedback represents the actual value of controlled quantity. It is usually a signal from the sensor or measurement converter.	Value
Look choises of parameter's Source of PC setpoint [130] (page 104)		
Feedback [418]	Process controller feedback value. Value applies if no signal is chosen PC feedback source [139] (page 104).	0.0 %
FB lower limit [396] ÷ FB upper limit [397]		

Name [ID]	Description	Def.
FB lower limit [396] -500.0 % ÷ 500.0 %	Minimal value of the regulation (feedback) range.	0.0 %
FB upper limit [397] -500.0 % ÷ 500.0 %	Maximal value of the regulation (feedback) range.	0.0 %
Dead-zone [406] -500.0 % ÷ 500.0 %	Process controller dead-zone (insensitivity) for small changes of the error value. Setting a non-zero dead-zone can suppress the oscillations at the PC output caused by noise at the control error Error PC [410] (page 22), but can also cause steady-state error, which is proportional to the value of dead-zone.	0.0 %
Proportional term P [411] 0.00 ÷ 30.00	Proportional gain of the process controller.	1.00
Integration term I [412] 0.01 s ÷ 600.01 s	Time constant of the integration term of the process controller. Integration term is turned off, if the value is set to 0 s.	10.00 s
Derivation term D [413] 0.00 s ÷ 1.00 s	Time constant of the derivation term of process controller.	0.00 s
D term filter [17] 0.0 ms ÷ 1000.0 ms	Filter time constant of the derivation term of the process controller. Filter is bypassed, when the value is set to 0 s.	0.0 ms
Parking [414]	Parking is a function, which automatically deactivates the START, if the parking conditions Depark. hyst. [416] (page 105) and Parking time [415] (page 105) are met. If the PC operates at its low limit for the time Parking time [415] (page 105), converter blocks the START. This can occur if the controlled quantity exceeds the setpoint value and the PC output is at minimum. If the regulation error changes so it exceeds the value Depark. hyst. [416] (page 105), the START block will be undone and PC starts to regulate. This function is used to prevent unnecessary operation of the device and saving the energy when the regulation has no major impact on the controlled quantity.	Turned off
Turned off	Parking is turned off.	
Turned on	Parking is turned on.	
Depark. hyst. [416] -500.0 % ÷ 500.0 %	The value the regulation error, when parking of the converter is canceled (parking = disabling the Start block).	0.0 %
Parking time [415] 0.1 s ÷ 3200.0 s	Time that has to pass, when the parking conditions are met, to park the PC (parking = blocking the Start).	60.0 s

PC Initialization

Group of parameters number [1132]

Setting the initialization (reset) signal of the PC output and the I-term to the defined value.

MENU \ SETTINGS \ FUNCTIONS \ PROCESS CONTROLLER \ PC INITIALIZATION

Name [ID]	Description	Def.
PC Reset signal [303]	Process controller reset signal.	[547] Status word negated
Signal	After activating the process controller reset signal, the integration term and the PC output are set to value given by the parameter PC Reset value [1131] (page 106).	
PC Reset [305]	Conditions for PC reset.	Run
Look choices of parameter's Converter state [76] (page 24)		

Name [ID]	Description	Def.
PC Reset inactive [779]	Deactivation of PC reset: In case of a numeric signal if the signal value is lower than the defined level.	
Look choices of parameter's Converter state [76] (page 24)		
PC Reset value [1131]	Value that is set by the converter to the output and the PC integration term after an active PC reset.	0.0000
-1.0000 1.0000	÷	

SPECIAL SETTING PC

Group of parameters number [196]

Special setting of the process controller signals.

MENU \ SETTINGS \ FUNCTIONS \ PROCESS CONTROLLER \ SPECIAL SETTING PC

Name [ID]	Description	Def.
Setpoint signal [419]	Selection of the parameter that represents the setpoint value of the process controller. The value is applied if the parameter Source of PC setpoint [130] (page 104) is set to "Special".	-
Signal	Selected parameter is automatically recalculated to the range of regulation of the process controller.	
Feedback signal [408]	Selection of the parameter that represents the feedback value of the process controller.	-
Signal	Selected parameter is automatically recalculated to the given range.	

7.7.4 OPTIMIZATION

Group of parameters number [65]

Setting the parameters for the optimization block that is used to search for the extremum of any signal using the change of a selected setpoint signal, which are connected to optimization output OPT Output [423] (page 22).

Optimization searches for an output value, at which it reaches the criteria of the selected signal. If the measuring conditions Opt. meas. signal [279] (page 108) and the operation condition Opt. reset signal [263] (page 108) during the optimization are met, new output samples are calculated in defined intervals Optimization step [742] (page 22). The found global extremum is saved to the memory.

START. POINT OPT

Group of parameters number [711]

Defines the initial conditions (starting point) of the optimization, when the scanning is turned off.

MENU \ SETTINGS \ FUNCTIONS \ OPTIMIZATION \ START. POINT OPT

Name [ID]	Description	Def.
Start. Point OPT [710]	Defines the starting value of the optimization output, when the scanning is turned off.	0.5000
0.0000 1.0000	÷ If the OPTSP source Start. point source [712] (page 106) is not selected, this fixed value will be used.	
Start. point source [712]	Selection of a signal that can be used as an optimization starting point, when the starting point storing condition is met.	-
Signal		
Start. point condition [713]	Signal that is evaluated, if a starting point from the selected signal should be set or not.	[709] OPT State
Signal	For example, parameter Status word negated [547] (page 24) is selected and in OPTSP active [714] (page 106) "Run" is selected, the starting value from Start. point source [712] (page 106) will be stored, when the converter is not in START mode. When in START, the last saved starting value is kept.	
OPTSP active [714]	Conditions for activation of starting point of optimization.	Measuring
Look choices of parameter's OPT State [709] (page 22)		

Name [ID]	Description	Def.
OPTSP inactive [715]	OPTSP inactive: In case of a numeric signal if the signal value is lower than the defined level.	
Look choises of parameter's OPT State [709] (page 22)		
Opt. signal [80]	Selection of a parameter, whose value should be optimized according to the criteria Opt. criteria [208] (page 107).	-
Signal	Most often, the optimization signal is selected as Produced or Consumed converter load (MPPT algorithm - maximum power point tracking). Optimized signal can be externally supplied via the analog inputs or derived from any other diagnostic quantity of the frequency converter.	
Opt. criteria [208]	Setting the optimization criteria. For example: on the load that consumes energy the minimum power criteria is selected; on the generators maximum or power factor of the produced power.	Signal min.
Signal min.	Optimization to the minimal value of a selected signal Opt. signal [80] (page 107).	
Signal max.	Optimization to the maximum value of a selected signal Opt. signal [80] (page 107).	
delta signal [255]	Difference between the found global extremum and the optimized quantity, when the optimization is restarted.	-
- ÷ -	Global extremum can be overwritten with a new value after the initial scan, if a new value is found that matches the optimization criteria better. If the algorithm moves away from the found global extremum more that it is set in this parameter, an optimization restart will be generated, or eventually a new scan.	
Opt. period [13]	Minimum time between two optimization steps.	2.0 s
0.1 s 3000.0 s	Time needed to fulfil the measurement condition is added to this time, the condition can be ramp settling or any other event selected by the parameter Opt. meas. signal [279] (page 108).	
Scanning [420]	Full output range scan mode. After START command or optimization reset, converter scans the full range of output OPT Output [423] (page 22) in the direction set by Start. direction [426] (page 107) in order to find new global extremum. Scanning is needed in systems where there are several local extremes and the highest one has to be found. Scan is a gradual search of the whole output range and finding the area of the global extremum. Scan step is 5% of the output signal.	Turned off
Turned off	Scanning is turned off.	
Turned on	Scanning is turned on.	
Step mode [425]	Setting the mode of optimization step calculation during the fine tuning. After starting the converter and scanning the fine optimization starts, slowly changes the output OPT Output [423] (page 22) by small fluctuations of preset step Optimization step [742] (page 22) to maintain the global extremum. Method of calculating the optimization step during the soft adjustment of the extremum.	Fixed
Fixed	Search with a constant output signal step, which is set by the parameter Min. step [427] (page 107).	
Variable	Search with a variable output signal step that is increased proportionally to the derivation of the optimized signal from the value Min. step [427] (page 107) to 5% of the output range and proportionally to the gain Adapt. step gain [743] (page 107).	
Adapt. step gain [743]	Gain of the optimization adaptivity step algorithm from the optimized signal derivative value.	0.800
0.001 100.000	Only applies to the variable optimization step in Step mode [425] (page 107).	
Min. step [427]	Minimal optimization step.	0.001
0.001 ÷ 0.050	Optimization step is the difference between two consecutive optimization output samples.	
Start. direction [426]	Direction of the first search. Depending on the technology and specific deployment, is is suitable to search from up to bottom or vice versa. Initial direction is also applied during the Scan process, if turned on.	From minimum
From	Optimization begins from the minimal output value.	

Name [ID]	Description	Def.
minimum		
From maximum	Optimization begins from the maximal output value.	
Opt. reset signal [263]	Signal defining the condition of optimization reset.	-
Signal	This signal is used as an optimization operation condition. Is usually set as a special combination of bits (flags) of the status or control word.	
Opt. reset [273]	Conditions for optimization Reset.	-
- ÷ -		
Opt. reset inactive [530]	Optimization reset deactivation: In case of a numeric signal if the signal value is lower than the defined level.	-
- ÷ -		
Opt. meas. signal [279]	Selection of a signal that is used to allow the measurement and the next optimization step.	-
Signal	Allows to set the conditions, under which the Optimization signal (Opt. signal [80] (page 107)) is stable and not burdened with different errors.	
Opt. meas. active [160]	Measurement of the next optimization step occurs after satisfying the selected condition.	-
- ÷ -		
Opt. meas. inactive [531]	Optimization measurement deactivation: In case of a numeric signal if the signal value is lower than the defined level.	-
- ÷ -		

7.7.5 MECHANICAL BRAKE

Group of parameters number [517]

Parameters for activation and operation conditions of motor mechanical brake.

MENU \ SETTINGS \ FUNCTIONS \ MECHANICAL BRAKE

Name [ID]	Description	Def.
Mechanical brake [518]	Turning on the control of the motor mechanical brake. It may have an influence on the frequency setpoint value and on command generation for the brake control Converter state [76] (page 24), bit "Mech. brake". For correct operation of the mechanical brake, it is necessary to choose the "Brake" in relay settings.	Turned off
Turned off	Mechanical brake control is turned off.	
Standard	Mechanical brake control is turned on.	
Lift	Control of the mechanical brake for lift drives is turned on.	
Brake delay [519]	Delay for the RELAY Brake switch command after the START command.	0.01 s
0.00 s ÷ 100.00 s	From experience, it is set to 0s, because the brake itself and its contactor have their delays.	
Brake reaction [520]	Brake reaction time after the RELAY switch.	0.20 s
0.00 s ÷ 100.00 s	Equals the brake reaction time from the control relay switch to the actual mechanical release. If this time is set to a shorter than the real time, torque current saturation can occur during the start and after the brake release, recoils and mechanical bumps to the system can occur.	
Brake advance [521]	Advance time of the RELAY brake switch-off after reaching the frequency Brake frequency [522] (page 108) in STOP before turning the motor off.	0.20 s
0.00 s ÷ 100.00 s	By setting this parameter, it is possible to eliminate the time until the mechanical brake safely stops the drive to prevent unwanted rotation of the shaft during the drive stop.	
Brake frequency [522]	Frequency, below which the brake is active.	2.0 Hz
0.0 ÷ Nom. frequency [4]	Helps to achieve enough starting torque during the brake release, mainly in the V/f control. In a closed operation mode and a vector operating mode, it is recommended to set it to 0.0Hz.	

7.7.6 LIFTING FUNCTIONS

Group of parameters number [1067]

Setting the parameters that are used mostly on lifting applications.

MENU \ SETTINGS \ FUNCTIONS \ LIFTING FUNCTIONS

Name [ID]	Description	Def.
Load. signal [843]	Selection of the parameter that will be used as a calculation source for the load Load [854] (page 22) quantity value.	[42] Current MT
Signal	In most cases, the signal to calculate the quantity Load [854] (page 22) and to evaluate the OPS system conditions are Torque, Current or Motor power, but there is also a method of connecting an external pressure or haul sensor as an overload signal (e.g. crane lift drives).	
100% Load [844]	Value of the selected load signal Load. signal [843] (page 109) that equals 100% of the load.	0.00 A
0.00 Ink ² ⁴	This parameter is used to recalculate the Load [854] (page 22) quantity from physical to p.u. (per unit). ⁴ The value depends on the inverter power line. See installation manual.	
Load filter [851]	First order filter that is used for noise or short peaks suppression of the selected load signal Load. signal [843] (page 109).	0.01 s
0.01 s ÷ 320.00 s		

OPS

Group of parameters number [840]

Electronic Overload Protection System. Setting the parameters of the OPS limit switch that is used to block the START command for the forward direction (during lift-up).

MENU \ SETTINGS \ FUNCTIONS \ LIFTING FUNCTIONS \ OPS

Name [ID]	Description	Def.
OPS on/off [841]	Turning on / off the electronic OPS switch. OPS deactivates START in positive direction when the drive load rate exceeds the defined criteria. It also deactivates START when there are a lot of short commands from the operator, which could bypass the time filters of the defined deactivation criteria.	Turned off
Turned off	OPS limit switch is turned off.	
Turned on	OPS limit switch is turned on.	
OPS mode. [842]	Turning on/off the overload protection switch modes.	Slow abseil Test short commands
<input type="checkbox"/> Autodetect limits	Overload limits detection mode. Overload switch effect will be blocked at the Start command and the frequency setpoint. Converter evaluates the drive load and sets the overload limits for the dynamic and static mode according to the actual values of the quantity Load [854] (page 22). It is necessary for the drive to operate with autodetection at a maximal allowed operation load.	
<input type="checkbox"/> Only static mode	Turning off the overload test in dynamic states of the drive (start). Dynamic limit and the filter are not applied and the overloader takes up only at constant speed.	
<input type="checkbox"/> Does not generate STOP	Turning off the blocking of START in a positive direction when evaluating the drive overload. Only the bit "Overload" of the status word OPS status [856] (page 23) is switched.	
<input checked="" type="checkbox"/> Slow abseil	Turning on the of weight abseil deceleration to 20% of the frequency setpoint after an overload.	
<input checked="" type="checkbox"/> Test short commands	Starting the testing of forbidden control commands. They are short commands for the drive start and operation that can deceive the overloader function and lift an excessive weight to a forbidden height. If 5 commands are created in a short period of time, the OPS will switch whether the limits are overstepped or not.	
Time after the start [852]	Insensitivity period of the OPS after the drive start.	0.01 s

Name [ID]	Description	Def.
0.01 s ÷ 320.00 s	It is used to suppress undesired load overshoots created by the the motor excitation and to suppress the parking brake effect.	
Dynamic overload [845]	Drive overload limit in dynamic states (when accelerating in a positive direction).	150.0 %
0.0 % ÷ 1000.0 %	Overload occurs if the quantity Load [854] (page 22) exceeds this value for a period longer than Dynamic overload period [848] (page 110). This parameter is in the autodetection mode of the limits set automatically by the converter.	
Dynamic overload period [848]	Period during which the quantity Load [854] (page 22) has to be higher than the dynamic overload limit, so the overload switch will switch.	0.10 s
0.01 s ÷ 320.00 s		
Static overload [846]	Drive overload limit in static states (at a constant speed in a positive direction).	100.0 %
0.0 % ÷ 1000.0 %	Overload occurs if the quantity Load [854] (page 22) exceeds this value for a period longer than Static overload period [849] (page 110). This parameter is in the limit autodetection mode set automatically by the converter.	
Static overload period [849]	Period during which the quantity Load [854] (page 22) value has to be higher than the static overload limit, so the OPS switch will switch on.	1.00 s
0.01 s ÷ 320.00 s		
Overload turn off [847]	Load limit to end the Overload state in the backward movement at constant speed.	50.0 %
0.0 % ÷ 1000.0 %	After the Overload occurs, the START Command is blocked in the positive direction. Overload expires if during the backward movement at constant speed, the Load [854] (page 22) value drops under the the value defined by this parameter and this condition lasts longer than the defined period Overload period turn off [850] (page 110).	
Overload period turn off [850]	Period during which the Load [854] (page 22) quantity has to be lower than the overload stop limit, so the OPS switch will switch off.	3.00 s
0.01 s ÷ 320.00 s		
OPS reset [858]	The OPS reset command will be active if at least one of the selected binary inputs or logical blocks will be active. This command is used as an Overload Protection Switch turn off condition in case it switched on. It can be necessary during reviews or inspections of the technological device and should be activated with high caution.	
Look choises of parameter's Bit1 DS mask [553] (page 55)		

DYNAMIC LIFT (DL)

Group of parameters number [1068]

Setting the parameters of the Dynamic lift function.

MENU \ SETTINGS \ FUNCTIONS \ LIFTING FUNCTIONS \ DYNAMIC LIFT (DL)

Name [ID]	Description	Def.
DL on/off [1069]	Turning on / off the dynamic lift (DL) function. During the ramp-up in the positive direction, frequency stops on DL frequency [1073] (page 111) for the time of DL measurement period [1070] (page 110) to settle the quantity Load [854] (page 22) and calculation of the new speed restriction. If the load settles in the interval between the values DL minimal load [1072] (page 111) and DL maximal load [1071] (page 111), then the speed restriction of the lift-up is converted linearly between the values DL frequency [1073] (page 111) and Max. frequency [111] (page 73).	Turned off
Turned off	Dynamic lift is inactive.	
Turned on	Dynamic lift is active.	
DL measurement	Period of measurement of the static load on the frequency DL frequency [1073]	1.00 s

Name [ID]	Description	Def.
period [1070]	(page 111).	
0.01 s ÷ 320.00 s	This time is used to settle the quantity Load [854] (page 22).	
DL maximal load [1071]	The upper load limit, above which the maximum frequency is not further reduced.	100.0 %
0.0 % ÷ 1000.0 %	If the lift will be loaded to the value of this parameter or higher, its maximal speed will be restricted to the value of DL frequency [1073] (page 111).	
DL minimal load [1072]	The lower load limit, below which the drive operates at maximum frequency.	50.0 %
0.0 % ÷ 1000.0 %	If the lift will be loaded to the value of this parameter or lower, its maximal speed will be restricted to the value Max. frequency [111] (page 73).	
DL frequency [1073]	Frequency, at which the load measuring runs and at the same the minimal speed that corresponds with the maximal load.	50.0 Hz
Brake frequency [522] ÷ Max. frequency [111]		

7.7.7 EXTERNAL THERMAL PROTECTION (ETP)

Group of parameters number [860]

Setting the external thermal protection (ETP) evaluation block. Sensor type selection (PT100, PTC, Custom). External temperature faults and warnings configuration. For proper operation of ETP, it is necessary to properly configure the corresponding AOUTx and AINx in the [216] (page 79) group.

MENU \ SETTINGS \ FUNCTIONS \ EXTERNAL THERMAL PROTECTION (ETP)

Name [ID]	Description	Def.
ETP Type [861]	Turning on / off the external thermal protection (ETP) function and selecting the connected temperature sensor type. Number of sensors connected in series is set by the parameter Sensor count [862] (page 111).	ETP turned off
ETP turned off	Converter does not evaluate external temperature.	
PT100	External temperature sensor is one or more PT100 sensors.	
KTY83/85	External temperature sensor is one or more KTY 83/110, 83/120 or KTY 85/1, KTY 85/110, 85/120, 85/150 sensors.	
KTY81/82	External temperature sensor is one or more KTY 81/110, 81/120, 81/150 or KTY 82/110, 82/120, 82/150 sensors.	
Custom sensor	External temperature sensor is one or more user defined temperature sensors, which transmission characteristics is defined by the Resistance by 20°C [863] (page 112) and Resistance in 100°C [864] (page 112) parameters/	
PTC thermistor	External temperature sensor is one or more PTC thermistors, which threshold temperature is defined in the ETP Fault [866] (page 112) parameter. ETP warning occurs after exceeding the sensor resistance beyond 300 ohm and an ETP fault occurs after exceeding the sensor resistance beyond 1000 ohm. Drop under 550 ohm causes the fault to disappear.	
KTY84	External temperature sensor is one or more KTY 84/130, KTY 84/150, KTY 84/151 sensors.	
KTY83/85 2k	External temperature sensor is one or more KTY 83/150, KTY 85/151, KTY 85/152 sensors.	
KTY81/82 2k	External temperature sensor is one or more KTY 81/220, 81/250 or KTY 82/220, 82/250 sensors.	
Voltage source ETP [906]	ETP sensor voltage measurement source signal settings. It is also necessary to feed the sensor from an analog output, whose function is selected as "ETP Current".	AIN1
AIN1	Voltage on the thermal sensor is connected to AIN1 (0-10V).	
AIN2	Voltage on the thermal sensor is connected to AIN2 (0-10V).	
AIN3	Voltage on the thermal sensor is connected to AIN3 (0-10V).	
AIN4	Voltage on the thermal sensor is connected to AIN4 (0-10V)	
Special	The source of the measurement is the special signal U ETP Signal [857] (page 112).	
AIN-RM - Servo	Voltage on the thermal sensor is connected to AIN-RM (0-10V) - the exact voltage input for SERVOFREM.	
Sensor count [862]	Serially connected external temperature sensors count.	1

Name [ID]	Description	Def.
1 ÷ 10	In case the motor or other device is equipped with multiple identical temperature sensors (coils, bearings), it is possible to connect them serially, and the count will be defined in this parameter. Any combination of thermal sensors in the windings and bearings is not allowed!	
ETP Warning [865]	Temperature in the external sensor temperature scanning point, in which the converter generates warning " W13-External temperature (page 28)".	90.0 °C
-500.0 °C ÷ 500.0 °C	In case that there are multiple serially connected sensors of an identical type, it is the average temperature from the multiple measuring points.	
ETP Fault [866]	Temperature, in which the converter generates increased temperature faults in the external sensor temperature scanning point. Represents the threshold sensor temperature by 1000ohm when using the ETP=PTC thermistor type. Fault occurs after exceeding this temperature.	110.0 °C
-500.0 °C ÷ 500.0 °C	In case that there are multiple serially connected sensors of an identical type, it is the average temperature from the multiple measuring points.	
ETP hysteresis [1237]	Hysteresis of ETP fault and warning deactivation.	2.5 °C
0.0 °C ÷ 1000.0 °C		
Low ETP temperature [1283]	When ETP temperature drops below this value, converter generates a fault E38-ETP temperature (page 33) because of the extremely low temperatures, which can be caused by incorrect wiring or damage of ETP sensor. When ETP Type set to "PTC thermistor", this parameter has no meaning.	-100.0 °C
-500.0 °C ÷ 500.0 °C		
ETP maximal current [1087]	Maximal ETP measuring current.	10.00 mA
0.01 mA ÷ 20.00 mA	Restricts the current to the EHP sensors to prevent undesired overheating of the sensor. If a special sensor is used, it is necessary to set the maximal current according to its specification. In the EHP = PTC type, the measuring current is limited to the 1mA value and in the PT100 type to 3mA and then this parameter is inactive.	

CUSTOM SENSOR

Group of parameters number [810]

Setting the characteristic of the custom ETP sensor (if "Custom sensor" is selected in ETP Type [861] (page 111)).

MENU \ SETTINGS \ FUNCTIONS \ EXTERNAL THERMAL PROTECTION (ETP) \ CUSTOM SENSOR

Name [ID]	Description	Def.
Resistance by 20°C [863]	Resistance value of an external temperature sensor in 20°C, in case that the sensor characteristics is user-defined.	1200.0 Ω
0.1 Ω ÷ 99000.0 Ω		
Resistance in 100°C [864]	Resistance value of an external temperature sensor in 100°C, in case that the sensor characteristics is user-defined.	4600.0 Ω
0.1 Ω ÷ 99000.0 Ω		

SPECIAL SETTING ETP

Group of parameters number [569]

Special source setting for the ETP voltage drop measurement.

MENU \ SETTINGS \ FUNCTIONS \ EXTERNAL THERMAL PROTECTION (ETP) \ SPECIAL SETTING ETP

Name [ID]	Description	Def.
U ETP Signal [857]	Selecting the signal, which should be evaluated as voltage on the ETP sensor.	-
Signal	Usually an analog input in the 0 to 10 V mode is used.	

7.7.8 IRC1,2 DIFFERENCE

Group of parameters number [1081]

Setting the IRC1 and IRC2 encoders frequency difference operation. Encoder IRC difference is used to adapt the behaviour of multi-motor drive during unequal speed of single motors caused by external influences. For example, the front and rear axle traction vehicle. The value of Freq. IRC1-IRC2 gear [1086] (page 19) is calculated as the absolute value of the difference of the absolute values of the quantities Freq. IRC1 [434] (page 19) and Freq. IRC2 [803] (page 19).

MENU \ SETTINGS \ FUNCTIONS \ IRC1,2 DIFFERENCE

Name [ID]	Description	Def.
IRC1,2 Detuning [1082]	Setting the operation method and the converter operation when detuning the IRC1 and IRC2 speed.	
<input type="checkbox"/> Torque limitation	After exceeding the minimal limit if the IRC1 and IRC2 frequency difference Minimal IRC1,2 difference [1084] (page 113), the motor torque will start to be limited and at the maximal difference Maximum IRC1,2 difference [1085] (page 113), the torque will be limited to zero.	
<input type="checkbox"/> Reset PWM	After exceeding the maximal limit if the IRC1 and IRC2 frequency difference Maximum IRC1,2 difference [1085] (page 113), PWM RESET will be generated and at the minimal difference Minimal IRC1,2 difference [1084] (page 113), operation is permitted again.	
Filter dIRC1,2 [1083]	Time constant of the IRC1 and IRC2 frequency difference filter.	100 ms
0 ms ÷ 10000 ms	It helps to eliminate short differences caused by short dynamic shocks and unequal loads. Filter is inactive if the value is set to 0s.	
Minimal IRC1,2 difference [1084]	Minimal limit of the absolute value for the IRC1 and IRC2 frequency difference.	2.00 Hz
0.00 ÷ Maximum IRC1,2 difference [1085]		
Maximum IRC1,2 difference [1085]	Maximal limit of the absolute value for the IRC1 and IRC2 frequency difference.	5.00 Hz
0.00 Hz ÷ 500.00 Hz		

7.7.9 DIFFERENTIAL

Group of parameters number [1239]

Parameters for the differential e.g. for the needs of torque equalization for center differential.

MENU \ SETTINGS \ FUNCTIONS \ DIFFERENTIAL

Name [ID]	Description	Def.
Sig.1 Source [1248]	Signal 1 value source.	[69] Torque
Signal		
Sig.1 Value [1249]	Value 1 for PI controller of differential.	0.00
-1000000000.00 ÷ 1000000000.00		
Sig.2 Source [1247]	Signal 2 value source.	-
Signal		
Sig.2 Value [1240]	Value 2 for PI controller of differential.	0.00
-1000000000.00 ÷ 1000000000.00		
Max. freq. diff. [1241]	The maximum value of the action to setpoint frequency.	0.00 Hz
0.00 Hz ÷ 20.00 Hz		
P gain of diff. [1242]	Proportional gain of controller of the differential.	0.0000
-100.0000 ÷ 100.0000		
I gain of diff. [1246]	Integral gain of controller of the differential.	0.0000
-100.0000 ÷ 100.0000		

7.8 FAULTS AND WARNINGS

Group of parameters number [136]

Setting the parameters affecting the conditions of generation and termination of converter fault states.

MENU \ SETTINGS \ FAULTS AND WARNINGS

Name [ID]	Description	Def.
Clear history [500]	This command clears the converter fault history. There will be no record in the history.	

7.8.1 OPTIONAL FAULTS

Group of parameters number [190]

Turning on / off the evaluation of some fault states.

MENU \ SETTINGS \ FAULTS AND WARNINGS \ OPTIONAL FAULTS

Name [ID]	Description	Def.
Input phase loss [337]	Turning on the converter input phase loss evaluation. It is recommended to leave the input phase loss evaluation turned on, because in the converter continuous two-phase operation there is a risk of damage to the power capacitors. It is turned off in special cases only, when the supply grid is of poor quality or when the fault " E13-Input phase loss (page 32)" interrupts the operation unnecessary often.	Is evaluated
Is not evaluated	Fault " E13-Input phase loss (page 32)" or " E55-Rectifier fault (VDC) (page 34)" is not evaluated.	
Is evaluated	Fault " E13-Input phase loss (page 32)" or " E55-Rectifier fault (VDC) (page 34)" is evaluated.	
Output phase loss [338]	Turning on the converter output phases loss evaluation. The criteria for evaluation of this fault is current phase asymmetry of 30%, calculated from the nominal current of the converter.	Is evaluated
Is not evaluated	Fault " E2-Output phase outage (page 32)" is not evaluated.	
Is evaluated	Fault " E2-Output phase outage (page 32)" is evaluated.	
Output phase loss sens. [1597]	Output phase loss sensitivity. 0% represents no sensitivity, 100% represents maximum sensitivity.	30 %
1 % ÷ 100 %		
Motor overloading [27]	Setting the method of evaluating the motor (load) thermal overloading.	Self-cooling
Not evaluated	Converter does not evaluate the thermal overload of the connected device.	
Self-cooling	Fault " E29-Motor overload (page 33)" is evaluated according to the motor temperature model considering the motor rotation speed. In this mode, the generation of warning " W17-MT Overload (page 29)" or fault " E29-Motor overload (page 33)" at low motor speed may occur even for current lower than Nom. current [151] (page 43).	
Forced cooling	Fault " E29-Motor overload (page 33)" is evaluated according to the motor temperature model without considering the motor rotation speed.	
AIN Fault [837]	This parameter turns on / off the evaluation of analog input faults. The fault is evaluated only if the input is set to 4-20mA or 2-10V, output value is under the minimal value and the fault evaluation is turned on.	Is evaluated
Is evaluated	If the analog input is for a long time under the minimal value, the converter generates the fault.	
Is not evaluated	Converter accepts any analog input value.	
Overfrequency [85]	Turning on the fault evaluation for exceeding the stator limit frequency. Fault " E10-Overfrequency (page 32)" can indicate controller loop faults or incorrect parameters settings. This fault protects the mechanical components of the device when the converter and technological device positions increase the converter output frequency beyond control. Fault occurs, if the output frequency exceeds the value Overfrequency limit [97] (page 114). Origin of this fault may indicate incorrect configuration of the control algorithms.	Is evaluated
Is not evaluated	Fault " E10-Overfrequency (page 32)" is not evaluated.	
Is evaluated	Fault " E10-Overfrequency (page 32)" is evaluated.	
Overfrequency limit [97]	Defines the stator frequency limit for evaluation of the fault " E10-Overfrequency (page 32)".	520.00 Hz
Max. frequency [111] ÷ 600.00	Fault occurs if the fault evaluation is turned on in Overfrequency [85] (page 114) and the converter output frequency exceeds this limit for a time longer than 1 second.	
External fault source [225]	Setting the source of the external fault. If the source is active, the fault " E7-External fault (page 32)" is generated. Is used as an emergency stop. Fault	None

Name [ID]	Description	Def.
	blocks the converter operation.	
Look choises of parameter's Quick stop source. [986] (page 49)		

SPECIAL EXT. ERROR

Group of parameters number [554]
 Setting the special source of the external fault.

MENU \ SETTINGS \ FAULTS AND WARNINGS \ OPTIONAL FAULTS \ SPECIAL EXT. ERROR

Name [ID]	Description	Def.
Ext. fault signal [527]	Signal that is evaluated if the fault " E7-External fault (page 32)" occurs or not. Either numeric or discrete signal can be chosen.	[184] Binary inputs
Signal		
External fault [528]	Conditions for external fault.	
Look choises of parameter's Binary inputs [184] (page 18)		
External fault inactive [529]	External fault deactivation: In case of a numeric signal if the signal value is lower than the defined level.	
Look choises of parameter's Binary inputs [184] (page 18)		

LOW DECELERATION

Group of parameters number [687]
 Parameters for detection of too low deceleration (low deceleration value), where there is a risk of exceeding the longest safe braking distance.

MENU \ SETTINGS \ FAULTS AND WARNINGS \ OPTIONAL FAULTS \ LOW DECELERATION

Name [ID]	Description	Def.
Low decel. detection mode [686]		
<input type="checkbox"/> Positive direction	Deceleration is detected from positive values of Speed m/s [68] (page 17) towards 0.	
<input type="checkbox"/> Negative direction	Deceleration is detected from negative values of Speed m/s [68] (page 17) towards 0.	
<input type="checkbox"/> Warning/Fault	If this option is active, fault E46-Low deceleration (page 34) is generated. Otherwise warning W70-Low deceleration (page 31) is generated.	
Low deceleration limit [685]	The deceleration rate below which there is a risk of extending the longest possible safe stopping distance. Acceleration m/s ² [684] (page 17) is used for evaluation.	0.0000 m/s ²
0.0000 m/s ² ÷ 10.0000 m/s ²		

7.8.2 ENC. FAULTS

Group of parameters number [990]
 Setting the fault evaluation of the encoders.

MENU \ SETTINGS \ FAULTS AND WARNINGS \ ENC. FAULTS

Name [ID]	Description	Def.
Encoder fault mode [535]	Turning on the testing of motor rotation speed sensor loss and the configuration of the testing method. Fault evaluation is recommended for closed loop control with the feedback from the encoder. Selecting the evaluation method of IRC/ARC encoder fault evaluated by the extension module and the converter control board.	Wrong direction
<input type="checkbox"/> ERR output RM-IRC	Fault " E32-IRC fault (page 33)" is evaluated during missing or incomplete signals A, AN, B, BN, I, IN.	
<input type="checkbox"/> Incorrect reverses of IRC1	Fault " E32-IRC fault (page 33)" is evaluated during high presence of incorrect IRC1 reverses at high speed.	
<input type="checkbox"/> Incorrect reverses of IRC2	Fault " E32-IRC fault (page 33)" is evaluated during high presence of incorrect IRC2 reverses at high speed.	

Name [ID]	Description	Def.
<input type="checkbox"/> Switch to OPEN	If this option is active, during the IRC for ramp-down the converter generates only warnings and switches to an open scalar or vector control.	
<input type="checkbox"/> Warning only	IRC fault maintenance will operate according to previous options, but it will not generate the fault, only a warning.	
<input type="checkbox"/> Blocked rotor	The fault " E43-Blocked rotor (page 34)" is evaluated in the vector control with saturated torque or current controllers and speed being close to zero for longer time. When controlling SMPM, it also detects the wrong direction of the encoder.	
<input type="checkbox"/> Speed step change	Fault " E44-Encoder speed step change (page 34)" is generated during high, unlike speed step change.	
<input checked="" type="checkbox"/> Wrong direction	Warning " W59-Incorrect IRC/ARC direction (page 31)" or fault " E59-Incorrect IRC/ARC direction (page 34)" are generated when wrong IRC or ARC direction is detected.	
<input type="checkbox"/> High frequency	Fault " E60-High IRC/ARC freq. (page 34)" is evaluated after exceeding the speed set by the parameter High freq. encoder [1612] (page 116).	
Incor. rev. IRC sensitivity [9]	Setting the sensitivity of "Incorrect reverses of IRC1/IRC2" faults.	4
1 ÷ 10	IRC fault sensitivity is lowest when value 1 is set and highest when the value 10 is set.	
Incor. rev. IRC time filter [903]	IRC fault reaction period for "Incorrect reverses of IRC1/IRC2" faults.	0.100 s
0.001 s ÷ 300.000 s		
High freq. encoder [1612]	Threshold frequency from speed measurement sensor used for control feedback by the parameter Speed source [1000] (page 58), interpreted as electrical, not mechanical frequency.	200 Hz
Max. frequency [111] ÷ 5000	If the fault evaluation is turned on by selecting "High frequency" in parameter Encoder fault mode [535] (page 115), fault " E32-IRC fault (page 33)" is generated when this frequency is exceeded.	

7.8.3 FAULT ACKNOWLEDGEMENT

Group of parameters number [164]

Mode of operation after the fault and conditions settings for the converter block after a high number of faults.

MENU \ SETTINGS \ FAULTS AND WARNINGS \ FAULT ACKNOWLEDGEMENT

Name [ID]	Description	Def.
Fault acknowledgement source [165]	Setting the method of acknowledgement the fault state. If the cause no longer exists (high current, low voltage), the fault state ends - will be confirmed by the configured fault confirmation method.	Control panel BIN MODBUS PROFIBUS Special
<input checked="" type="checkbox"/> Control panel	Fault will be acknowledged by the control panel.	
<input checked="" type="checkbox"/> Automatically	Fault will be acknowledged automatically.	
<input checked="" type="checkbox"/> BIN	Fault is acknowledged by activating the selected binary input.	
<input checked="" type="checkbox"/> MODBUS	Fault is acknowledged over the MODBUS communication interface.	
<input checked="" type="checkbox"/> PROFIBUS	Fault is acknowledged over the PROFIBUS communication interface.	
<input checked="" type="checkbox"/> Special	Fault is acknowledged over the special settings [566] (page 117).	
Acknowl. BIN [1588]	Conditions for fault acknowledgement from binary inputs.	
	Look choises of parameter's Bit1 DS mask [553] (page 55)	
Time after fault [428]	When the cause of the fault no longer exists (for example overcurrent), the fault duration time will be prolonged by the defined time.	5.0 s
0.0 s ÷ 3600.0 s	E.g. 5 s means that every fault will last for at least 5 seconds.	
Max. fault count [431]	Maximal fault count that can occur in the time defined by Min. fault period [432] (page 116).	5
5 ÷ 20	Protects the converter or device against frequent faults, which could cause permanent damage to the converter or connected device. If a certain frequency of fault occurrence is exceeded, the converter generates the fault " E31-Too many faults (page 33)".	
Min. fault period [432]	Time, in which the maximal fault count can occur Max.	24.0 h

Name [ID]	Description	Def.
	fault count [431] (page 116). If there are more faults, the fault " E31-Too many faults (page 33)" is generated.	
5.0 h ÷ 72.0 h		

SPECIAL SETTING

Group of parameters number [566]

Setting the special source of fault confirmation, e.g. in the chosen time of day or over the analog input.

MENU \ SETTINGS \ FAULTS AND WARNINGS \ FAULT ACKNOWLEDGEMENT \ SPECIAL SETTING

Name [ID]	Description	Def.
Acknowledgement signal [509]	Signal for fault acknowledgement.	[184] Binary inputs
Signal		
Acknowledgement [510]	Condition of fault acknowledgement.	
Look choices of parameter's Binary inputs [184] (page 18)		
Confirmation inactive [511]	Confirmation inactive: In case of a numeric signal if the signal value is lower than the defined level.	
Look choices of parameter's Binary inputs [184] (page 18)		

7.8.4 QUANTITIES TO LOG

Group of parameters number [246]

Selection of quantities, which should be logged to history when an event occurs (faults, warnings...).

MENU \ SETTINGS \ FAULTS AND WARNINGS \ QUANTITIES TO LOG

Name [ID]	Description	Def.
Value 1 [247]	Selection of the first optional quantity which will be logged to the history. When an event occurs (fault), its actual value will be stored.	[75] CB temperature
Signal		
Value 2 [248]	Selection of the second optional quantity which will be logged to the history. When an event occurs (fault), its actual value will be stored.	[74] Cooler temperature
Signal		
Value 3 [249]	Selection of the third optional quantity which will be logged to the history. When an event occurs (fault), its actual value will be stored.	[76] Converter state
Signal		
Do not log [746]	Determines if some faults will not be logged to the fault history. This parameter does not influence the fault evaluation itself.	
<input type="checkbox"/> Undervoltage	Fault " E5-Undervoltage (page 32)" will not be logged to the fault history.	
<input type="checkbox"/> Supply overload	Fault " E16-Supply overload (page 32)" will not be logged to the fault history.	
<input type="checkbox"/> Safety input	Fault " E14-Safety input (page 32)" will not be logged to the fault history.	
<input type="checkbox"/> Supply overl. PWM off	Fault " E16-Supply overload (page 32)" will not be logged to the fault history when the PWM is off.	
<input type="checkbox"/> Supply overl. stopping	Fault " E16-Supply overload (page 32)" will not be logged to the fault history after the Start command is off until the PWM is off.	
Par. changed [1175]	Allows creating the parameter changes history.	Control panel
<input checked="" type="checkbox"/> Control panel	All parameter changes by control panel are recorded.	
<input type="checkbox"/> MODBUS	All parameter changes over MODBUS are recorded.	
<input type="checkbox"/> PROFIBUS	All parameter changes over PROFIBUS are recorded.	

7.8.5 WARNINGS

Group of parameters number [964]

Setting the conditions of generating the individual warnings and their storing to the fault history.

MENU \ SETTINGS \ FAULTS AND WARNINGS \ WARNINGS

Name [ID]	Description	Def.
-----------	-------------	------

Name [ID]	Description	Def.
Warnings [705]	Restricts the displayed warnings to the list of more important warnings.	Basic
Basic	Some warnings, which are not necessary for basic users, will be suppressed.	
Expert	All available warnings and function messages will be displayed.	
Cooler temperature warning [767]	Temperature, at which the cooler displays a warning " W6-Cooler temperature (page 28)".	75.0 °C
40.0 ÷ Fault ⁹	⁹ Refer to chapter 3.2 Temperatures (str. 14) by product type.	
IGBT chip temp. warning [99]	IGBT chip temperature, at which the warning " W11-IGBT temperature (page 28)" is displayed.	75.0 °C
20.0 ÷ Fault ¹⁰	If the temperature based power restriction is enabled in Power restriction (PR) [766] (page 78), power is reduced when temperature is very high to suppress the overheating of the inverter. ¹⁰ Refer to chapter 3.2 Temperatures (str. 14) by product type.	
CB temperature warning [204]	Temperature, at which the converter displays a Control board (CB) overheat warning " W7-CB temperature (page 28)".	55.0 °C
20.0 ÷ Fault ³	³ Refer to chapter 3.2 Temperatures (str. 14) by product type.	
External warning source [560]	External warning source settings. If the source is active, the warning " W49-External warning (page 30)" becomes active. It is used as signalization of any desired event. It does not influence the converter operation.	None
Look choises of parameter's Quick stop source. [986] (page 49)		
Warning log [968]	Selection from warnings 1-32, which will be logged to the fault history at the time they occur.	
Look choises of parameter's Warning [250] (page 24)		
Warning log 2 [969]	Selection from warnings 33-64, which will be logged to the fault history at the time they occur.	
Look choises of parameter's Warning2 [424] (page 24)		
Warning log 3 [912]	Selection from warnings 65-96, which will be logged to the fault history at the time they occur.	
Look choises of parameter's Warning3 [1627] (page 24)		

SPECIAL SETTING

Group of parameters number [563]

Setting the special source of external warning

MENU \ SETTINGS \ FAULTS AND WARNINGS \ WARNINGS \ SPECIAL SETTING

Name [ID]	Description	Def.
Ext. warning signal [965]	Signal that is evaluated if the warning " W49-External warning (page 30)" occurs or not. It is used as an external event warning. Warning does not block the converter operation. Either numeric or discrete signal can be chosen.	[184] Binary inputs
Signal		
Ext. warning [966]	Conditions for external warning.	
Look choises of parameter's Binary inputs [184] (page 18)		
Ext. warning inactive [967]	External warning is deactivated: In case of a numeric signal if the signal value is lower than the defined level.	
Look choises of parameter's Binary inputs [184] (page 18)		

7.9 DISPLAY

Group of parameters number [48]

Selecting the parameters displayed on the control panel.

7.9.1 DISP. QUANT. SETTINGS

Group of parameters number [88]

Displayed quantities settings. Quantities that are displayed in the upper part of the display in the MONITOR, SETTINGS and DIAGNOSTICS window.

Name [ID]	Description	Def.
DV 1 [51]	Selecting the first displayed quantity.	[210] Date
Signal		
DV 2 [52]	Selecting the second displayed quantity.	[209] Time
Signal		

7.9.2 MONITOR SETTING

Group of parameters number [1214]

Displayed quantities settings. Quantities that are displayed in the upper part of the display in the MONITOR, SETTINGS and DIAGNOSTICS window.

Name [ID]	Description	Def.
Monitor 1 [53]	Selecting the quantity that will be displayed in the monitor window in the first row.	[47] Freq. INV
Signal		
Monitor 2 [54]	Selecting the quantity that will be displayed in the monitor window in the second row.	[46] Voltage DC
Signal		
Monitor 3 [55]	Selecting the quantity that will be displayed in the monitor window in the third row.	[42] Current MT
Signal		
Monitor 4 [56]	Selecting the quantity that will be displayed in the monitor window in the fourth row.	[184] Binary inputs
Signal		
Monitor 5 [57]	Selecting the quantity that will be displayed in the monitor window in the fifth row.	[74] Cooler temperature
Signal		
Timeout panel [198]	Setting the communication timeout for the control panel.	100 ms
15 ms ÷ 200 ms		
LANGUAGE [231]	Language change.	Slovensky
Slovensky English Polski		

7.10 COMMUNICATION

Group of parameters number [213]

Setting the serial communication of the converter.

Name [ID]	Description	Def.
Converter address [234]	Address is used for identification of the device. It is the sum of preset address and Address shift [1155] (page 119). It is also used for the communication with the control panel. In case that more converters are connected, every converter has to have unique address.	1
1 ÷ 99		
Address shift [1155]	Selection of bits, which create the external address. The weight of the bits is applied by the order of the selections. Communication address is then calculated as a sum of the external address and the parameter Converter address [234] (page 119).	
Look choises of parameter's Bit1 DS mask [553] (page 55)		
Statistics reset [238]	Statistics reset in the serial communication diagnostics. (number of messages, number of fault messages,...)	

7.10.1 MODBUS

Group of parameters number [658]

Setting the MODBUS communication protocol. VONSCH implementation of MODBUS protocol is MODBUS RTU specification compliant.

Detailed description of MODBUS communication protocol can be found on www.vonsch.sk, in the section Support.

MENU \ SETTINGS \ COMMUNICATION \ MODBUS

Name [ID]	Description	Def.
Baud RS485 [218]	RS 485 serial port communication baud rate setting.	115,200s Bps
9600 Bps		
19,200 Bps		
38,400 Bps		
57,600 Bps		
115,200 Bps		
128,000 Bps		
115,200s Bps	Baud rate with corrected timing between frames, suitable for SIMATIC S7-1200.	
Baud ext. module [230]	Extension module serial port communication speed. Extension module is optional.	115,200s Bps
Look choises of parameter's Baud RS485 [218] (page 120)		
MB Idle [961]	Selecting how the converter should react when it is not communicating with the Modbus master. After the defined idle time the warning occurs, or the fault. Or first the warning and then the fault.	
<input type="checkbox"/> Fault	The converter generates the fault " E42-Modbus Timeout (page 34)", when no valid request or broadcast (if allowed) is received from the Modbus master within the preset time.	
<input type="checkbox"/> Warning	The converter generates the warning " W42-Modbus Timeout (page 30)", when no valid request or broadcast (if allowed) is received from the Modbus master within the preset time.	
<input type="checkbox"/> Fault CW	The converter generates the fault " E42-Modbus Timeout (page 34)", when no control word or setpoint is received in valid request or broadcast(if allowed) from the Modbus master within the preset time.	
<input type="checkbox"/> Warning CW	The converter generates the warning " W42-Modbus Timeout (page 30)", when no control word or setpoint is received in valid request or broadcast(if allowed) from the Modbus master within the preset time.	
MB Fault timeout [659]	Timeout of communication interruption with Master. After this time, fault E42-Modbus Timeout (page 34) is generated.	5.00 s
0.10 s ÷ 3600.00 s		
MB Warning timeout [962]	Timeout of communication interruption with Master. After this time, warning " W42-Modbus Timeout (page 30)" is generated. If a Modbus protocol fault and warning are evaluated at the same time, see MB Idle [961] (page 120), then this parameter must be lower than the parameter MB Fault timeout [659] (page 120), otherwise the warning will not be generated.	2.00 s
0.10 s ÷ 3600.00 s		
MB Warning mode [963]	Defines what action should the converter take after Modbus warning occurs.	Reset
Look choises of parameter's PB Warning mode [816] (page 123)		
Broadcast [1156]	Turning on / off the broadcasts. Broadcast is a message which is sent to all recipients simultaneously.	Yes
Yes	Broadcasts are turned on and the converter is processing them.	
No	Broadcasts are turned off and the converter is ignoring them.	
DataFormat [660]	This parameter defines the order of transferring single bytes. This change of format is only applied for the 485 line. This is the parameter data, SW, CW, and accelerated block transfer. By default, 32-bit data 0xHhHILhLI is transmitted in the order 0xHh, 0xHI, 0xLh, 0xLI.	No swap
No swap	32 bit data are transfered in the byte order: 0xHh, 0xHI, 0xLh, 0xLI.	
Byte swap	32 bit data are transfered in the byte order: 0xHI, 0xHh, 0xLI, 0xLh.	
Word swap	32 bit data are transfered in the byte order: 0xLh, 0xLI, 0xHh, 0xHI.	

Name [ID]	Description	Def.
Byte & word swap	32 bit data are transfered in the byte order: 0xLI, 0xLh, 0xHI, 0xHh.	
MB counters [1556]	Selection of physical lines to check for being idle and increment communication counters.	RS485 Ext. module
<input type="checkbox"/> USB <input checked="" type="checkbox"/> RS485 <input checked="" type="checkbox"/> Ext. module		

Parameters MODBUS

Group of parameters number [573]

Parameter selection (mapping) for the Modbus communication fast block transfer.

MENU \ SETTINGS \ COMMUNICATION \ MODBUS \ PARAMETERS MODBUS

Name [ID]	Description	Def.
ID 0 [1094]		-
Signal		
ID 1 [1095]		-
Signal		
ID 2 [1096]		-
Signal		
ID 3 [1097]		-
Signal		
ID 4 [1098]		-
Signal		
ID 5 [1099]		-
Signal		
ID 6 [1100]		-
Signal		
ID 7 [1101]		-
Signal		
ID 8 [1102]		-
Signal		
ID 9 [1103]		-
Signal		
ID 10 [1104]		-
Signal		
ID 11 [1105]		-
Signal		
ID 12 [1106]		-
Signal		
ID 13 [1107]		-
Signal		
ID 14 [1108]		-
Signal		
ID 15 [1109]		-
Signal		
ID 16 [1110]		-
Signal		
ID 17 [1111]		-
Signal		
ID 18 [1112]		-
Signal		
ID 19 [1113]		-
Signal		

Name [ID]	Description	Def.
ID 20 [1114] Signal		-
ID 21 [1115] Signal		-
ID 22 [1116] Signal		-
ID 23 [1117] Signal		-
ID 24 [1118] Signal		-
ID 25 [1119] Signal		-
ID 26 [1120] Signal		-
ID 27 [1121] Signal		-
ID 28 [1122] Signal		-
ID 29 [1123] Signal		-
ID 30 [1124] Signal		-
ID 31 [1125] Signal		-
ID 32 [1126] Signal		-
Shift value [1512] -99 ÷ 99	It is used for special holding registers over broadcast.	1
Shift mask [1513]	It is used for special holding registers over broadcast.	
Look choises of parameter's Bit1 DS mask [553] (page 55)		
Step 0 [1514] -8 ÷ 8	Setting of the step. It serves to determine how to recalculate 16-bit special holding register to the selected variable set by ID 0. For selected value 0, 16bit number 123 is recalculated to 32bit number as 123. For value 1, 123 is recalculated as 12.3.	0

7.10.2 PROFIBUS

Group of parameters number [812]

Profibus is an open serial communication standard. Extension module Vonsch Profibus_UNI fully supports the Profibus DP standard.

Detailed description of PROFIBUS communication protocol can be found on www.vonsch.sk, in the section Support.

MENU \ SETTINGS \ COMMUNICATION \ PROFIBUS

Name [ID]	Description	Def.
PB Idle [813]	Selecting the way of reaction of the converter to communication error, when either converter or master do not communicate with the Profibus module. After the defined idle time, warning " W41-Profibus Timeout (page 30)" or fault " E37-Profibus Timeout (page 33)" is generated. <input type="checkbox"/> Fault <input type="checkbox"/> Warning	
PB Fault timeout [814] 0.10 s ÷ 3600.00 s	Timeout of communication interruption with Master. After this time, fault E37-Profibus Timeout (page 33) is generated.	5.00 s

Name [ID]	Description	Def.
PB Warning timeout [815]	MODBUS communication timeout, After communication error longer than this time, warning " W41-Profibus Timeout (page 30)" is generated. If a Modbus protocol fault and warning are evaluated at the same time, see PB Idle [813] (page 122), then this parameter must be lower than the parameter PB Fault timeout [814] (page 122), otherwise the warning is not generated.	2.00 s
0.10 s ÷ 3600.00 s		
PB Warning mode [816]	Defines what action should the converter take after warning " W41-Profibus Timeout (page 30)" occurs.	Reset
Reset	Converter goes to reset.	
Stop	Converter stops.	
Quick stop	Converter stops (Quick stop).	
No action	Converter will not respond to warnings.	
PB Type [1486]	Specifies the format of transmission of operational variables.	2 PD values
2 PD values	It is possible to simultaneously transmit two variables only in the format described by the documentation.	
4 PD values	It is possible to transmit 4 values as 16-bit numbers.	
VQFREM	It is possible to transmit 4 values as 16-bit numbers, by addresses VQFREM.	
PB Options [1587]		
<input type="checkbox"/> Normalized	REF and ACT variables will be normalized to 4000h.	
<input type="checkbox"/> Fixed APD	Selection of PD variables, it is set by parameters [1586] (page 123), not by the communication.	

Parameters PROFIBUS

Group of parameters number [1586]

MENU \ SETTINGS \ COMMUNICATION \ PROFIBUS \ PARAMETERS PROFIBUS

Name [ID]	Description	Def.
APD 1 [1578]		[42] Current MT
Signal		
APD 2 [1579]		[66] Power
Signal		
APD 3 [1580]		-
Signal		
APD 4 [1581]		-
Signal		
Dig. [1582] 1	Determining the last transferred digit from the left.	-
- - - - - - - - - - - - - - - -		
Dig. [1583] 2	The magnitude of 10 that determines the last transferred digit from the left. (... , 1 tens, 0 ones, -1 tenths, ..).	-
Look choises of parameter's Dig. 1 [1582] (page 123)		
Dig. [1584] 3	The magnitude of 10 that determines the last transferred digit from the left. (... , 1 tens, 0 ones, -1 tenths, ..).	-
Look choises of parameter's Dig. 1 [1582] (page 123)		
Dig. [1585] 4	The magnitude of 10 that determines the last transferred digit from the left. (... , 1 tens, 0 ones, -1 tenths, ..).	-
Look choises of parameter's Dig. 1 [1582] (page 123)		

7.11 PAR. SETS

Group of parameters number [206]

Selecting a set of parameters for the converter operation.

MENU \ SETTINGS \ PAR. SETS

Name [ID]	Description	Def.
Set switching [657]	Setting the way of switching between the sets.	Combined
Combined	Only the first 2 bits of the binary switch are used. Output set corresponds to the binary combination of these bits. If no bits are active, the 1st set is active. If only 1 bit is active, the 2nd set is active. and so on.	
Single	Every single bit of the binary switch represents one set (bit 1 represents set 2). If more switches are active, the set with the higher sequence number is active. If no binary switch is active, the 1st set is active.	
Parameter	It is possible to set the active set using the Active set [205] (page 124) parameter.	
Active set [205]	Switches the active set of parameters, from which the converter will take its configuration.	Set 1
Set 1	Converter will take its configuration from 1st set of parameters.	
Set 2	Converter will take its configuration from 2nd set of parameters.	
Set 3	Converter will take its configuration from 3rd set of parameters.	
Set 4	Converter will take its configuration from 4th set of parameters.	
Switch while run [1490]	Enabling or disabling of set switching during motor operation.	Enabled
Disabled	Sets can be switched only when motor is not running.	
Enabled	Sets can be switched even when motor is running.	

7.11.1 SET SWITCH

Group of parameters number [222]

Binary set switch setting.

MENU \ SETTINGS \ PAR. SETS \ SET SWITCH

Name [ID]	Description	Def.
Bit1 set source [641]	Setting the 1st bit of the set switch. Its function depends on the Set switching [657] (page 124) parameter setting.	None
	Look choises of parameter's Quick stop source. [986] (page 49)	
Bit2 set source [642]	Setting the 2nd bit of the set switch. Its function depends on the Set switching [657] (page 124) parameter setting.	None
	Look choises of parameter's Quick stop source. [986] (page 49)	
Bit3 set source [643]	Setting the 3rd bit of the set switch. Its function depends on the Set switching [657] (page 124) parameter setting.	None
	Look choises of parameter's Quick stop source. [986] (page 49)	

SPECIAL SETTING

Group of parameters number [224]

Special functions setting for the set switches.

MENU \ SETTINGS \ PAR. SETS \ SET SWITCH \ SPECIAL SETTING

Name [ID]	Description	Def.
Bit1 set signal [645]	Signal that is evaluated if the 1st bit of the binary switch is active. Either numeric or discrete signal can be chosen.	[184] Binary inputs
Signal		
Bit1 set switch-on [646]	Conditions for switching on Bit1.	
	Look choises of parameter's Binary inputs [184] (page 18)	
Bit1 set switch-off [647]	Bit1 switch-off: In case of a numeric signal if the signal value is lower than the defined level.	
	Look choises of parameter's Binary inputs [184] (page 18)	

Name [ID]	Description	Def.
Bit2 set signal [648] Signal	Signal that is evaluated if the 2nd bit of the binary switch is active. Either numeric or discrete signal can be chosen.	[184] Binary inputs
Bit2 set switch-on [649]	Conditions for switching on Bit2.	
Look choises of parameter's Binary inputs [184] (page 18)		
Bit2 set switch-off [650]	Bit2 switch-off: In case of a numeric signal if the signal value is lower than the defined level.	
Look choises of parameter's Binary inputs [184] (page 18)		
Bit3 set signal [651] Signal	Signal that is evaluated if the 3rd bit of the binary switch is active. Either numeric or discrete signal can be chosen.	[184] Binary inputs
Bit3 set switch-on [652]	Conditions for switching on Bit3.	
Look choises of parameter's Binary inputs [184] (page 18)		
Bit3 set switch-off [653]	Bit3 switch-off: In case of a numeric signal if the signal value is lower than the defined level.	
Look choises of parameter's Binary inputs [184] (page 18)		

7.11.2 USER SETS

Group of parameters number [1290]

Settings of user sets. These sets can store up to 20 selected parameters. There is available up to 32 different values for each selected parameter.

MENU \ SETTINGS \ PAR. SETS \ USER SETS

Name [ID]	Description	Def.
Switch sets [1480]	Switching of user sets. Selection of binary combination of individual sets. Its value represents the actual foursome of sets. First three selected bits are applied. Switch switches the foursome of sets 1-4, 5-9, ... Selection of a specific set from the selected foursome depends on the switching of normal sets.	
Look choises of parameter's Bit1 DS mask [553] (page 55)		
Set shift [1483] -31 ÷ 31	Set shift allows to assign different set as intended to the combination of set switch. The set switch is combined as normal and user set switch. If the shift is 0, the binary switch 00000 corresponds to set 1, 00001 - set 2, etc. If the shift is 1, 00000 corresponds to set 2, 00001 - set 3, etc ...	0
User set [1481]	Number of active user set.	

PARAMS SELECT

Group of parameters number [1291]

Selection of 20 parameters that can store up to 32 different values. After selecting the parameter, its value can not be changed in its original location, but in the user sets for the selected set.

MENU \ SETTINGS \ PAR. SETS \ USER SETS \ PARAMS SELECT

Name [ID]	Description	Def.
Param 1 [1300] Signal		-
Param 2 [1301] Signal		-
Param 3 [1302] Signal		-
Param 4 [1303] Signal		-
Param 5 [1304] Signal		-

Name [ID]	Description	Def.
Param 6 [1305]		-
Signal		
Param 7 [1306]		-
Signal		
Param 8 [1307]		-
Signal		
Param 9 [1308]		-
Signal		
Param 10 [1309]		-
Signal		
Param 11 [1310]		-
Signal		
Param 12 [1311]		-
Signal		
Param 13 [1312]		-
Signal		
Param 14 [1313]		-
Signal		
Param 15 [1314]		-
Signal		
Param 16 [1315]		-
Signal		
Param 17 [1316]		-
Signal		
Param 18 [1317]		-
Signal		
Param 19 [1318]		-
Signal		
Param 20 [1319]		-
Signal		

SET 1-4

Group of parameters number [1292]

Settings of selected parameters for sets 1 to 4. Settings of individual sets can be done by F3 key on the control panel, for a particular parameter.

MENU \ SETTINGS \ PAR. SETS \ USER SETS \ SET 1-4

Name [ID]	Description	Def.
N1_1 [1320]		-
- ÷ -		
N1_2 [1321]		-
- ÷ -		
N1_3 [1322]		-
- ÷ -		
N1_4 [1323]		-
- ÷ -		
N1_5 [1324]		-
- ÷ -		
N1_6 [1325]		-
- ÷ -		
N1_7 [1326]		-
- ÷ -		
N1_8 [1327]		-

Name [ID]	Description	Def.
- ÷ -		
N1_9 [1328]		-
- ÷ -		
N1_10 [1329]		-
- ÷ -		
N1_11 [1330]		-
- ÷ -		
N1_12 [1331]		-
- ÷ -		
N1_13 [1332]		-
- ÷ -		
N1_14 [1333]		-
- ÷ -		
N1_15 [1334]		-
- ÷ -		
N1_16 [1335]		-
- ÷ -		
N1_17 [1336]		-
- ÷ -		
N1_18 [1337]		-
- ÷ -		
N1_19 [1338]		-
- ÷ -		
N1_20 [1339]		-
- ÷ -		

SET 5-8

Group of parameters number [1293]

Settings of selected parameters for sets 5 to 8. Settings of individual sets can be done by F3 key on the control panel, for a particular parameter.

MENU \ SETTINGS \ PAR. SETS \ USER SETS \ SET 5-8

Name [ID]	Description	Def.
N5_1 [1340]		-
- ÷ -		
N5_2 [1341]		-
- ÷ -		
N5_3 [1342]		-
- ÷ -		
N5_4 [1343]		-
- ÷ -		
N5_5 [1344]		-
- ÷ -		
N5_6 [1345]		-
- ÷ -		
N5_7 [1346]		-
- ÷ -		
N5_8 [1347]		-
- ÷ -		
N5_9 [1348]		-
- ÷ -		
N5_10 [1349]		-
- ÷ -		

Name [ID]	Description	Def.
N5_11 [1350]		-
- ÷ -		
N5_12 [1351]		-
- ÷ -		
N5_13 [1352]		-
- ÷ -		
N5_14 [1353]		-
- ÷ -		
N5_15 [1354]		-
- ÷ -		
N5_16 [1355]		-
- ÷ -		
N5_17 [1356]		-
- ÷ -		
N5_18 [1357]		-
- ÷ -		
N5_19 [1358]		-
- ÷ -		
N5_20 [1359]		-
- ÷ -		

SET 9-12

Group of parameters number [1294]

Settings of selected parameters for sets 9 to 12. Settings of individual sets can be done by F3 key on the control panel, for a particular parameter.

MENU \ SETTINGS \ PAR. SETS \ USER SETS \ SET 9-12

Name [ID]	Description	Def.
N9_1 [1360]		-
- ÷ -		
N9_2 [1361]		-
- ÷ -		
N9_3 [1362]		-
- ÷ -		
N9_4 [1363]		-
- ÷ -		
N9_5 [1364]		-
- ÷ -		
N9_6 [1365]		-
- ÷ -		
N9_7 [1366]		-
- ÷ -		
N9_8 [1367]		-
- ÷ -		
N9_9 [1368]		-
- ÷ -		
N9_10 [1369]		-
- ÷ -		
N9_11 [1370]		-
- ÷ -		
N9_12 [1371]		-
- ÷ -		
N9_13 [1372]		-

Name [ID]	Description	Def.
- ÷ -		
N9_14 [1373]		-
- ÷ -		
N9_15 [1374]		-
- ÷ -		
N9_16 [1375]		-
- ÷ -		
N9_17 [1376]		-
- ÷ -		
N9_18 [1377]		-
- ÷ -		
N9_19 [1378]		-
- ÷ -		
N9_20 [1379]		-
- ÷ -		

SET 13-16

Group of parameters number [1295]

Settings of selected parameters for sets 13 to 16. Settings of individual sets can be done by F3 key on the control panel, for a particular parameter.

MENU \ SETTINGS \ PAR. SETS \ USER SETS \ SET 13-16

Name [ID]	Description	Def.
N13_1 [1380]		-
- ÷ -		
N13_2 [1381]		-
- ÷ -		
N13_3 [1382]		-
- ÷ -		
N13_4 [1383]		-
- ÷ -		
N13_5 [1384]		-
- ÷ -		
N13_6 [1385]		-
- ÷ -		
N13_7 [1386]		-
- ÷ -		
N13_8 [1387]		-
- ÷ -		
N13_9 [1388]		-
- ÷ -		
N13_10 [1389]		-
- ÷ -		
N13_11 [1390]		-
- ÷ -		
N13_12 [1391]		-
- ÷ -		
N13_13 [1392]		-
- ÷ -		
N13_14 [1393]		-
- ÷ -		
N13_15 [1394]		-
- ÷ -		

Name [ID]	Description	Def.
N13_16 [1395]		-
- ÷ -		
N13_17 [1396]		-
- ÷ -		
N13_18 [1397]		-
- ÷ -		
N13_19 [1398]		-
- ÷ -		
N13_20 [1399]		-
- ÷ -		

SET 17-20

Group of parameters number [1296]

Settings of selected parameters for sets 17 to 20. Settings of individual sets can be done by F3 key on the control panel, for a particular parameter.

MENU \ SETTINGS \ PAR. SETS \ USER SETS \ SET 17-20

Name [ID]	Description	Def.
N17_1 [1400]		-
- ÷ -		
N17_2 [1401]		-
- ÷ -		
N17_3 [1402]		-
- ÷ -		
N17_4 [1403]		-
- ÷ -		
N17_5 [1404]		-
- ÷ -		
N17_6 [1405]		-
- ÷ -		
N17_7 [1406]		-
- ÷ -		
N17_8 [1407]		-
- ÷ -		
N17_9 [1408]		-
- ÷ -		
N17_10 [1409]		-
- ÷ -		
N17_11 [1410]		-
- ÷ -		
N17_12 [1411]		-
- ÷ -		
N17_13 [1412]		-
- ÷ -		
N17_14 [1413]		-
- ÷ -		
N17_15 [1414]		-
- ÷ -		
N17_16 [1415]		-
- ÷ -		
N17_17 [1416]		-
- ÷ -		
N17_18 [1417]		-

Name [ID]	Description	Def.
- ÷ -		
N17_19 [1418]		-
- ÷ -		
N17_20 [1419]		-
- ÷ -		

SET 21-24

Group of parameters number [1297]

Settings of selected parameters for sets 21 to 24. Settings of individual sets can be done by F3 key on the control panel, for a particular parameter.

MENU \ SETTINGS \ PAR. SETS \ USER SETS \ SET 21-24

Name [ID]	Description	Def.
N21_1 [1420]		-
- ÷ -		
N21_2 [1421]		-
- ÷ -		
N21_3 [1422]		-
- ÷ -		
N21_4 [1423]		-
- ÷ -		
N21_5 [1424]		-
- ÷ -		
N21_6 [1425]		-
- ÷ -		
N21_7 [1426]		-
- ÷ -		
N21_8 [1427]		-
- ÷ -		
N21_9 [1428]		-
- ÷ -		
N21_10 [1429]		-
- ÷ -		
N21_11 [1430]		-
- ÷ -		
N21_12 [1431]		-
- ÷ -		
N21_13 [1432]		-
- ÷ -		
N21_14 [1433]		-
- ÷ -		
N21_15 [1434]		-
- ÷ -		
N21_16 [1435]		-
- ÷ -		
N21_17 [1436]		-
- ÷ -		
N21_18 [1437]		-
- ÷ -		
N21_19 [1438]		-
- ÷ -		
N21_20 [1439]		-
- ÷ -		

SET 25-28

Group of parameters number [1298]

Settings of selected parameters for sets 25 to 28. Settings of individual sets can be done by F3 key on the control panel, for a particular parameter.

MENU \ SETTINGS \ PAR. SETS \ USER SETS \ SET 25-28

Name [ID]	Description	Def.
N25_1 [1440]		-
- ÷ -		
N25_2 [1441]		-
- ÷ -		
N25_3 [1442]		-
- ÷ -		
N25_4 [1443]		-
- ÷ -		
N25_5 [1444]		-
- ÷ -		
N25_6 [1445]		-
- ÷ -		
N25_7 [1446]		-
- ÷ -		
N25_8 [1447]		-
- ÷ -		
N25_9 [1448]		-
- ÷ -		
N25_10 [1449]		-
- ÷ -		
N25_11 [1450]		-
- ÷ -		
N25_12 [1451]		-
- ÷ -		
N25_13 [1452]		-
- ÷ -		
N25_14 [1453]		-
- ÷ -		
N25_15 [1454]		-
- ÷ -		
N25_16 [1455]		-
- ÷ -		
N25_17 [1456]		-
- ÷ -		
N25_18 [1457]		-
- ÷ -		
N25_19 [1458]		-
- ÷ -		
N25_20 [1459]		-
- ÷ -		

SET 29-32

Group of parameters number [1299]

Settings of selected parameters for sets 29 to 32. Settings of individual sets can be done by F3 key on the control panel, for a particular parameter.

Name [ID]	Description	Def.
N29_1 [1460]		-
- ÷ -		
N29_2 [1461]		-
- ÷ -		
N29_3 [1462]		-
- ÷ -		
N29_4 [1463]		-
- ÷ -		
N29_5 [1464]		-
- ÷ -		
N29_6 [1465]		-
- ÷ -		
N29_7 [1466]		-
- ÷ -		
N29_8 [1467]		-
- ÷ -		
N29_9 [1468]		-
- ÷ -		
N29_10 [1469]		-
- ÷ -		
N29_11 [1470]		-
- ÷ -		
N29_12 [1471]		-
- ÷ -		
N29_13 [1472]		-
- ÷ -		
N29_14 [1473]		-
- ÷ -		
N29_15 [1474]		-
- ÷ -		
N29_16 [1475]		-
- ÷ -		
N29_17 [1476]		-
- ÷ -		
N29_18 [1477]		-
- ÷ -		
N29_19 [1478]		-
- ÷ -		
N29_20 [1479]		-
- ÷ -		

8 Converter function configuration manual

8.1 Production (factory) settings

UNIFREM 400 XXX frequency converter are shipped with valid production (factory) parameter settings that can be restored at any time using the FACTORY SETTINGS command. Resetting to factory settings is suitable if the converter was already used in an unknown operation or if it is not shipped directly from VONSCH s.r.o. All configuration procedures in this manual are based on this converter setting.

SAVE / RESTORE → Restore parameters → Factory settings (**confirmation F2**)

Restoring of factory settings will overwrite all parameters, including configuration of control, inputs and outputs.

8.2 Motor parameters – MOTOR MACROS – identification

Parameters in the group SETTINGS → LOAD (MOTOR) are important for proper function of individual converter functions. Here are mostly nameplate (nominal) values of a connected device (motor) and also some special parameters whose values are obtained by identification and tuning.

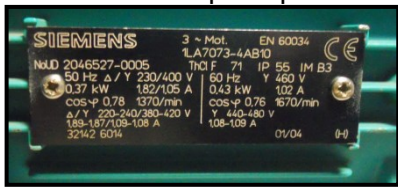
Parameter name	ID	Description
Nom. power [W]	357	Usual motor nameplate parameters. 
Nom. voltage [V]	59	
Nom. frequency [Hz]	4	
Nom. current [A]	151	
Nom. revolutions [ot/min]	356	
Motor power factor	227	
Output phase sequence	326	
Iden. I0 a Lm	384	Turn on / turn off of the magnetizing current identification and magnetizing current value.
Magnetizing current [A]	355	
Time constant MT [s]	79	Parameter of MOTOR MACROS – Time constant of the motor excitation.
Identification RS	383	Turn on / turn off of the identification mode of the stator resistance. and stator resistance value.
Stator resistance [mΩ]	345	
Rotor resistance [mΩ]	439	Special parameters for the proper function of vector control.
Leakage inductance [mH]	440	
Mutual inductance [mH]	441	
Inertia moment [kg m ²]	442	

Preset MOTOR MACROS should be „the springboard“ for the correct converter configuration. Converter connected to the motor should be always functional, after executing the MACRO, and by setting some additional functions. Required higher control quality is achieved in the process of tuning the parameters for a specific application during operating conditions.

Parameter ID: 672

SETTINGS → MOTOR → MOTOR MACROS

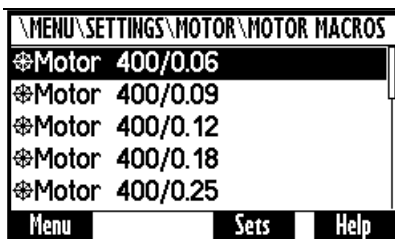

Table: Preset motor macros in frequency converters UNIFREM 400 XXX:

Motor power from 60W to 7,5kW:

Parameter name	ID	Motor type 50Hz: voltage [V] / motor power [kW]														
		400/0,06	400/0,09	400/0,12	400/0,18	400/0,25	400/0,37	400/0,55	400/0,75	400/1,1	400/1,5	400/2,2	400/3	400/4	400/5.5	400/7.5
Nominal power [W]	357	60	90	120	180	250	370	550	750	1100	1500	2200	3000	4000	5500	7500
Nominal voltage [V]	59	400	400	400	400	400	400	400	400	400	400	400	400	400	400	400
Nominal current [A]	151	0,2	0,29	0,42	0,56	0,76	1,03	1,45	1,86	2,55	3,4	4,7	6,4	8,2	11,4	15,2
Magnetizing current [A]	355	0,19	0,28	0,39	0,51	0,68	0,89	1,22	1,25	1,76	2,35	3,22	4,40	5,65	7,80	10,32
Nominal revolutions [1/min]	356	1350	1350	1350	1350	1350	1370	1395	1395	1415	1420	1420	1440	1440	1455	1455
Time constant MT [s]	79	0,05	0,052	0,0548	0,056	0,058	0,06	0,0752	0,096	0,12	0,14	0,178	0,2	0,225	0,255	0,31
Stator resistance [mΩ]	345	195000	110000	40000	36500	31000	24000	22000	18500	13175	7850	6105	4340	3400	2079,8	759,5
Rotor resistance [mΩ]	439	148200	83600	30400	27740	23560	18240	16720	14060	10013	5966	4639,8	3298,4	2584	1580,6	577,2
Leakage inductance [mH]	440	176	112	98	84	62	140	18	42	10	10	3	14	13	12	6
Mutual inductance [mH]	441	3284	2768	2002	1836	1568	1200	932	678	640	395	377	276	237	218	194
Inertia moment [kg m2]	442	0.00027	0,00027	0,0003	0,0004	0,0006	0,0008	0,0015	0,0018	0,0028	0,0035	0,0048	0,0058	0,011	0,018	0,024
Max. mot. current [A]	5	0,3	0,44	0,63	0,84	1,14	1,55	2,18	2,79	3,83	5,1	7,05	9,6	12,3	17,1	22,8
Max. regen. current [A]	549	0,3	0,44	0,63	0,84	1,14	1,55	2,18	2,79	3,83	5,1	7,05	9,6	12,3	17,1	22,8
STC Current [A]	163	0,19	0,28	0,4	0,53	0,72	0,98	1,38	1,77	2,42	3,23	4,47	6,08	7,79	10,83	14,44
Starting voltage of the V/f curve [%]	90	15,4	13,8	12,3	12,1	11,8	10,5	9,25	8,2	7,3	6,52	6,16	5,95	5,79	4,3	2,85
Max. torque [Nm]	481	1,6	2,5	3,4	3,7	3,85	4	6	10	14,8	20	29,4	40	54	74	100

Motor power from 11kW to 200kW:

Parameter name	ID	Motor type 50Hz: voltage [V] / motor power [kW]														
		400/11	400/15	400/18,5	400/22	400/30	400/37	400/45	400/55	400/75	400/90	400/100	400/110	400/132	400/160	400/200
Nominal power [W]	357	11000	15000	18500	22000	30000	37000	45000	55000	75000	90000	100000	110000	132000	160000	200000
Nominal voltage [V]	59	400	400	400	400	400	400	400	400	400	400	400	400	400	400	400
Nominal current [A]	151	21,5	28,5	35	41,5	56	68	81	100	136	160	177	198	235	280	340
Magnetizing current [A]	355	13,2	15,66	18,2	20,34	26,32	30,6	34	45,7	59,16	67,04	71,685	76,626	87,34	99,96	119,68
Nominal revolutions [1/min]	356	1460	1460	1465	1465	1465	1475	1475	1480	1485	1485	1486	1488	1488	1486	1486
Time constant MT [s]	79	0,33	0,38	0,4	0,428	0,445	0,462	0,48	0,52	0,66	0,75	0,8	0,86	0,95	1,13	1,36
Stator resistance [mΩ]	345	607,25	455	438	389	312	225	122	80	72	65	51	48	38,3	22	16
Rotor resistance [mΩ]	439	461,51	345,8	332,88	295,64	237,12	171	92,72	60,8	54,72	49,4	38,76	36,48	29,108	16,72	12,16
Leakage inductance [mH]	440	6	3	2,2	1,8	1,2	1,1	0,8	0,8	1	1,2	0,6	0,8	1,1	0,8	0,4
Mutual inductance [mH]	441	154	77	72,8	60,4	53,8	46,9	39,2	37,4	30	25,8	23,9	23	18,4	17	13,6
Inertia moment [kg m2]	442	0,04	0,052	0,099	0,117	0,191	0,374	0,447	0,688	1,19	1,39	1,63	1,94	2,31	2,88	3,46
Max. mot. current [A]	5	32,25	42,75	52,5	62,25	84	102	121,5	150	204	240	265,5	297	352,5	420	510
Max. regen. current [A]	549	32,25	42,75	52,5	62,25	84	102	121,5	150	204	240	265,5	297	352,5	420	510
STC Current [A]	163	20,425	27,075	33,25	39,425	53,2	64,6	76,95	95	129,2	152	168,15	188,1	223,25	266	323
Starting voltage of the V/f curve [%]	90	2,71	2,52	2,35	2,1	1,8	1,6	1,45	1,1	1,1	1,1	1,1	1,05	1,2	1	1
Max. torque [Nm]	481	140	200	240	284	388	482	586	710	968	1162	1288	1414	1698	2060	2560

8.3 Motor control modes

Frequency converters UNIFREM 400 can be operated in these basic control modes:

Parameter ID: 451															
SETTINGS → CONTROL AND REGULATION → CONTROL METHOD → Motor control method															
<table border="1" style="width: 100%;"> <tr> <th colspan="2">Motor control method</th> </tr> <tr> <td>V/f open</td> <td style="text-align: right;">✓</td> </tr> <tr> <td>V/f closed</td> <td></td> </tr> <tr> <td>VIM closed</td> <td></td> </tr> <tr> <td>VIM open</td> <td></td> </tr> <tr> <td>V-SMPM</td> <td></td> </tr> <tr> <td>Menu</td> <td style="text-align: right;">Help</td> </tr> </table>		Motor control method		V/f open	✓	V/f closed		VIM closed		VIM open		V-SMPM		Menu	Help
Motor control method															
V/f open	✓														
V/f closed															
VIM closed															
VIM open															
V-SMPM															
Menu	Help														
V/f open	- V/f control (scalar) without the speed feedback.														
V/f closed	- V/f control (scalar) with the speed feedback.														
VIM closed	- Dynamic vector motor control with the rotation feedback.														
VIM open.	- Dynamic vector motor control without the rotation.														
V-SMPM	- Dynamic vector motor control with the rotation feedback designed for synchronous motors.														

In the next section, we will focus mainly to functions designed for **V / F control**.

8.3.1 V/f control FREQUENCY RAMPS

Converter can use flexible ramp functions which ensure smooth transitions between different frequency setpoint values to prevent sudden step changes of the output frequency during motor control. Allowed ranges of changes of frequency (min., max.), ramp break - points and also times of the respective sections can be set by parameters of ramp functions. By using these parameters, it is possible to adapt the dynamic comfort of the drive for a specific application.

Parameters to accommodate the acceleration and deceleration ramps are in the following group:

Parameter ID: 106

SETTINGS → CONTROL AND REGULATION → FREQUENCY RAMPS

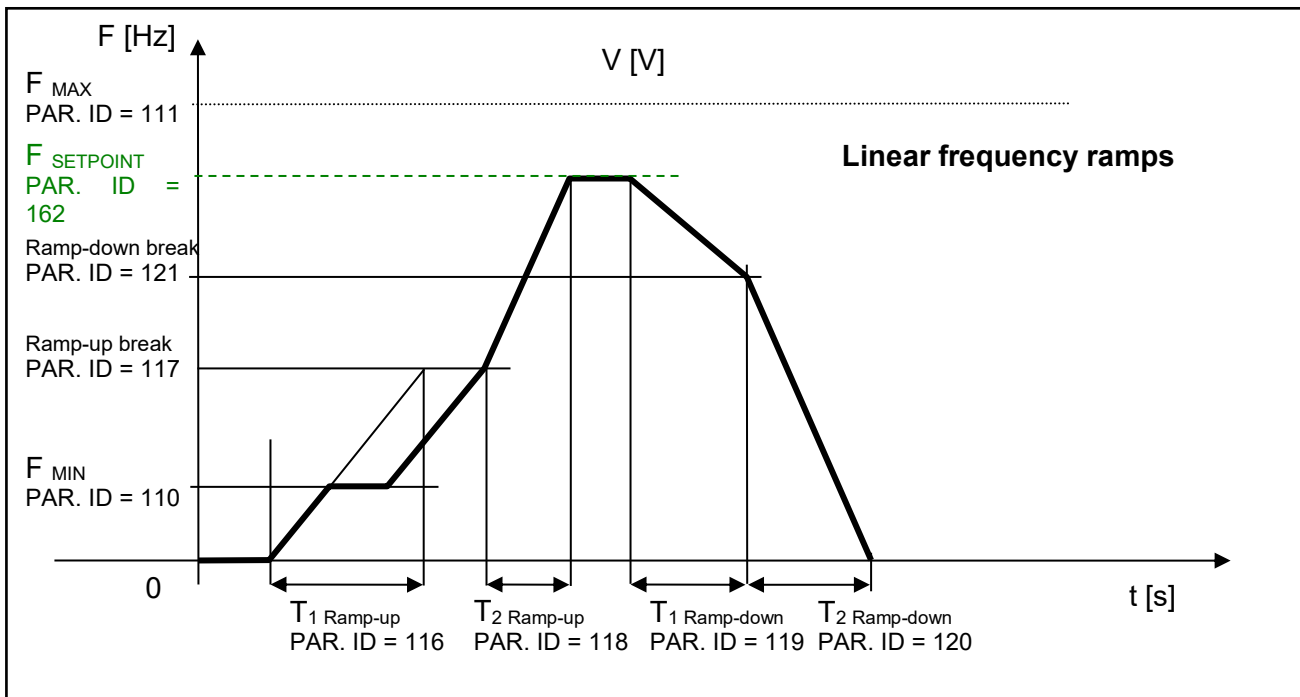

S-CURVE

If there is a demand that the acceleration should not change too quickly, it is suitable to use a S-curve that ensures smooth acceleration changes (Frequency profile is curved in the shape of S).

This is applicable to drives, where you need to minimize jerk and torque shocks during Start or Stop (e.g. passenger elevators, electric vehicles, etc.)

S-curve operation mode can be configured and modified using the parameter:

Parameter ID: 874
SETTINGS → CONTROL AND REGULATION → FREQUENCY RAMPS → S-CURVE → S-curve mode

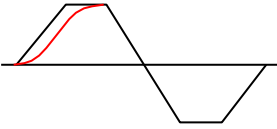
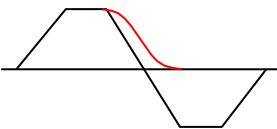
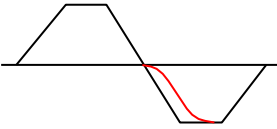
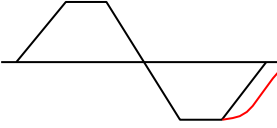
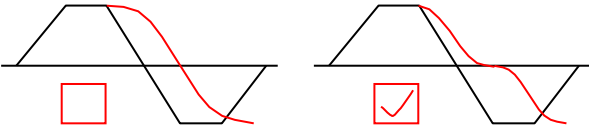
Enabling of the S-curve	<input type="checkbox"/> <input checked="" type="checkbox"/>	enabling S-curves
S-krivka ramp-up + <input type="checkbox"/>		ramp curve for positive ramp-up
S-curve ramp-down + <input type="checkbox"/>		ramp curve for positive ramp-down
S-curve ramp-up - <input type="checkbox"/>		ramp curve for negative ramp-up
S-curve ramp-down - <input type="checkbox"/>		ramp curve for negative ramp-down
S splitting <input type="checkbox"/>		zero crossing

Curve rate of the S-curve and its shape can be configured by using the parameter:

Parameter ID: 873
SETTINGS → CONTROL AND REGULATION → FREQUENCY RAMPS → S-CURVE → S-curve curvature

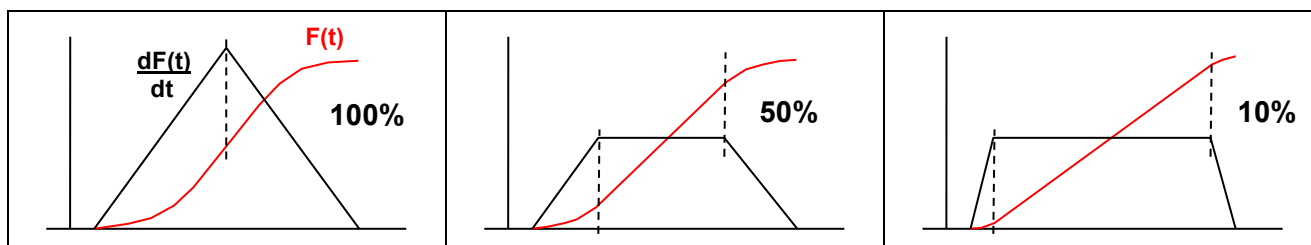

8.3.2 V/f curve

The main feature of the V/f control is that with increasing frequency of the output voltage, value of this voltage on the converter output increases proportionally until maximal value limit (saturation) is reached. The condition of induction motor constant flux is achieved by maintaining a constant ratio of **V** (voltage) / **f** (frequency).

The basis for voltage generation in scalar control mode (V/f control) is the basic V/f curve, whose parameters are:

Parameter ID: 382
SETTINGS → CONTROL AND REGULATION → V/f CONTROL → V/f curve

Parameters of the basic V/f curve:

Parameter name	ID	Description
V/f Type	34 7	V/f Curve type. Selecting the features of the V/f control method operation.
Starting voltage [%]	90	Starting voltage of the V/f curve and minimum limit of the output voltage which corresponds the percentage value of the nominal load voltage.
End voltage [%]	94	End voltage of the V/f curve which corresponds the percentage value of the nominal load voltage.
Frequency shift [Hz]	98	Frequency shift of the V/f curve.
V/f Exponent []	91	V/f curve exponent.
Exp. shift V/f	92	V/f curve shift exponent in the range from 0 Hz to Freq. shift.

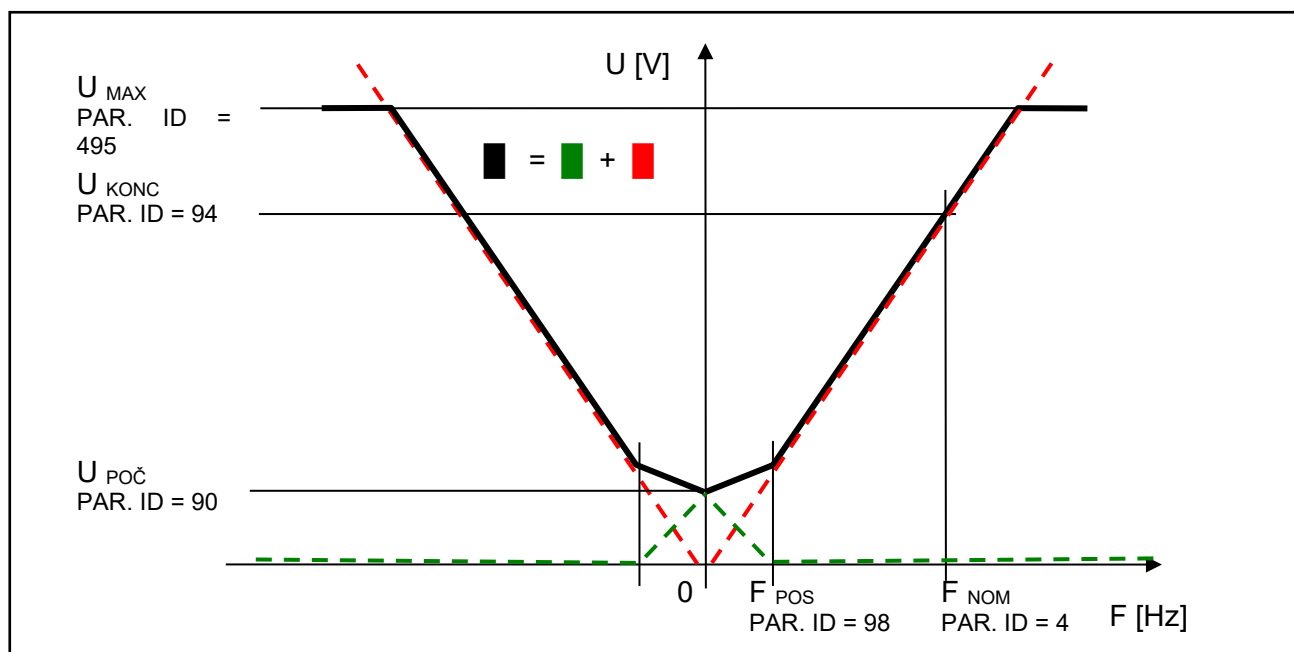

Parameters of the basic V/f CURVE

Curvature of the static V/f curve can be used for loads with a soft torque characteristics (pumps, fans) to ensure power saving motor operation on low rotation speed or to ensure a soft torque characteristics in the low rotation speed area. Smoothing of curvature is achieved by setting the exponents for individual V/f CURVE sections.

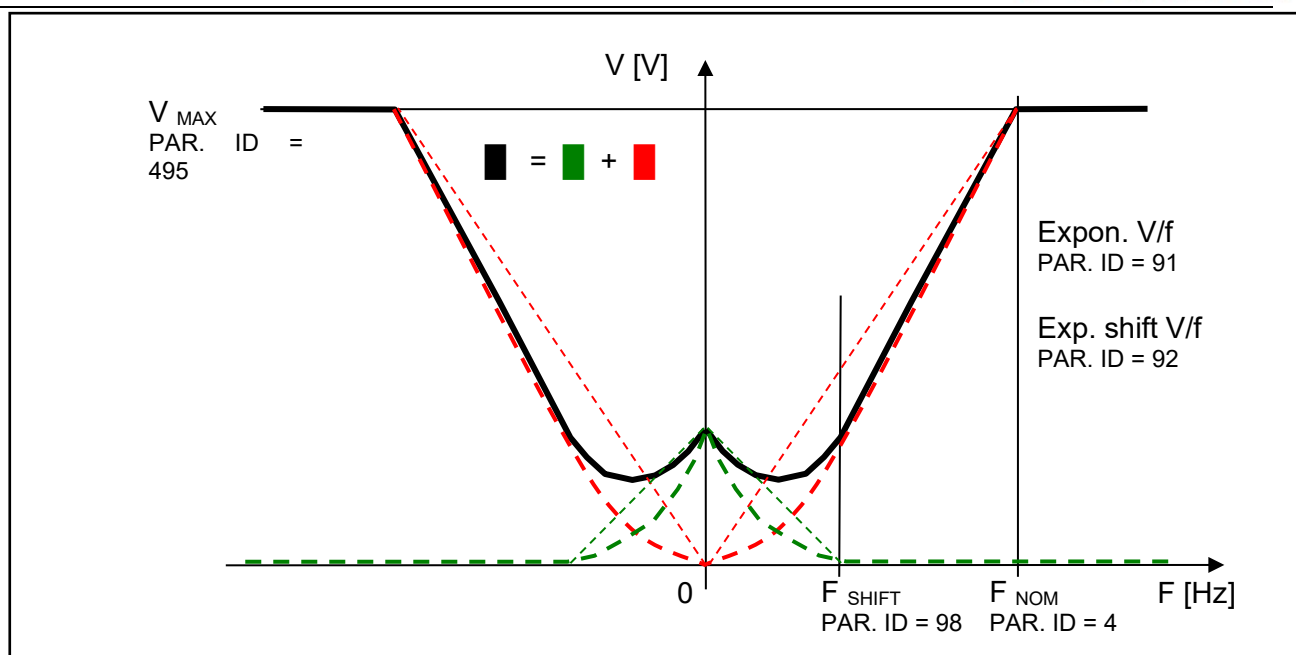

Curvatures (exponents) V/f CURVE

Basic V/f curve is a well-known and simple tool to configure the motor control.

8.3.3 IR compensation

This function can be turned on by the parameter „V/f Type (ID 347) = IR compensation“.

V/f Type	
IR compensation	<input checked="" type="checkbox"/>
ST controller	<input type="checkbox"/>

MENU \ SETTINGS \ CONTROL AND REGULATION\ V/f CONTROL \ V/f CURVE \ V/f Type -> IR compensation

The value of the output voltage is automatically corrected during active IR compensation according to the load of the drive and operating conditions. So the voltage drop in the stator windings of motor is compensated and constant motor excitation is ensured. In practice, in the motoric operation mode the voltage increases and in regenerative operation mode the voltage decreases.

Mathematical model, which is the core of IR Compensation does not reach high accuracy near zero speed, thus it is necessary to adjust the frequency from which the correction starts to apply. As a rule of thumb, it is usually 0.5 to 3 Hz. The output of correction is filtered with adjustable filter.

IR Compensation parameters:

Parameter name	ID	Description
IRC Filter	52 3	Time constant of the filter applied to the output of the IR compensation function.
IRC Frequency	79 5	Upper limit of the output frequency, in which the IR compensation is suppressed.

Prerequisite for the successful deployment of **IR Compensation** is the correct value of nominal motor parameter - Stator resistance [345].

Parameter ID: 345
SETTINGS -> MOTOR -> SPECIAL PARAMETERS -> Stator resistance [mΩ]

A good source for getting the value of this parameter is the MOTOR MACRO of the same or at least of the nearest power. From this preset value, converter will determine the exact value with automatic identification of the stator resistance, which can be turned on by the following parameter:

Parameter ID: 383
SETTINGS -> MOTOR -> SPECIAL PARAMETERS -> V/f Identification RS = Turned on

Stator resistance identification is then performed always whenever the drive is started or at zero speed operation. This can cause drive response delay to the Start motor command (ramp freeze until the resistance value settling). This condition is indicated by warning message of converter. If such behavior of the drive is unacceptable due to the operating conditions (cranes, production lines, traction ...), it is necessary to turn off identification of RS after drive tuning.

V/f Identification Rs	
Turned on	<input checked="" type="checkbox"/>
Turned off	<input type="checkbox"/>

8.3.4 Starting Torque Controller (STC)

This function can be turned on in the parameter „ V/f Type (ID 347) = ST controller “.

V/f Type	
IR compensation	<input type="checkbox"/>
ST controller	<input checked="" type="checkbox"/>

MENU \ SETTINGS \ CONTROL AND REGULATION \ V/f CONTROL \ V/f CURVE \ V/f Type -> ST controller

During activity of starting torque controller in preset frequency range, converter achieves motor excitation increase to the desired starting (engaging) current by lifting V / f curve above the basic values of V/f curve. Required dynamics of this controller must be set.

Starting Torque Controller parameters:

Parameter name	ID	Description
STC Current	163	Setpoint value of the starting torque current.
Frequency STC	28	Upper limit of the frequency area, where the starting torque controller (STC) is active.
STC Dynamics	26	Setting the ST controller dynamics.

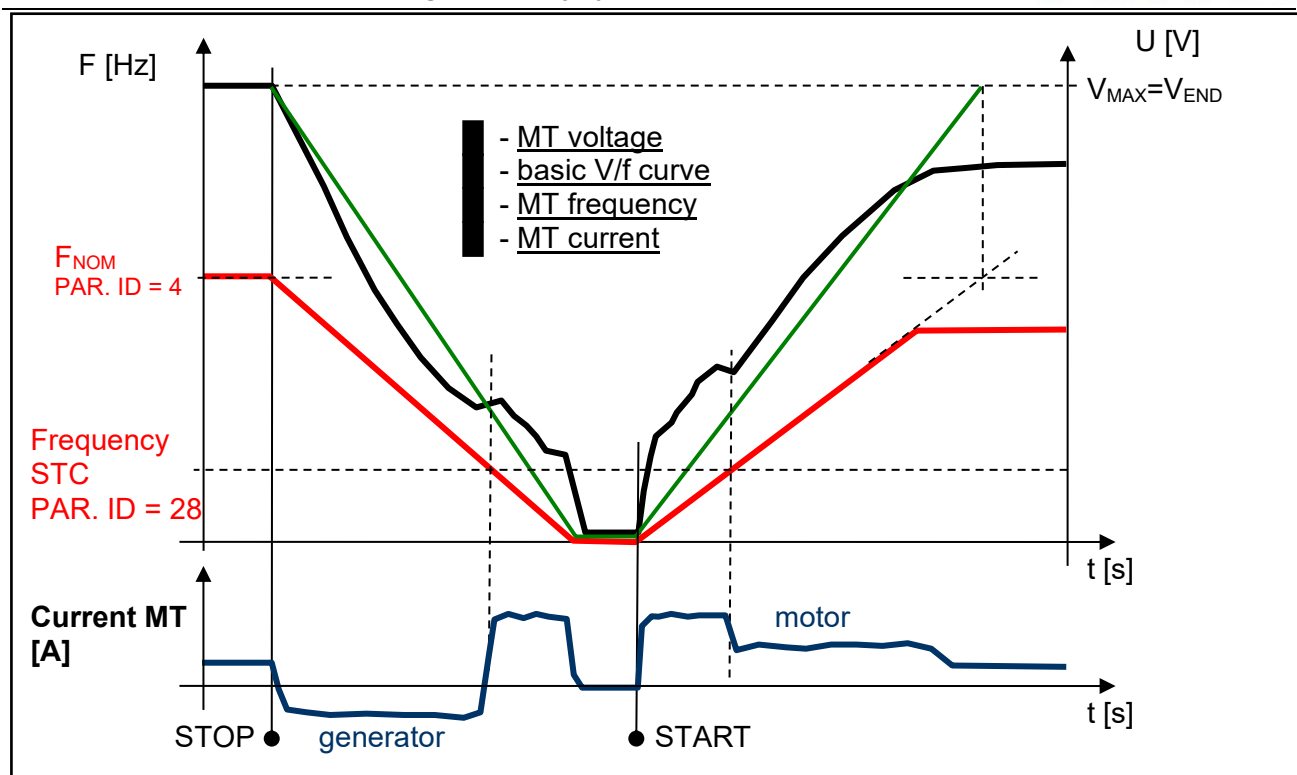

V/f curve modes on the drive with a high moment of inertia.

8.3.5 Slip compensation

Slip is the side effect of asynchronous motors operation, which means lagging / overtaking the rotor against the stator due to load. Slip as the difference of stator and rotor frequency is dependent on many factors. UNIFREM converters evaluate motor slip (slip compensation function is activated) and slip is added to the stator frequency setpoint.

Parameter ID: 349
SETTINGS -> CONTROL AND REGULATION -> V/f CONTROL -> SLIP COMPENSATION -> Slip compensation = turned on

Slip compensation	
turned off	<input type="checkbox"/>
turned on	<input checked="" type="checkbox"/>

Motor slip compensation effect: Rotor speed will maintain the value near to the setpoint value at load changes. Moreover, it greatly increases the torque capability of the motor at low speeds.

The main parameter to tune the rate of slip compensation is the gain in the parameter.

Parameter ID: 350
SETTINGS -> CONTROL AND REGULATION -> V/f CONTROL -> SLIP COMPENSATION -> Slip comp. Gain

Example: Slip compensation activity on the real drive (thin line – stator frequency, thick line – motor current).

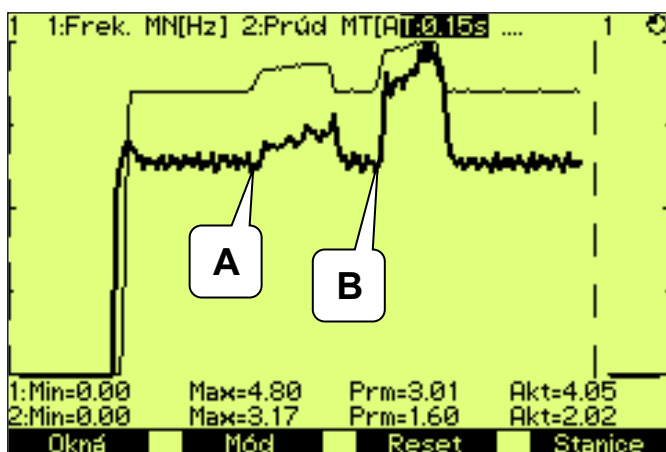

- A.** – a small load increase caused a small slip compensation.
- B.** – greater load increase caused greater slip compensation.

Model of slip for its correct operation requires proper values of motor parameter.

Parameter name	ID	Description
Nom. power [W]	357	Necessary to calculate the nominal slip.
Nom. frequency [Hz]	4	
Nom. revolutions [rpm]	356	
Stator resistance [mΩ]	345	The same conditions as for IR compensation

Slip is compensated exactly by the actual slip assessed on the difference of the stator and rotor frequency in V/f (scalar) closed control.

Parameter ID: 193

SETTINGS → CONTROL AND REGULATION → V/f CONTROL → SLIP COMPENSATION → Slip restriction = turned on

Slip restriction
turned off
turned on <input checked="" type="checkbox"/>

When this mode is enabled, converter will adjust the setpoint frequency so as not to exceed the maximum allowable slip from parameter Maximal slip [Hz] [177]:

Parameter ID: 177

SETTINGS → CONTROL AND REGULATION → V/f CONTROL → SLIP COMPENSATION → Maximal slip [Hz]

"W40-Slip restriction" warning message is generated. This state is ended after declining load on the motor and stator frequency increasing is allowed.

8.4 Maximal current controller (MCC)

Maximal current controller is a standard function of UNIFREM 400 converters, and its function is to restrict output current into the motor by correcting the output frequency. Function, as well as the controller itself, are activated in the parameter:

Parameter ID: 352

SETTINGS → CONTROL AND REGULATION → V/f CONTROL → MAX. CURRENT CONTROLLER (MCC) → Max.current contr. = motoric or = regenerative

The controller operates in motoric and regenerative operating mode.

Max. current controller	
motoric	<input checked="" type="checkbox"/>
regenerative	<input checked="" type="checkbox"/>

Frequency is decreased in motoric operating mode and increased in regenerative operating mode if current treshold is reached.

Current limit for the motor operation.

Parameter ID: 5
SETTINGS → CONTROL AND REGULATION → MAX. CURRENT CONTR. (MCC) → Max. mot. current M. [A]

Current limit for the regenerative operation.

Parameter ID: 549
SETTINGS → CONTROL AND REGULATION → MAX. CURRENT CONTR. (MCC) → Max. regen. current [A]

In specific cases, converter can adjust the restriction value according to the another criterias.

At low frequencies, the current restriction increases to the permissible overload limit in order to achieve a higher starting torque. At high frequencies the current restriction decreases to prevent motor operation in unstable part of the torque characteristics (area of power derating).

Furthermore, the „Power restriction" function can reduce the current restriction, if its conditions are met, such as high thermal integral of converter, high cooler temperature or if the conditions of power restriction are met when selecting parameter: PR Signal [1088] (signal the power is restricted according to).

The current value of the motoric restriction of the current is signalised by the diagnostic value:

Parameter ID: 494
DIAGNOSTICS → Control → Additional values → Max. current [A]

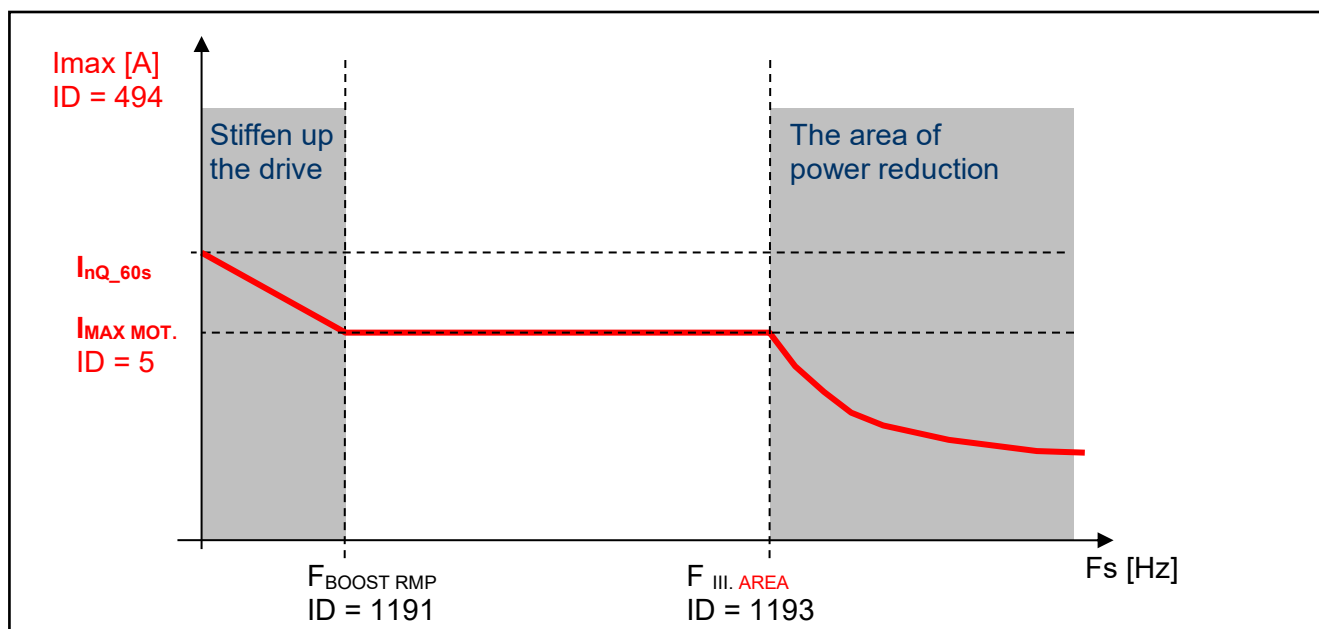

Specific cases of maximum current limit adjustment



WARNING!

In case, that the motor is loaded constantly in regenerative mode, the MCC is active and the STOP command is received, the situation can happen that the rotation speed will not decrease and the drive will not be turned off. In this case, it is necessary to increase the

value of the maximal regenerative current or generate the RESET command or interrupt the safety(emergency) input.

Parameters of the controller (P, I and D) influence the speed, the converter can restrict current with and prevent undesired current increase over allowed limit.

Parameter ID: 353
SETTINGS → CONTROL AND REGULATION → V/f CONTROL → MAX. CURRENT CONTROLLER (MCC) → P component of the MCC []

Parameter ID: 354
SETTINGS → CONTROL AND REGULATION → V/f CONTROL → MAX. CURRENT CONTROLLER (MCC) → I component of the MCC [ms ÷ s]
Parameter ID: 1047
SETTINGS → CONTROL AND REGULATION → V/f CONTROL → MAX. CURRENT CONTROLLER (MCC) → D component of the MCC []

MCC restricts the slope of frequency increase or decrease by ramps, but it can also take up during steady speed, when the current exceeds configured limits. If the frequency correction reaches frequency limit Fmin [110] or Fmax [112], it will not longer correct the frequency which will be affecting the current increase and then "Overcurrent" or "Converter overload" faults are possible. Fast correction of the starting voltage based on excessive current can be turned on to speed up the the MCC reaction and to improve operation in the low frequency range. The gain is adjusted by following parameter:

Parameter ID: 799
SETTINGS → CONTROL AND REGULATION → V/f CONTROL → MAX. CURRENT CONTROLLER (MCC) → MCC Gain []

This parameter serves to set the voltage and frequency correction of MCC:

Parameter ID: 1191
SETTINGS → CONTROL AND REGULATION → V/f CONTROL → MAX. CURRENT CONTROLLER (MCC) → Freq. boost. MCC []

Scalar (V/f) drive with current limit can be tuned by using these two parameters in order to satisfy maximal current and to keep the frequency not too low, to prevent torque lose (See. stiffen up the drive in the previous picture).

Current restriction may cooperate with slip compensation and with compensation of IR in V / f curve, as well as with other converter functions. There is a category of drives, where it is not appropriate to use MCC. These are stroke or lift drives of cranes, elevators and conveyors, where current restriction could result in the weight fall or violation to ramp speed. Then drive at high current reports generally a fault.

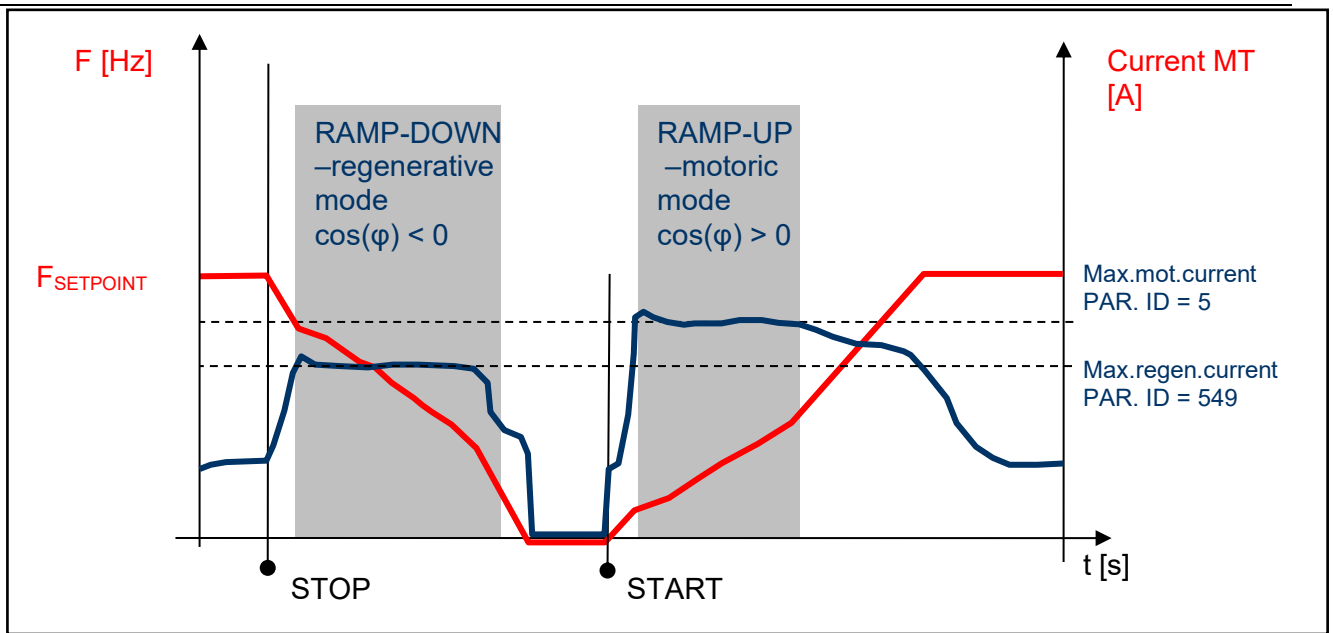

Typical current and frequency course when MCC takes up on a drive with a flywheel

Example: Current limit (MCC) takes up on a real drive:

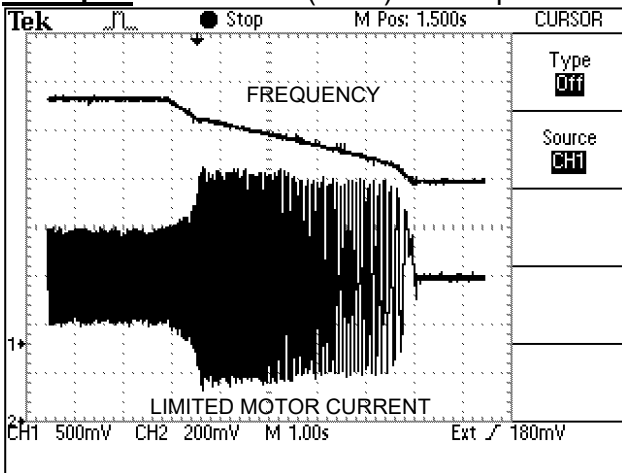

Maximal current at ramp-down, regenerative mode

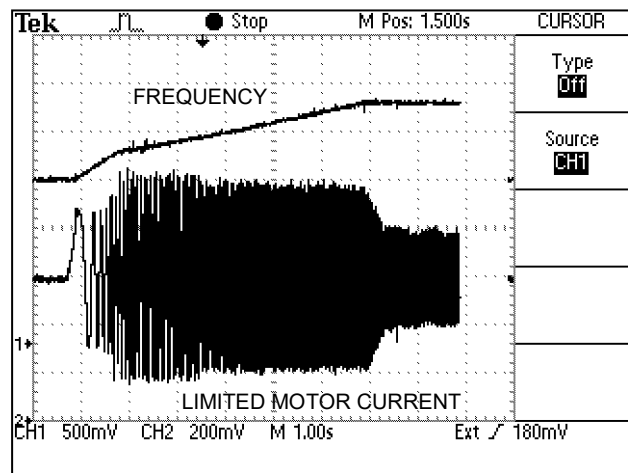

Maximal current at ramp-up, motoric mode chod

8.5 Resonance damping

Motor resonance is a phenomenon, when motor fed by the converter is vibrating and periodically moving between regenerative and motoric operating mode caused by the influence of inhomogeneity of air gap or load non-.

The period of these oscillations is usually only a few periods of the stator frequency. Resonance results in a vibration of mechanical parts, increasing their stress and vibration in the DC link voltage, motor current, and subsequent failures.

Example: Resonant oscillations are measured on a traction drive (sky-blue – DC link voltage, yellow – current in one of motor phases)

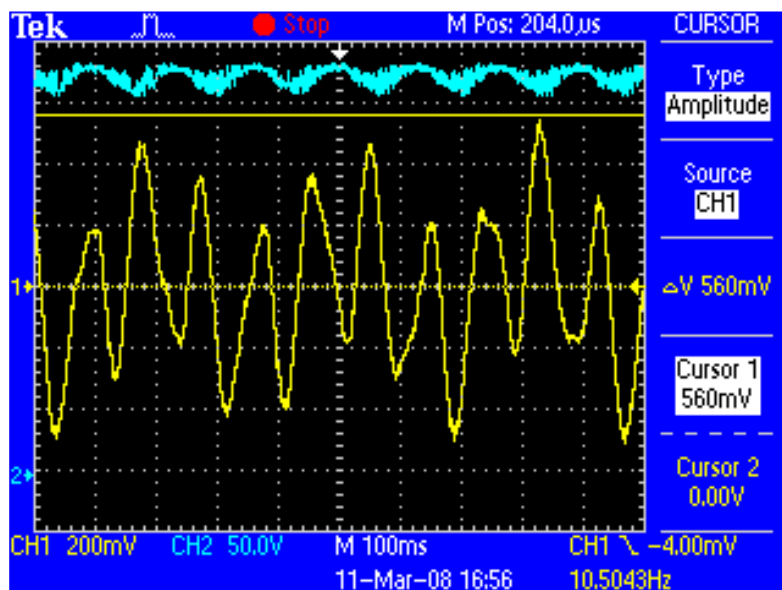

Resonance damping function can be turned on and off by parameter:

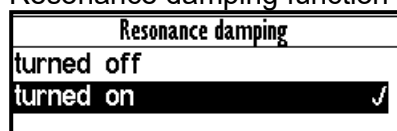

Parameter ID: 513
SETTINGS → CONTROL AND REGULATION → V/f CONTROL → RESONANCE DAMPING → Resonance damping = turn on

To adjust the damping, three coefficients that govern the degree of influence of selected process variables on the output frequency and voltage are used. Oscillations amplitude can be reduced or even completely removed by suitable tuning of these parameters.

Parameter ID: 514	Setting the resonance damping gain of the derivative DC voltage resonance
SETTINGS → CONTROL AND REGULATION → V/f CONTROL → RESONANCE DAMPING → Effect from the dVdc []	
Parameter ID: 515	Setting the resonance damping gain of the derivative stator current model.
SETTINGS → CONTROL AND REGULATION → V/f CONTROL → RESONANCE DAMPING → Effect from the dIs []	
Parameter ID: 516	Setting the resonance damping gain from the stator current frequency change.
SETTINGS → CONTROL AND REGULATION → V/f CONTROL → RESONANCE DAMPING → Effect from the dwIs []	

UNIFREM v.5.20x

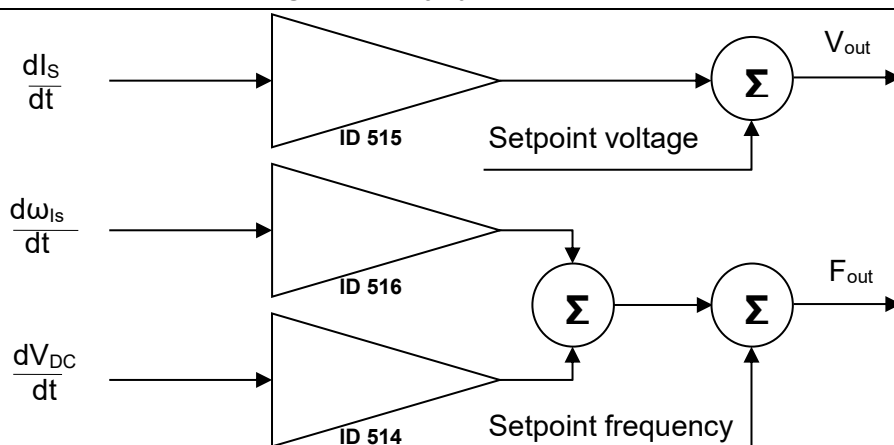

Importance of function coefficients „Resonance damping“

Resonance damping can reduce or completely suppress undesired motor vibration, especially if there is a small load operation.

8.6 Voltage controller (VC) - Dynamic deceleration (DD) a Kinetic backup (KB).

DC-link voltage (V_{DC}) is the one of the most important parameters of frequency converter. Its value is equal to the peak value of the rectified AC phase to phase voltage ($U_{DC} = 1.414 * U_{UV}$) under normal conditions. For 400V power supply network this value is around 565V. DC link voltage can therefore vary with the grid voltage. If motor is under load at large voltage drop of power supply network, motor will not get enough voltage, which causes its deexcitation, slip and load current increasing. It is necessary to reduce the frequency to a value when there is sufficient voltage on motor at lower grid voltage, if we want to prevent overheating of the motor and converter or unwanted fault "Overcurrent". Block "**Voltage controller**" and its part **kinetic backup controller (KBC)** are made for these cases in UNIFREM 400 XXX frequency converters. Among other things, it also serves to bypass short-term supply network outages, when the required minimum voltage U_{DC} is maintained with controlled setpoint frequency reduction and by mass inertia braking.

V_{DC} voltage rises due to spillover of the energy from the motor back to the converter during motor braking, thus at ramp-down or under the influence of external forces to the motor. In this case the converter has sufficient voltage to correct motor control, but the voltage stress of the power components increases and there is risk of "overvoltage" fault. Braking resistors and modules that convert the excess energy into the heat are generally used to limit the V_{DC} at drives, where motor works mainly in the regenerative operation mode (strokes of cranes, lifts, rapid ramp-up / ramp-down of inertia). It is possible to use the second part of the section "**Voltage controller**" - **Dynamic deceleration controller (DDC)**, where it is not strictly prescribed the stopping time of the drive. Dynamic deceleration controller will stop growth of the DC voltage with the setpoint frequency increasing. Controller will stop to correct it at the frequency maximum and will allow voltage increasing to the fault level (the same is true even in current limit - MCC).

Each part of the **Voltage controller** can be independently turned on / off by parameters:

Parameter ID: 748

SETTINGS -> CONTROL AND REGULATION -> VOLTAGE CONTROLLER (VC) -> Kinetic backup (KB)

Kinetic backup (KB)	
turned off	
turned on	<input checked="" type="checkbox"/>

Parameter ID: 749
 SETTINGS → CONTROL AND REGULATION → VOLTAGE CONTROLLER (VC) → Dynamic deceleration (DD)

Dynamic deceleration (DD)	
turned off	
turned on	<input checked="" type="checkbox"/>

The important parameters of voltage controller are reference values of DC link at which the function of the kinetic backup and dynamic deceleration is activated.

Parameter ID: 753
 SETTINGS → CONTROL AND REGULATION → VOLTAGE CONTROLLER (VC) → KB setpoint

Parameter ID: 754
 SETTINGS → CONTROL AND REGULATION → VOLTAGE CONTROLLER (VC) → DD setpoint

Voltage controller components P, I and D, which together affect the KBC and DDC are used to adjust the dynamic of response and possible tuning of voltage overshoot or to stabilize the oscillating waveform.

Parameter ID: 751
 SETTINGS → CONTROL AND REGULATION → VOLTAGE CONTROLLER (VC) → P gain VC

Parameter ID: 752
 SETTINGS → CONTROL AND REGULATION → VOLTAGE CONTROLLER (VC) → I gain VC

Parameter ID: 750
 SETTINGS → CONTROL AND REGULATION → VOLTAGE CONTROLLER (VC) → D gain VC

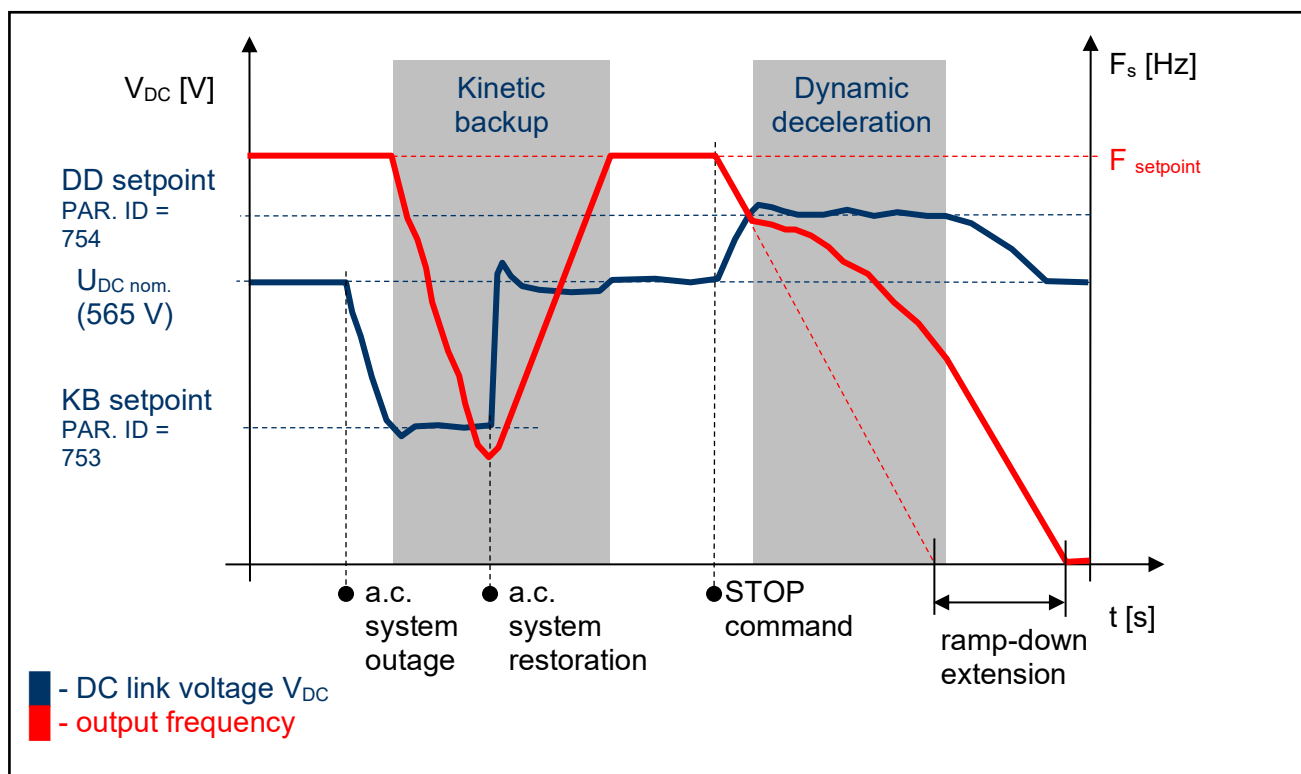

Voltage controller (VR) - principle of operation

Example: Measurement results of VC deployment on the drive with flywheel.

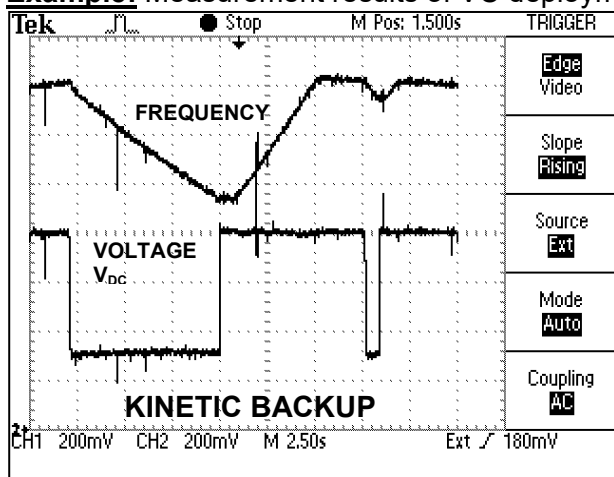

Kinetic backup of converter at power supply voltage failure on the motor with flywheel.

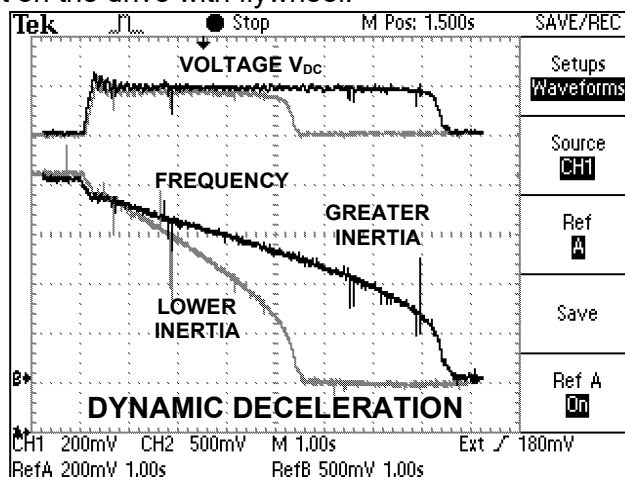

Dynamic deceleration at different inertias of the drive.

In many industrial applications of the drives with frequency converters it is required to stop the drive in the shortest time. This significantly reduces the cycle time of repeated working cycles and has a direct impact on production productivity. In addition, if it is a drive, where moment of inertia and loading ratios are variable, fixed time of ramp-down setting can be problem. Then is necessary to apply dynamic deceleration mode. For example, spin-driers, mills, blenders, where inertia depends on the amount of processed material.

8.7 Flux braking

Several braking modes can be used in frequency converters. Mainly it is the use of a braking module and a braking resistor. However, there are drives, where braking conditions occur partly and not often. For example, if it is needed to stop the pump in 10 seconds, but during the ramp-down an "Overvoltage" fault occurs, it is not necessary to use the braking module. If for example 13 or 15 second long ramp-down ends without a fault, the amount of generated energy can be decreased by using the **Flux braking function**.

To activate the function - flux braking use this parameter:

Parameter ID: 775
SETTINGS → CONTROL AND REGULATION → FLUX BRAKING → Flux braking (FB)

Flux braking (FB)
turned off
turned on <input checked="" type="checkbox"/>

It works as follows: the converter starts to increase the motor voltage after exceeding the "FB working voltage", and excitation (flux) is increased. This causes that a part of the energy is not flowing from the motor to the converter, but it is transformed to heat in the motor coil. Increasing the flux braking rate is possible by using the parameter "Flux braking gain [777]".

Parameter ID: 776
SETTINGS → COTROL AND REGULATION → FLUX BRAKING → Operating voltage FB [V]
Parameter ID: 777
SETTINGS → COTROL AND REGULATION → FLUX BRAKING → Flux braking gain []

Example: Activity of flux braking on the real device

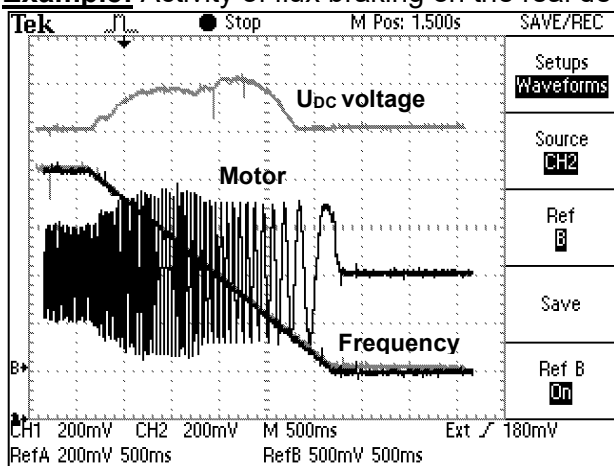

Flux braking at lower gain

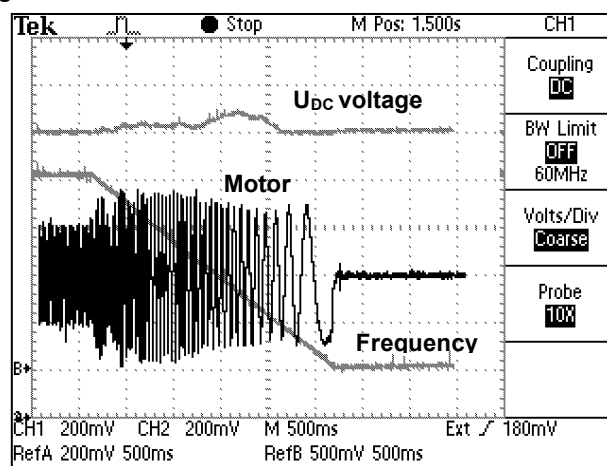

Flux braking at higher gain

During flux braking, bigger motor overheating occurs, so it is necessary to provide sufficient thermal protection, thermistor or PT100, possibly forced cooling.

8.8 Flying start

During the operation of electric drives there is often a situation, when you need to start control, even if the motor is rotating. For example: flue fan is rotating due to pressure difference, traction vehicle is in motion or generator of small hydropower plant is rotating. The most accurate and fastest process to do this is by using the speed sensor (encoder-IRC). Encoder gives precise information about the frequency of the machine and the converter is able to automatically adapt and phase-on. It is not necessary to use the sensor when using the function "Flying start" in the frequency converter UNIFREM 400 XXX. Flying start can be turned on by parameter:

Parameter ID: 374

SETTINGS → CONTROL AND REGULATION → FLYING START → Flying start

Flying start	
Turned off	
Accelerated	
Normal	✓

It is a fully automatic function which carries out the process off flying start to the rotating motor (or generator) always after the START command activating. Flying start takes place in several stages and its duration may be variable from rotational speed, motor power as well as parameter settings.

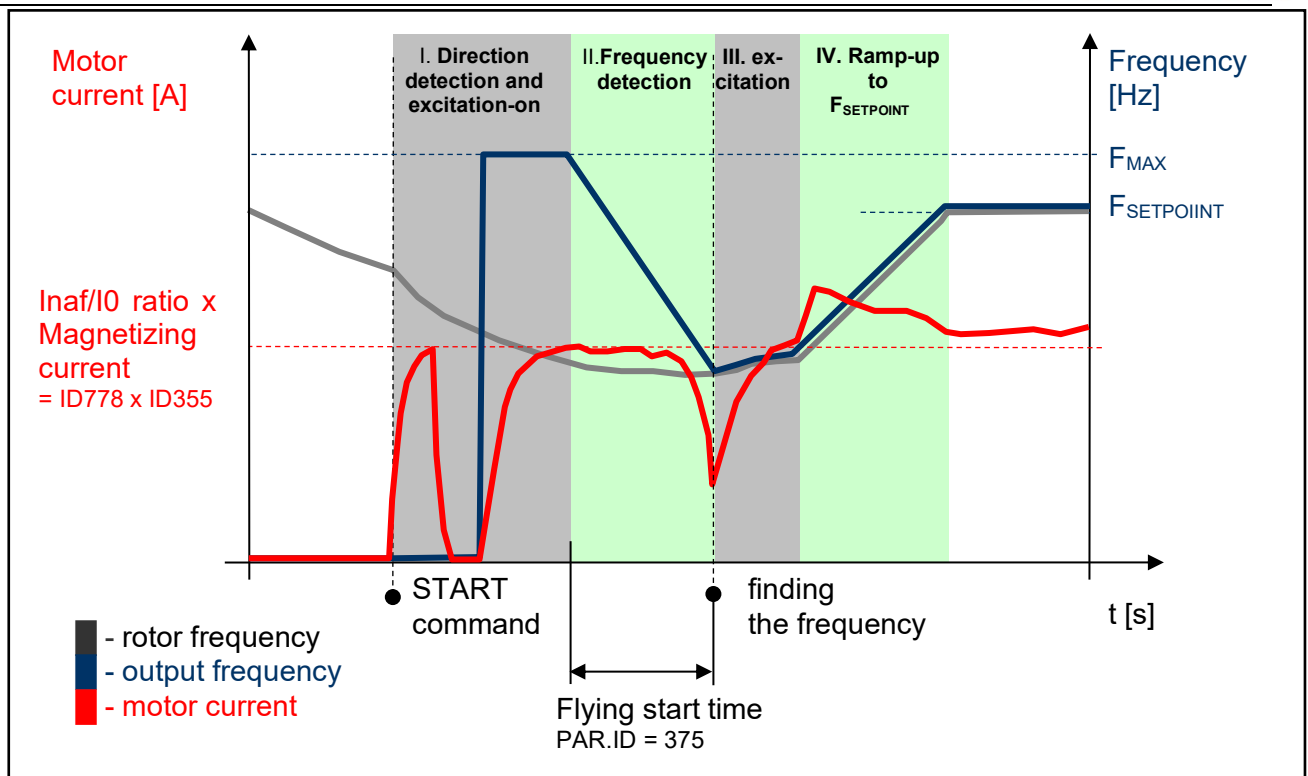

Flying start – principles of operation

Success of flying start and search time is dependent on the following parameters:

(Multiple of magnetization current – it affects the sensitivity of the flying start and intensity of rotor braking)

Parameter ID: 778
SETTINGS → CONTROL AND REGULATION → FLYING START → Inaf/I0 Ratio []

(Time constant MT – affects the speed of motor excitation)

Parameter ID: 79
SETTINGS → MOTOR → SPECIAL PARAMETERS → Time constant MT [s]

Example: Flying start to rotating motor

(thin line - output frequency, thick line - motor current, red dotted line - the rotor frequency)

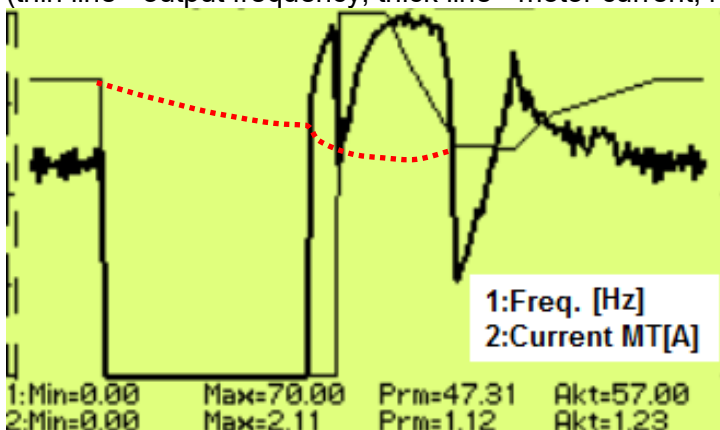

8.9 Power restriction

In a real environment, the need to keep the drive in operating mode even if the motor or the converter is overloaded can occur. Possible fault caused by overloading or overheating should cause outage of the technology, which could be worse than an eventual short term decrease of the

motor power. Because of this, UNIFREM 400 XXX frequency converters have a power restriction functional block in their software equipment.

Power restriction function is configured in the parameter:

Parameter ID: 766
SETTINGS -> CONTROL AND REGULATION -> Power restriction []

There it is possible to activate individual sources (causes) of the power restriction or their combinations:

Power restriction (PR)	
from overload	<input checked="" type="checkbox"/>
from the cooler temperat..	<input checked="" type="checkbox"/>
from the motor overload	<input checked="" type="checkbox"/>
from external temperature	<input type="checkbox"/>
from the power restrictio..	<input checked="" type="checkbox"/>

From overload	Thermal integral INV (ID 31) > 90 %	Fault = 100 %
From cooler temp.	Cooler temp. (ID 74) > C_temp warning (ID 767)	Fault = 90 °C
From motor overload	Temp integral MT (ID 33) > 90 %	Fault = 100 %
From external temp.	ETP Temp. (ID 869) > ETP Warning (ID 865)	Fault = ID 866
From the power restriction signal	P[1088]) PR Signal beyond the value P[1089] PR signal limit.	

When warnings from the external thermal protection of the converter (motor) occur, power restriction is activated. Power restriction output is the correction of the maximal current so the corresponding displayed status values do not exceed fault level and converter operation does not stop. Power restriction is executed by restricting the maximal current. The maximal current controller (MCC) has to be activated and functional (ID 352).

Example: Power restriction operation from the converter overload of an undersized drive with an induction motor
(thin line - Thermal. integral. INV, thick line – Current MT).

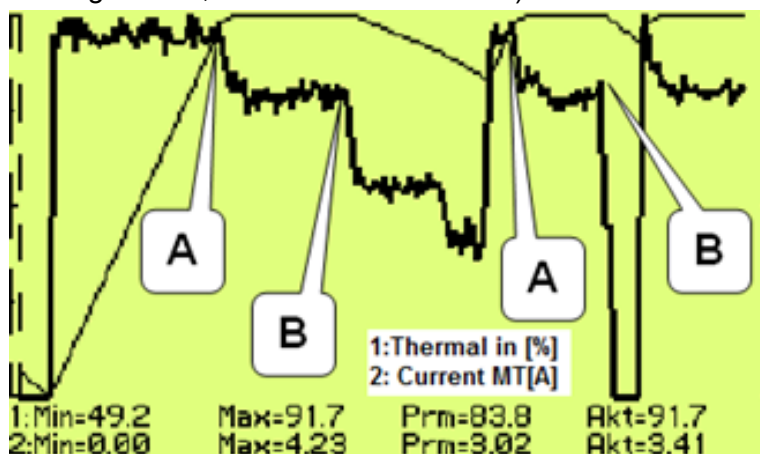

A – Drive was running under full load, temperature integral of the converter reached 90% level and then restricted the current so the integral will not increase further.

B – Drive was relieved and the integral is decreasing. The drive is capable to generate maximal power again.

8.10 Optimization

Optimization is an individual management and control block and its goal is to ensure searching and maintaining optimal values of any displayed value or parameter of the converter by using an input

channel. Optimization has its own output, which operates in the interval 0.000 to 1.000 and it is possible to display it in the converter diagnostics:

Parameter ID: 423
DIAGNOSTICS → Functions → Optimization → OPT Output []

The optimization output connection to any entering channel is performed after selecting this parameter by selecting the signal (source) of the corresponding entering channel.

Value selection, which criteria should be searched by the optimization block is performed by parameter configuration:

Parameter ID: 80
SETTINGS → FUNCTIONS → OPTIMIZATION → Optimization signal

Signal selection	
\MENU\DIAGNOSTICS\Control	
-Slip freq.	0.00 Hz
-Rpm	0 RPM
-Voltage DC	318.5 V
-Voltage MT	0.0 V
-Current MT	0.00 A

Motor current, motor power and motor torque are selected as the optimization signal in standard optimization tasks mostly. After selecting one of the analog inputs, it is possible to optimize any technological value.

Optimization criteria defines, if converter will search for the minimum or the maximum of the selected signal. For example on generator drive of hydro power-plant, if we want to maximize the produced power and minimize the power losses on a pump drive.

Opt. criteria	
Signal min.	
Signal max.	<input checked="" type="checkbox"/>

To select the criteria, use the parameter:

Parameter ID: 208
SETTINGS → FUNCTIONS → OPTIMIZATION → Optimization criteria

Blocking (reset) the optimization and measurement condition:

Two signals are in the OPTIMIZATION block, that control the optimization operation conditions and a condition, when it is possible to measure optimized values.

To configure the conditions for blocking and resetting the optimization, use the signal:

Parameter ID: 263
SETTINGS → FUNCTIONS → OPTIMIZATION → Opt. Reset signal

Signal selection	
\MENU\DIAGNOSTICS\Converter state	
-MT operational hours	44.3 h
-Converter state	---■--■--■
-Converter state negated	■■■-■-■-■
-Warning	0x0
-Warning 2	0x0

For example: If the optimization is set to search for maximal or minimal power, it is necessary to block its operation when the device is turned off. Then the parameter „Opt. reset signal“ [263] is set to the value Converter status negated (negation of the status word) and the command Run (converter generates the output voltage) is set in the parameter „Opt. Reset“ [273] concurrently.

Opt. reset	
Error	<input type="checkbox"/>
SW_Err_Pin	<input type="checkbox"/>
Operation	<input checked="" type="checkbox"/>
DC charged	<input type="checkbox"/>
MT excited	<input type="checkbox"/>

Since the status word is **negated**, it means that, optimization Reset is active when the converter does not generate the output voltage.

When the optimization output change causes transiting effects which duration period is variable, it is necessary to delay measuring optimization criteria. Signal from the following parameter is used to configure measurement conditions:

Parameter ID: 279
SETTINGS -> FUNCTIONS -> OPTIMIZATION -> Opt. meas. signal

If the measurement should be executed after the ramp function ends, in this signal the value **Converter status negated** (negation of the status word) is selected again and the bit "Accel/Decel. F" is set in the parameter **Opt. meas. turns on [160]**. This means, that after the optimization output change, the process is waiting for the ramp function to settle and then a new measurement for the next optimization step is performed.

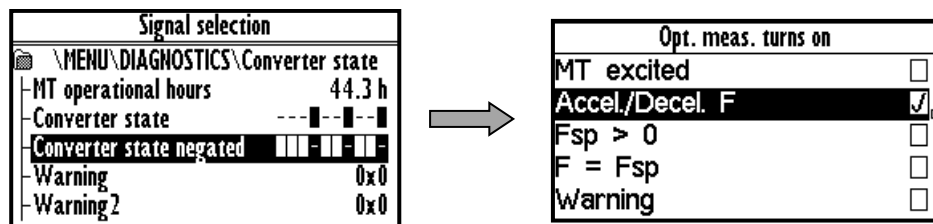

To adjust and configure the optimization process, use following parameters:

Parameter name	ID	Description
Optimization period	13	Measuring period of one step of the optimization algorithm. Time between individual steps can be extended by the measurement condition (see "Opt. Measurement signal [279]").
Scan	420	Activate/Deactivate the scan mode of the optimization output when starting the optimization. It is used to find the starting value of the optimization output. It searches for the global extremum from multiple possible extremes by searching the whole range by a maximal step of 0.05.
delta Sign.	255	Defines the value of the maximal allowed variance of the actual value "Optim. Signal [80]" from the global extreme. Global extremum is getting closer to the actual output value from the optimization (scan) start, which follows the slow changes of the global extremes. After deflecting the output from the global extremum by the defined value of "delta Sign." a new scan is performed, if it is activated.
Step mode	425	Defines, if the change size of the optimization between two steps should be solid or variable. Variable step means, that the step size is based on the adaptivity from the "Optim. Signal [80]" derivation.
Minim. step	427	Minimal or solid optimization output change between two steps.
Adapt. step gain	743	Defines the intensity of the "Optim. Signal [80]" derivation effect on the optimization step increase, if the "Step mode" is activated and "variable" is set.
First direction	426	Sets the starting direction of the optimization from start, if it should search for output changes up from 0.00 ("from minimum") or down from 1.00 ("from maximum").

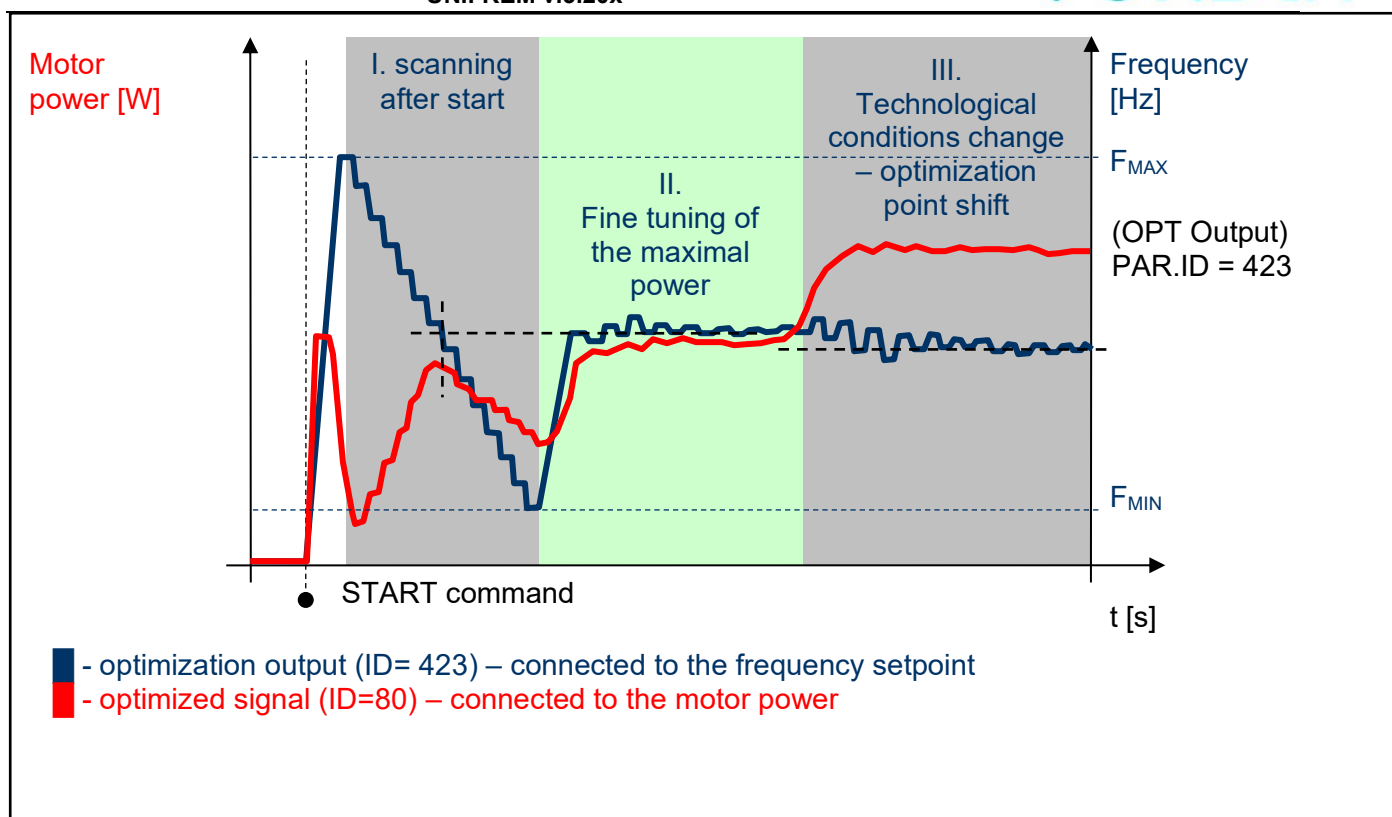

Optimization – principle of the operation by maximizing the power using frequency

Example: Optimization operation on the drive (thick line - OPT. Output, thin line - Power drain). In this case, the Start Direction (ID = 426) is set to "From maximum".

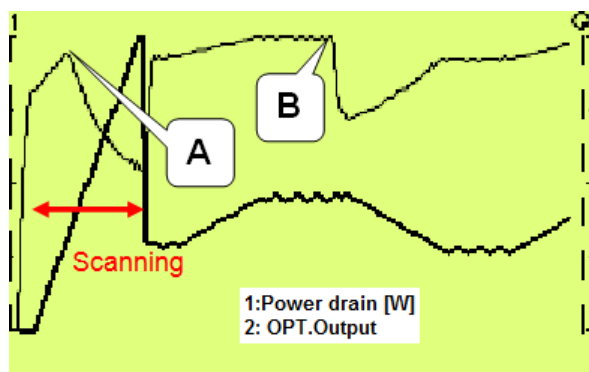

A – Optimization starting point found by scanning. It will be configured accurately later during fine tuning.

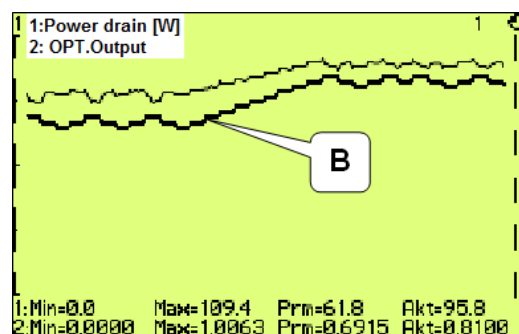

B – Technological conditions change – optimization output settling and finding the new optimum point.

8.11 External thermal protection (ETP)

If there is a temperature sensor or system of multiple sensors of the same type on the device, of which the frequency converter is a part, it is possible to connect these sensors into the converter and evaluate the device temperature and if needed, generate warning or fault. ETP block parameters can be found in:

Parameter ID: 860

SETTINGS → FUNCTIONS → EXTERNAL THERMAL PROTECTION (ETP)

One free analog input and output are used to connect the temperature sensors. Mathematical model calculates the optimal "ETP Current", which will be selected as a signal of the corresponding AOUTx. Voltage drop occurs on AINx, AINx writes it into the

parameter **"ETP Voltage"**. Sensor resistance and then temperature are evaluated from this data. After exceeding the warning or fault limit, ETP temperature warning or fault is generated.

Meaning of the parameters and their logical connection is explained in the following picture.

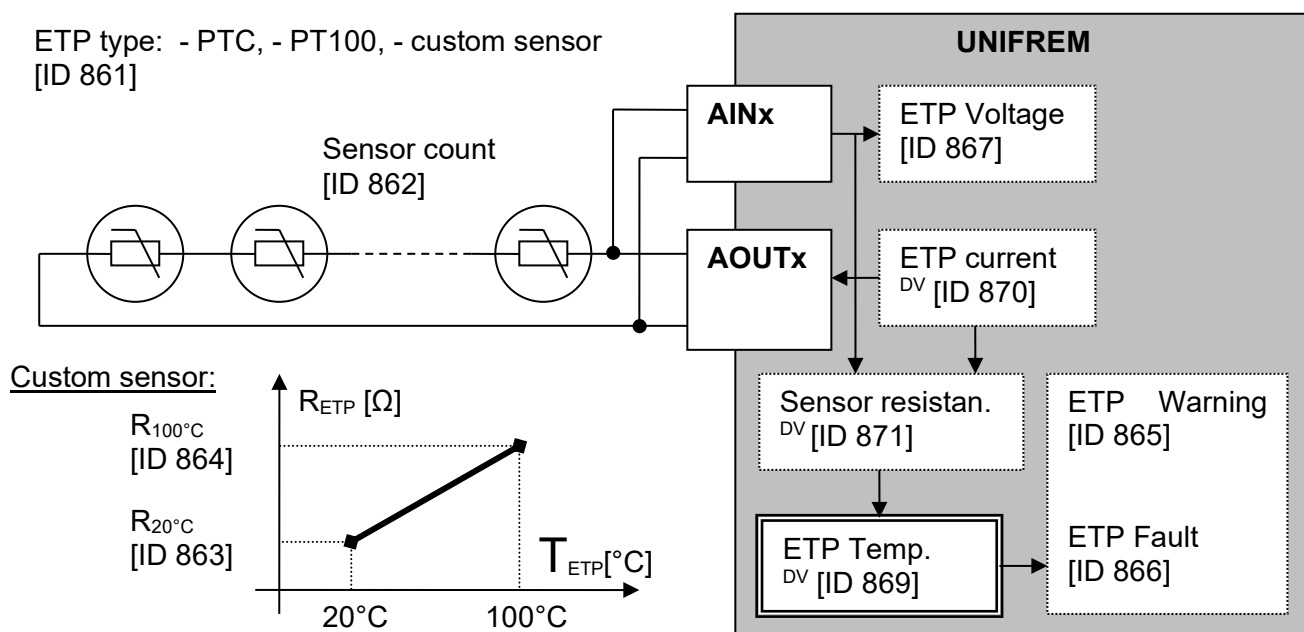

One analog input (free) and one analog output (free) of the X1 terminal of UNIFREM processor board can be used to connect the sensor.

ETP setting example – 3 x PTC sensor types connected in series:

PART SETTINGS:

PTC sensor setting:

[ID]	Path	Parameter	Setting
861	MENU \ SETTINGS \ FUNCTIONS \ EXTERNAL THERMAL PROTECTION (ETP) \	ETP Type	PTC thermistor
906	MENU \ SETTINGS \ FUNCTIONS \ EXTERNAL THERMAL PROTECTION (ETP) \	Voltage source ETP	AIN2
862	MENU \ SETTINGS \ FUNCTIONS \ EXTERNAL THERMAL PROTECTION (ETP) \	Sensor count	3

Example of setting – ETP warning and fault lines derived from the parameters:

865	MENU \ SETTINGS \ FUNCTIONS \ EXTERNAL THERMAL PROTECTION (ETP) \	ETP Warning	90°C
866	MENU \ SETTINGS \ FUNCTIONS \ EXTERNAL THERMAL PROTECTION (ETP) \	ETP Fault	160.0 °C

ETP maximal current restriction:

Parameter **ETP maximal current (ID 1087)** restricts the current to the EHP sensors to prevent undesired overheating of the sensor. If a special sensor is used, it is necessary to set the maximal current according to its specification. In the EHP = PTC type, the measuring current is limited to the 1mA value and in the PT100 type to 3mA and then this parameter is inactive.

1087	MENU \ SETTINGS \ FUNCTIONS \ EXTERNAL THERMAL PROTECTION (ETP) \	ETP maximal current	10.00 mA
------	---	---------------------	----------

Analog input AIN2 setting:

[ID]	Cesta	Parameter	Setting
154	MENU \ SETTINGS \ INPUTS AND OUTPUTS \ ANALOG INPUTS \ AIN2 \	AIN2 Type	0-10V

The option of noise filtering on the analog input:

262	MENU \ SETTINGS \ INPUTS AND OUTPUTS \ ANALOG INPUTS \ AIN2 \	AIN2 Filter	1s
-----	---	-------------	----

Analog output AOUT2 setting:

[ID]	Path	Parameter	Setting
362	MENU \ SETTINGS \ INPUTS AND OUTPUTS \ ANALOG OUTPUTS \ AO2 \	AO2 Type	0-20mA
1077	MENU \ SETTINGS \ INPUTS AND OUTPUTS \ ANALOG OUTPUTS \ AO2 \	AO2 Source	ETP Current
366	MENU \ SETTINGS \ INPUTS AND OUTPUTS \ ANALOG OUTPUTS \ AO2 \	Sig. (AO2_A)	0 mA
368	MENU \ SETTINGS \ INPUTS AND OUTPUTS \ ANALOG OUTPUTS \ AO2 \	Sig. (AO2_B)	20 mA
945	MENU \ SETTINGS \ INPUTS AND OUTPUTS \ ANALOG OUTPUTS \ AO2 \	AO2_A	0 mA
946	MENU \ SETTINGS \ INPUTS AND OUTPUTS \ ANALOG OUTPUTS \ AO2 \	AO2_B	20 mA

ETP DIAGNOSTICS:

The possibility of checking the measured data:

[ID]	Path	Parameter	Description
869	MENU \ DIAGNOSTICS \ Functions \ Ext. thermal protection \	ETP Temperature [°C]	Temperature of the ETP sensor.
870	MENU \ DIAGNOSTICS \ Functions \ Ext. thermal protection \	ETP Current [mA]	Measuring current of the external thermal protection.
867	MENU \ DIAGNOSTICS \ Functions \ Ext. thermal protection \	ETP Voltage [V]	Value of measured voltage drop on the ETP sensor.
871	MENU \ DIAGNOSTICS \ Functions \ Ext. thermal protection \	Sensor rezistance [Ω]	Resistance value of the ETP sensor.

8.12 Overload switch „OPS“

For the evaluation of the maximum load of the construction or technological line, various devices are used especially in lift drives of cranes, but also in other areas of frequency converters deployment. Frequency converters UNIFREM can evaluate the load of the drive by measuring the electrical parameters (Displayed value - Load) and carry out the necessary changes in the behavior of the drive, so that the operation of the drive will be safe. „OPS“ can be used for example for stroke drives of cranes, shifts at cutting, drilling and supports of machine tools. A new conception of overload switch in UNIFREM frequency converters includes several improvements and innovations.

Terms:

Load – It is an optional quantity, which represents a measure of the drive load. Motor torque, motor current, Power or even AINx can be generally chosen, if load evaluation is external.

Overload – It is the drive status when the conditions of the drive overload are fulfilled. STOP can be generated automatically, speed can be limited, or it can be signalized on the converter outputs.

Dynamic operation – It is the working status of the drive when accelerating in the positive direction, when the drive overcomes the resistance of inertia mass and Coulomb friction except static load.

Static operation – It is the working status of the drive during steady-state speed in the positive direction.

Short commands count – It is a sequence of control commands, which bypasses the conditions of formation of overload. For example, short commands START or intermittent acceleration.

The following parameters are used to configure the overload switch:

Parameter ID: 840
SETTINGS -> FUNCTIONS -> LIFTING FUNCTIONS -> OPS

Configuration and mode of operation:

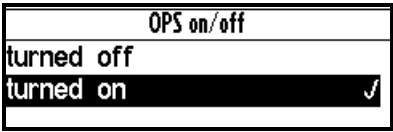
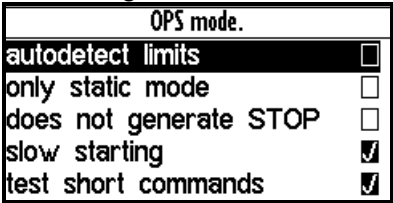
Parameter name	ID	Description
OPS on/off	841	Activation or deactivation of the electronic OPS switch function. 
OPS mode	842	Activating the overload switch modes. 

The method of calculating the value „Load“: Lifting functions

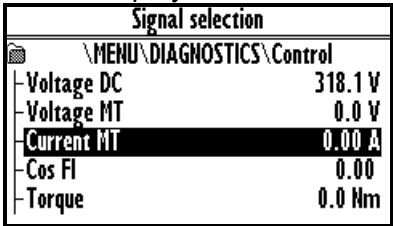
Load. signal	843	Selection of the parameter, that will be used as calculation source for the displayed value „Overload“.  <p><i>Example of variable selection, which is a measure of the drive load.</i></p>
100% Load	844	It is used to conversion to relative units. Value of the selected load signal (ID 843) that equals 100% of the load.
Load filter	851	First row filter, that is used for noise or short peaks of the selected load signal (ID 843) reduction.

Conditions of "Overload" appearance and disappearance:

Time after the start	852	Insensitivity period of the OPS after the drive start.
Dynamic overload	845	Drive overload limit in dynamic states (when accelerating in positive direction).
Dynamic overload period	848	Period during which the load value has to be higher than the dynamic overload limit, so the overload switch will switch on.
Static overload	846	Drive overload limit in static states (at a constant speed in a positive direction).
Static overload period	849	Period during which the load value has to be higher than the static overload limit, so the overload switch will switch on.
Overload turn off	847	Load limit to end the Overload in the backward movement at constant speed.
Overload period turn on	850	Period during which the load value has to be lower than the overload stop limit, so the overload switch will switch off.

Blocking signal of „Overload“:

OPS reset source	572	This command blocks or switches off the OPS switch. Numeric or bit signal can be selected.
OPS reset	858	The OPS reset command will be active if at least one of the selected binary inputs or logical blocks will be active.

These displayed quantities serve for OPS diagnosis and evaluation: lifting functions

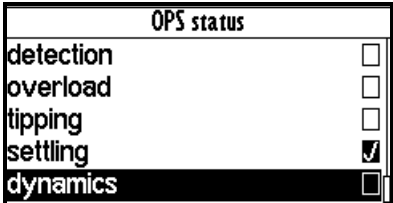
Load	854	Drive load rate evaluated from the signal Load. signal (ID 843) and related to 100% Load (ID 844). [%]
Short commands count	855	Number of forbidden short command sequences. After exceeding the short commands count, the overload switch will switch on regardless of the drive load. Short commands evaluation can be turned off by the parameter (ID 842).
OPS status	856	Indicates the status of the Overload switch block.  <p>An example of a diagnostic variable OPS status</p>

Overload of the drive will appear:

- If terms of formation of overload are met during operation. If the mode (ID 842) „**only static mode**“ is inactive during dynamic operation, when the „Load“ exceeds the value of parameter „Dynamic overload“ (ID 845) for the time longer as „Dynamic overload period“ (ID 848). Similarly, if the "Load" exceeds the static limit for the corresponding time in the static mode.
- Or if is mode (ID 842) „**test short commands**“ turned on and number of short commands in counter of short commands exceeds 5 short commands within 5 min.

Converter signals status of overload also with functional message **F36-OPS switched on.** on the display of control panel.

Overload of the drive will disappear:

If the "load" falls below the value of the parameter „Overload turn off“ (ID 847) in the reverse operation mode for the period longer as „Overload period turn off“ (ID 850).

In OPS mode (ID 842), it is possible to choose the function „**slow abseil**“. This function limits the speed to 20% in the reverse operation at overload to increase safety when handling excessive loads.

Then in the modes it is also possible to disable the internal blocking of drive start in the positive direction with the choice „**does not generate STOP**“, in cases, when only signalisation or the other action should be executed at overload (for example, the speed or torque restriction). The other actions are adjusted by using universal control blocks of converter.

Limits autodetection:

One of the new OPS modes (ID 842) is „**autodetect limits**“. Limits of overload conditions are reset after turning on this mode (ID 845, ID 846, ID 847) and during the following working cycles of the device, the limit values of parameter "Overload" are automatically detected.

The drive should be loaded with maximum safe load at this detection. (maximum permissible weight, etc). The values of limits will probably settled after 5 to 10 cycles and will stabilize at the levels that are little above the maximum working load. After turning off this mode, detected limits will remain at the new values and OPS is working within them.

Converter generates function message F37-Overload detection during „autodetect limits“.

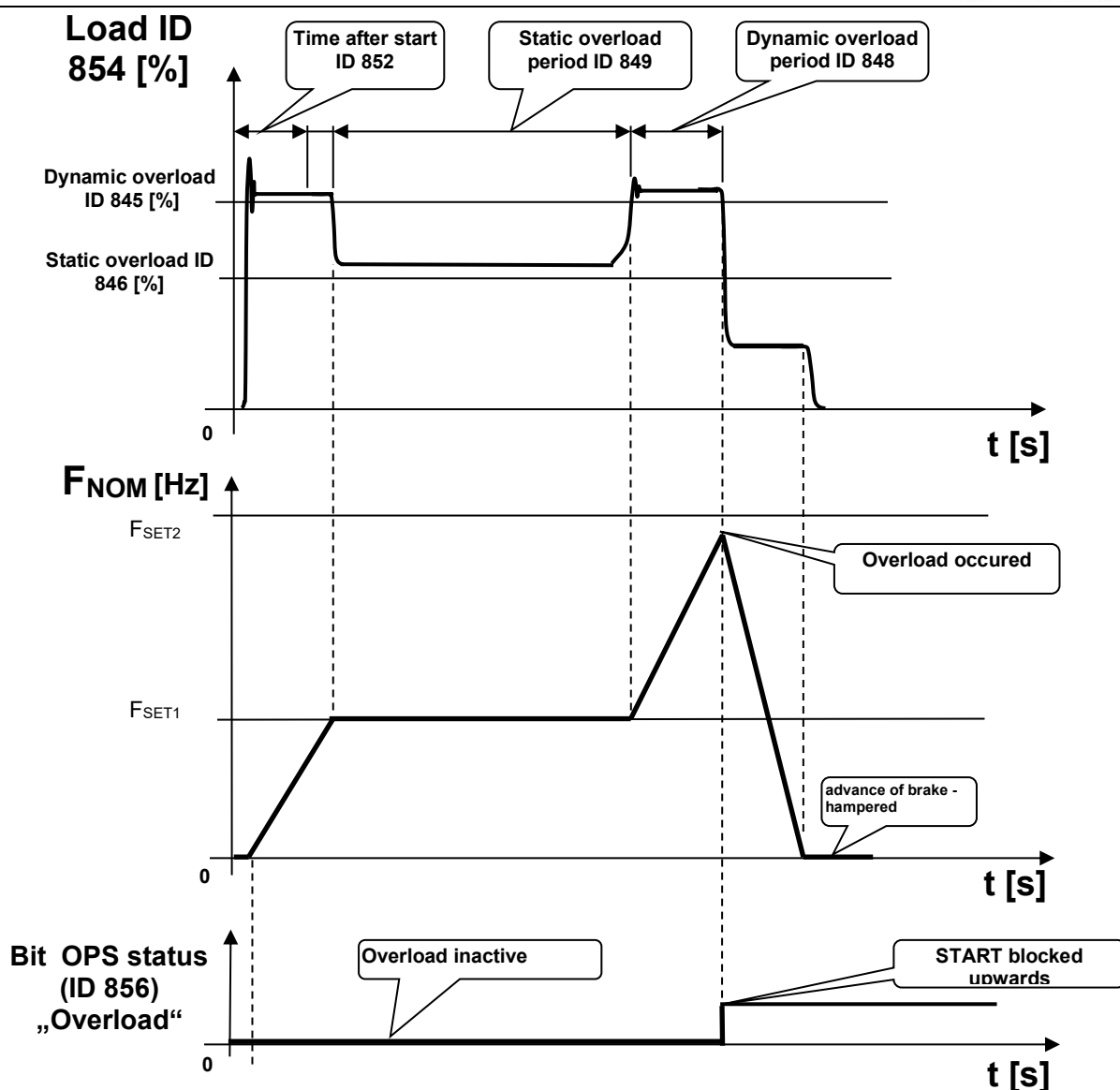

Example of overload formation in dynamic mode of operation during lifting the weight

8.13 Dynamic lift (DL) function

Crane function - **DYNAM. LIFT (DL)** (ID 1068) is used to adjust the maximum lift speed according to the actual weight. Maximum speed is reduced for higher weight.

For correct operation of the dynamic lift is necessary to set the parameters, which determine the calculation of the quantity "Load" (ID 854) as set by "Overload switch".

Parameter name	ID	Description
Load. signal	843	Selection of the parameter, which will be used as calculation source for the displayed value „Overload“.
100% Load	844	It is used to conversion to relative units. Value of the selected load signal (ID 843) that equals 100% of the load.
Load filter	851	First order filter, which is used for noise or short peaks of the selected load signal (ID 843) reduction.

Following parameters can be used to configure dynamic lift function:

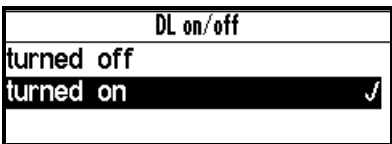
DL on/off	1069	Activation of deactivation of the dynamic lift (DL) function. 
DL measurement period	1070	Period of measurement of the static load (ID 854) on the frequency - parameter „DL frequency“ (ID 1073).
DL maximal load	1071	The upper range of the load, over which the maximum frequency is not reduced further.
DL minimal load	1072	Lower range of the load, under which dynamic lift works with the maximum allowed frequency.
DL frequency	1073	Frequency, at which the load measurement runs and frequency which represents the minimal speed that corresponds with the maximal load.

These display units serve for diagnosis and evaluation of overload switch.

Load	854	Drive load rate evaluated from the signal Load. signal (ID 843) and related to 100% Load (ID 844). [%]
OPS status	856	Static or dynamic mode detection.

Principle of operation:

When starting upwards, the frequency stops on the "DL frequency" (ID 1073) for a time "DL measurement period" (ID 1070), in order to have stabilized value of "Load" (ID 854) and then calculate new speed limit. If the load stabilizes in the interval between the "DL minimal load" (ID 1072) and "DL maximal load" (ID 1071), then the lift speed limit is calculated linearly between the "DL frequency" (ID 1073) and "Max. frequency "(ID 111).

If the lift is loaded to "DL maximal load" (ID 1071) or higher, its maximum speed will be limited to "DL frequency" (ID 1073). If the lift is loaded to „DL minimal load“ (ID 1072) or lower, its maximum speed will be limited to value of „Max. frequency“ (ID 111).

If the calculated speed limit is less than the "Max. frequency" (ID 111), converter displays a warning message "**W61-Dynamic lift**".

- A: Weight lifting with lower weight
- B: Weight lifting with a large weight

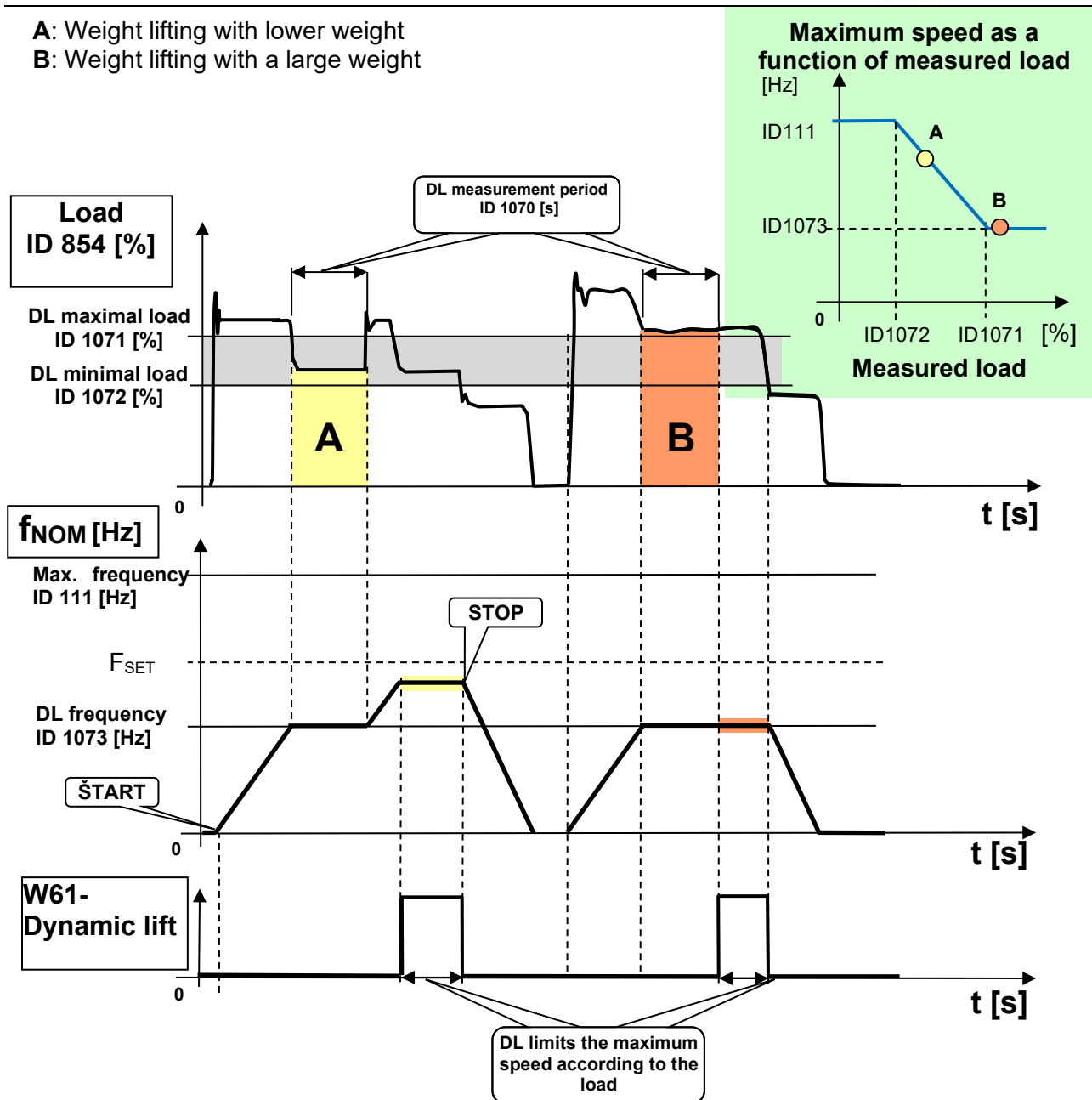

The principle of the "Dynamic lift" function.

8.14 IRC detuning function

Frequency converters UNIFREM can simultaneously evaluate the real-time signals from two incremental encoders in case of use the extension module RM_IRC_DUAL. Converter calculates the speed difference of these sensors and this difference is displayed in the parameter „Freq. IRC1-IRC2“ (ID 1086) according the formula:

$$F_{IRC1-IRC2} = | |F_{IRC1}| - |F_{IRC2}| |$$

$|F_{IRC1(2)}|$ means absolute value of the speed calculation from the values „Frequency IRC1“ (ID 434) and „Frequency IRC2“ (ID 803).

The need to derive some control actions as torque restriction, block or immediate shutdown from the detuning can occur in the multi-motor drives in practice.

For example:

- When one traction vehicle axle or bridge travers is slipping against the other
- Torque limit reduction, so the vehicle axle with less adhesion does not outrun the other
- RESET can be generated at material supply interruption and drives detuning on the rolling line (one part of the line is under load and the other no-load)
- etc.

Parameters in parameters group are used to configure „IRC detuning“ function.

Parameter ID: 1081
SETTINGS -> FUNCTIONS -> IRC1,2 DETUNING

Configuration and mode of operation:

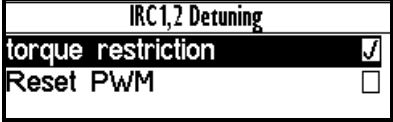
Parameter name	ID	Description
IRC1,2 Detuning	1082	Setting the operation method and the converter operation when detuning the IRC1 and IRC2 speed. 
torque restriction		IRC1, 2 detuning will cause torque restriction of motors.
reset PWM		IRC1, 2 detuning will cause immediate shutdown of motors (RESET).
Filter dIRC1,2	1083	Time constant of the IRC1 and IRC2 frequency difference filter.
Minimal IRC1,2 difference	1084	Minimal limit of the absolute value for the IRC1 and IRC2 frequency difference.
Maximal IRC1,2 difference	1085	Maximal limit of the absolute value for the IRC1 and IRC2 frequency difference.

These displayed values are used for diagnosis and evaluation:

Frequency IRC1	434	Rotor frequency defined by the rotation speed sensor from the IRC1 motor.
Frequency IRC2	803	Rotor frequency defined by the rotation speed sensor from the IRC2 motor.
Frequency IRC1-IRC2	1086	This value is filtered by the first row filter from the parameter „Filter dIRC1,2“ (ID1083).

Principle of operation:

Motor torque restriction starts to decrease when the minimal value of frequency difference "Minimal IRC1, 2 difference" (ID 1084) is exceeded, if the choice „torque restriction“ is active in the parameter „IRC1,2 Detuning“ (ID 1082). Torque is **zero** at the maximal difference "Maximal IRC1, 2 difference" (ID 1085). Shutting down the drive is smoothly proportional to detuning value. Warning „**W62 - IRC1,2 Detuning**“ is displayed during torque reduction.

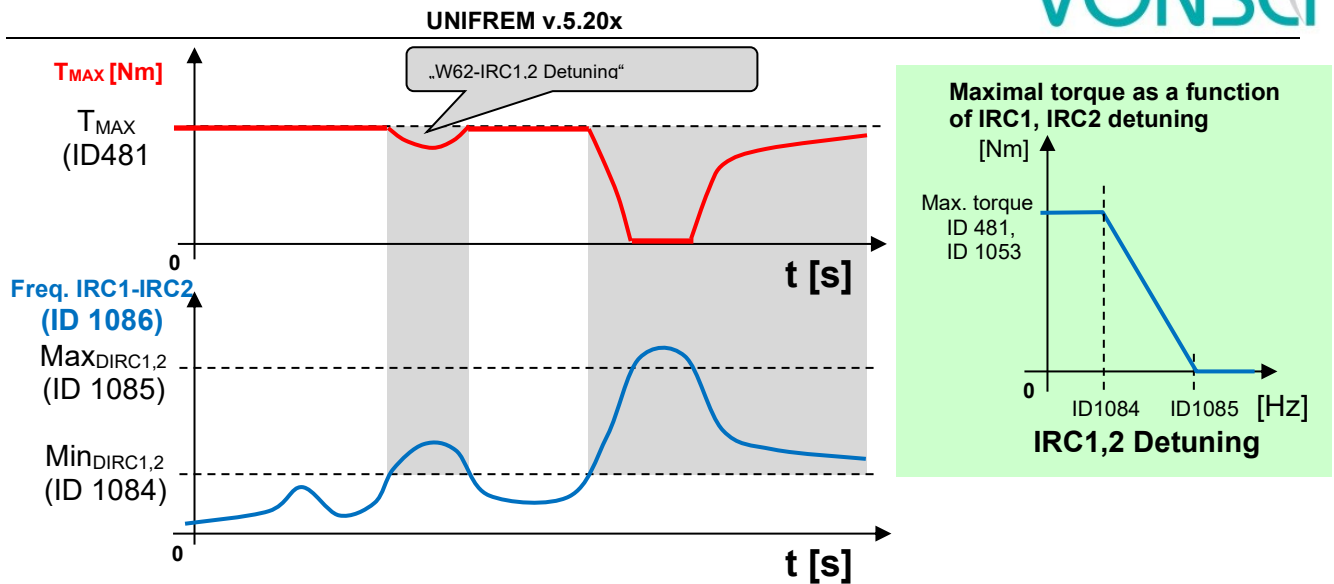

RESET PWM is generated when the maximal limit of frequency difference „Maximal IRC1,2 difference“ (ID 1085) is exceeded, if the choice „reset PWM“ is active in the parameter „IRC1,2 Detuning“ (ID 1082). “RESET PWM” expires after decrease under „Minimal IRC1,2 difference“ (ID 1084).

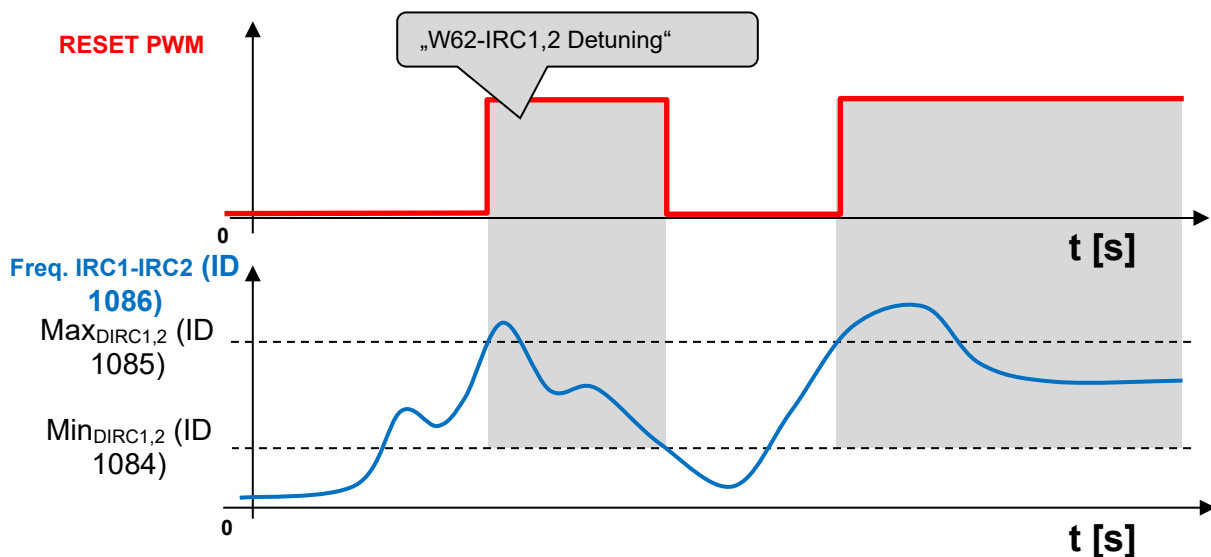

By adjustable filter „Filter dIRC1,2“ (ID 1083), short pulses of IRC can be filtered, quantization noise is damped and dynamics of torque change can be adjusted. The impact of IRC detuning to the maximal torque and to the RESET PWM too can be combined with simultaneous activation of the both options.

8.15 Using the parameter set switching for a special behavior of converter functions

UNIFREM frequency converters contain 4 user parameter sets, which can be switched and edited independently in the converter. Set switch period is currently less than 50ms. If the parameter settings are not different for parameters which block the change on-the-run (like Output phase sequence), it is possible to switch the sets during operation. The source of the set switch can be configured to any converter signal. This allows to solve special functions conditioned by changing the parameters, which individual functional blocks of the converter when using single set do not allow.



For example:

- V/f curve parameter change when changing the motor rotation direction.
- converter control sources change from the binary input (switching locally/remotely).
- controller parameter adaptivity according to the regulated frequency range.
- and many more.

Parameter set switch conditions are configured in these converter parameters:

Parameter ID: 206
SETTINGS → PAR. SETS

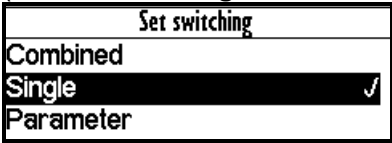
Switch set of parameters example configuration:

Parameter name	ID	Description
Set switching	657	Setting the way of switching between the sets. (Combined, Single, Parameter)  <i>Active set switching setting example</i>
Possibility to switch the active set:		SETTINGS → PAR. SETS → Set switching [657] → Parameter Option of the active set setting: Active set [205] → option choice Set 1, Set 2, Set 3, Set 4
Bit1 set source Bit2 set source Bit3 set source	641 6426 43	Setting the bits of set switch. Its function depends on the parameter Set switching [657] setting. 1.way Set switching [657] - Combined - Only the first 2 bits of the binary switch are used. Output set corresponds to the binary combination of these bits. If no bits are active, the 1 st set is active. If only 1 bit is active, the 2 nd set is active, and so on. SETTINGS → PAR. SETS → SET SWITCH Setting possibility: Bit1 set source and Bit2 set source  <i>Binary switch setting example</i> 2.way Set switching [657] – Single - Every single bit of the binary switch represents one set (bit 1 represents set 2). If more switches are active, the set with the higher sequence number is active. If no binary switch is active, the 1st set is active. SETTINGS → PAR. SETS → SET SWITCH Setting possibility: Bit1 set source, Bit2 set source, Bit3 set source  <i>Binary switch setting example</i>

<p>SPECIAL SETTING [224]</p> <p>Special functions setting for the set switches.</p>	<p>Special source of set switch setting example: SETTINGS → PAR. SETS → SET SWITCH → Bit1 set source [641]– > special</p> <table border="1" data-bbox="507 257 900 436"> <tr> <td colspan="2">MENU\SETTINGS\PAR. SETS\SET SWITCH</td> </tr> <tr> <td>Bit1 set source</td> <td>Special</td> </tr> <tr> <td>Bit2 set source</td> <td>None</td> </tr> <tr> <td>Bit3 set source</td> <td>None</td> </tr> <tr> <td colspan="2">SPECIAL SETTING</td> </tr> </table> <p>Then there is the possibility of setting SETTINGS → PAR. SETS → SET SWITCH → SPECIAL SETTING → Bit1 set signal [645] → Signal that is evaluated if the 1st bit of the binary switch is active. Either a numeric or a bit signal can be chosen.</p>	MENU\SETTINGS\PAR. SETS\SET SWITCH		Bit1 set source	Special	Bit2 set source	None	Bit3 set source	None	SPECIAL SETTING	
MENU\SETTINGS\PAR. SETS\SET SWITCH											
Bit1 set source	Special										
Bit2 set source	None										
Bit3 set source	None										
SPECIAL SETTING											

Before switch source setting of the active parameters set, it is necessary to configure the drive in the SET1 completely, it means that at deactivated set switch conditions. Then copy this setting to other sets by using commands:

MENU → SAVE / RESTORE → Sets copy

Parameter backup	
Save parameters	
Restore parameters	
Sets copy	
Parameters transfer	
Manage backups in the pa..	

Commands to copy parameter sets:

Function	Choice	Description
From set To set	Set1..Set4 Set1..Set4	Copy of the parameters from set 1..4 to the selected set 1..4. Confirm by pressing the "Copy"

Sets copy	
From set	Set 1
To set	Set 2
Copy	

At the end, it is necessary to configure the active set switch condition. If we want to use for example only two parameter sets and SET2 should be active on negative speed on the converter output (weight lowering with a different V/f curve starting voltage) Then the following parameter values are selected:

Parameter name	ID	Description
Set switching	657	Single
Bit1 set signal	645	SETTINGS → PAR. SETS → SET SWITCH → Bit1 set source [641] – > special Source of set switch choice: Status word negated [547]: SETTINGS → PAR. SETS → SET SWITCH → SPECIAL SETTING – > Bit1 set signal [645] → “MENU\ DIAGNOSTICS\ Converter state → Status word negated [547]“

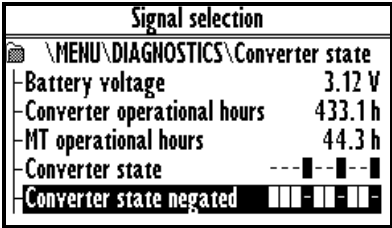
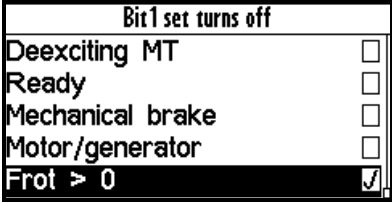
		
<p>Bit1 set switch on</p>	<p>646</p>	<p>SETTINGS → PAR. SETS → SET SWITCH → SPECIAL SETTING Bit1 set switch on [649]</p> <p>14th bit of status word is chosen „Frot > 0“.</p>  <p>(As it is the negated value of the status word, this bit has the opposite meaning Frot ≤ 0.)</p> <p>Frot – polarity of the rotor frequency. The sign of the frequency is evaluated by mathematical model if IRC is not available.</p>

We can configure the parameters in individual sets after selecting the edited. Information about which set is active is in the upper right corner of the display, written in a small font.

Using parameter sets thus contributes to increase variability of drive setting. With them, it is possible to solve:

- Asymmetry of ramp frequency
- Control mode switch
- Signals switching at the analog outputs
- Multiple motor control with the one converter
- Corrections or the other converter functions switch on or switch off
- ... etc.

9 UNIFREM Frequency converter settings examples

9.1 Process controller - PC setting to control the level height in the tank

The following section will describe how to set the converter to maintain a constant level in the tank using a pump controlled by frequency converter.

9.1.1 Situation

The frequency converter controls the speed of the pump, so that desired level of fluid in the tank is maintained. The level in the tank can range from minimal 1cm to maximal 50cm. The actual height level is sensed with level sensor with current output. Minimal level is at the value of the output 0mA and maximal level is at the value of the output 20mA. The setpoint height level is adjusted by voltage 0-10V. Minimal level corresponds to 0V and maximal level corresponds to 10V.

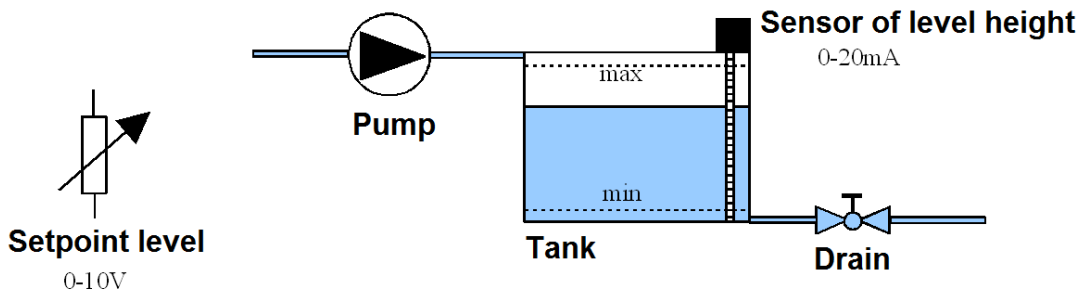

9.1.2 Converter connection

Connect the voltage for the setpoint level to the first analog input **AIN1**.

Connect the sensor of level height to the second analog input **AIN2**.

The output of the converter is connected to the pump.

9.1.3 Analog inputs setting

In the menu „SETTINGS / INPUTS AND OUTPUTS / ANALOG INPUTS“

„AIN1 – AIN1 Type“ = „0-10V“

„AIN1 – AIN1 Filter“ = 1ms (we can increase the filtration if the signal is distorted)

„AIN1 – SPECIAL SETTING – AIN1 Signal“ = none (F3)

„AIN2 – AIN2 Type“ = „0-20mA“

„AIN2 – AIN2 Filter“ = 1ms (we can increase the filtration if the signal is distorted)

„AIN2 – SPECIAL SETTING – AIN2 Signal“ = none (F3)

9.1.4 Process controller setting

In the menu „SETTINGS – FUNCTIONS – PROCESS CONTROLLER.“

„PC Mode“ = „Position“

PC Mode
Temperature
Temperature Inverse
Position
Position Inverse
Flow

Thus, the adjustment of process controller switches to the setting in units of **cm**. Option „Position Inverse“ is used for the case, if the pump is placed at the outlet of the tank and by increasing its speed, the level will decrease at a constant inflow.

The other PC modes cause the switch setting in other units.

„Min. setpoint value“ = 1cm (minimal value of the process variable).

„Max. setpoint value“ = 50cm (maximal value of the process variable).

„Source of PC setpoint“ = „AIN1“.

Source of PC setpoint	
Value	
AIN1	✓
AIN2	
AIN3	
AIN4	

If we want to set a fixed setpoint level, „Source of freq. setpoint“ = „Value“ and „Setpoint value“ = 30cm (if the desired level height is 30 cm). The value can be set only within the set limits „Min. setpoint value“ a „Max. setpoint value“

„Feedback source“ = „AIN2“.

Feedback source	
Value	
AIN1	
AIN2	✓
AIN3	
AIN4	

If fixed value is a source of the feedback, it is adjusted accordingly as the setpoint value. Obviously it is necessary to adjust corresponding constants of PID process controller.

9.1.5 Converter output setting

It is necessary to set the corresponding parameters of the the motor, ramps, V/f curve etc.

In menu „SETTINGS – COMMANDS – FREQUENCY SETPOINT“

„F reverse source [195]“ = „No reverse“. Otherwise, we would allow the pump to go into reverse mode, i.e. pump would draw off from the tank if needed.

F reverse source	
Control panel	
No reverse	✓
Permanent reverse	
BIN1	
BIN2	

V menu „SETTINGS – COMMANDS – FREQUENCY SETPOINT – Source of freq. setpoint = Special“

Source of freq. setpoint	
Process controller	
MODBUS	
PROFIBUS	
Special	✓
Maximal value	

In the menu „SETTINGS – COMMANDS – FREQUENCY SETPOINT – SPECIAL SETTING“

„Freq. setpoint signal“ = „DIAGNOSTICS – Functions – Process controller – Output PC“, this will set, that the output frequency of the converter is controlled by the process controller

S\FREQUENCY SETPOINT\SPECIAL SETTING	
Freq. setpoint ..	Output PC

9.1.6 Monitoring

In the menu „DIAGNOSTICS – Inputs / outputs – AIN“

There is possible to monitor the analog inputs either in physical units „AIN1“, „AIN2“ or in relative units „AIN1 Rel.“, „AIN2 Rel.“

In the menu „DIAGNOSTICS – Functions – Process controller“

There is possible to monitor process controller in process units.

In the menu „DIAGNOSTICS – Command – Freq. setpoint“

There is possible to monitor the recalculated process controller output to the setpoint frequency.

9.2 Example of logical blocks setting

UNIFREM frequency converters have rich possibilities of logical blocks, with logical operations setting in their software equipment: OR, AND, XOR, RS , = , >= , >.

Logical blocks inputs and outputs types setting possibility:

(**output negated**, **logical block input 1 negated**, **logical block input 2 negated**, first LB input responds to the rising edge of the signal, second LB input responds to the rising edge of the signal).

Example of logical block inputs and outputs configuration options:

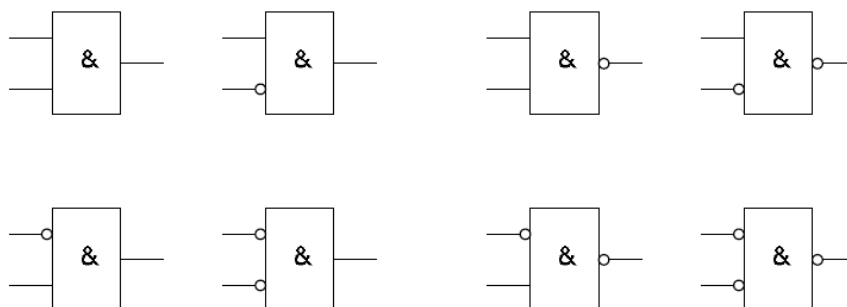

Example:

This following example demonstrates a simple example for the converter setting by using logical blocks. Asynchronous motor with power 0.37 [kW] and rated current [A] 1.05[A] is controlled. We consider the positive linear frequency ramp-up (10[s] duration) of unloaded motor from the zero frequency to the setpoint frequency of 50 [Hz]. Ramp-down of the motor is realised with linear ramp (10[s] duration) to the zero frequency.

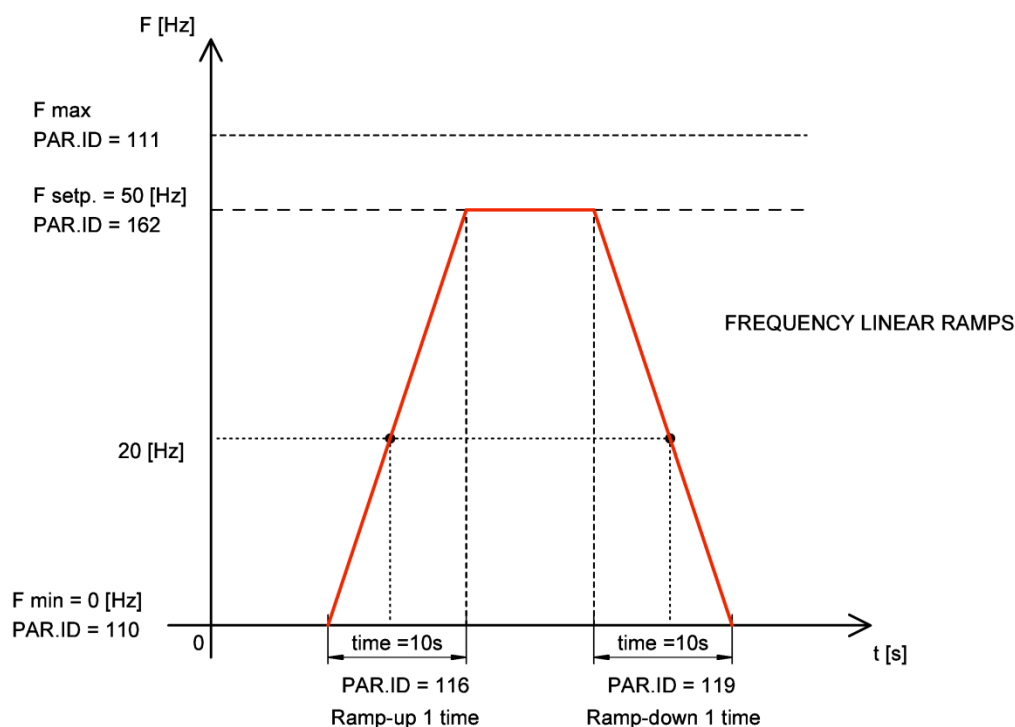

Ramp-up and ramp-down setting for this example

Converter setting by using logical blocks: The goal is to evaluate and signalize frequency 20 [Hz] crossing and not exceeding the motor current 1 [A] (motor is unloaded). Converter indicates this conditions in a special way - with analog output switching. Analog output gets character of relay output. The output of the logical block LB1 with the logical operation AND has logical value 1 over the frequency of the motor 20 [Hz] and at the motor current <1 [A]. LB1 output signal enters the second logical block LB2. Progress of the output LB2 signal (discrete states alternating of the

output signal (0.1)) is defined by the logical block LB2 with logical AND operation and switch on time $T_{on} = 0.5$ [s] and with switch off time off $T_{off} = 0.5$ [s]. The output of the LB2 logical block is connected to the analog output AOUT1. It means that at the analog output AOUT1 is the current 20[mA] when the logical block LB2 is switched on (logical value 1). On the analog output AOUT1 is the current 0[mA] when the logical block LB2 is switched off (logical value 0). The analog output is connected to the converter terminals. Signal LED lighting can be connected to the analog output AOUT1 terminals.

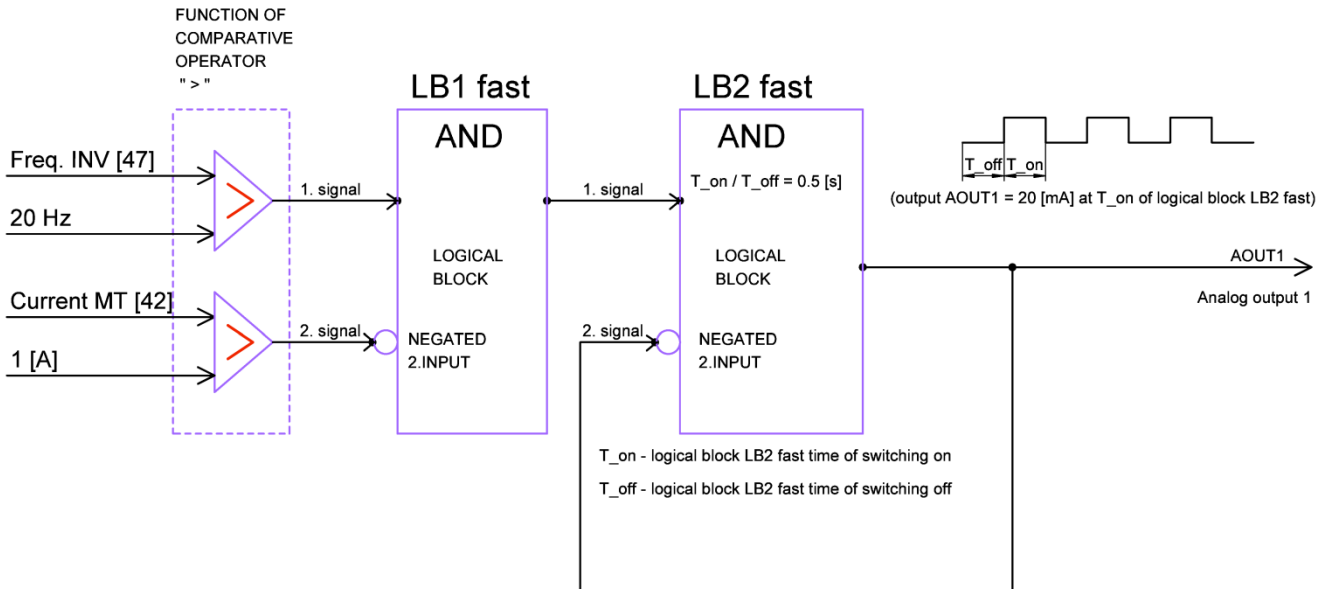

Block diagram of the evaluation of the input conditions by using logical blocks

Analog output AOUT1 and logical blocks setting:

Logical block LB1 selection and setting:

Parameter ID: 167
MENU → SETTINGS → FUNCTIONS → LOGICAL BLOCKS → LB1 (Fast)

Converter detects $\text{Freq. INV} > 20[\text{Hz}]$ and $\text{Current MT} < 1[\text{A}]$ (negated second input signal) at ramp-up to the setpoint speed. The input conditions must be valid both at once, so selection of a logical operation will be: logical product – AND.

Parameter ID: 625
MENU → SETTINGS → FUNCTIONS → LOGICAL BLOCKS → LB1 (Fast) → LB1 Operation = AND

Freq. INV signal selection (diagnostic value) for the 1st input of LB1:

Parameter ID: 577
MENU → SETTINGS → FUNCTIONS → LOGICAL BLOCKS → LB1 (Fast) → LB1_1 Signal = Freq. INV

Logical value of the LB1 first input is 1 if the signal value of **Freq. INV [47] > 20[Hz]** :

Parameter ID: 578
MENU → SETTINGS → FUNCTIONS → LOGICAL BLOCKS → LB1 (Fast) → LB1_1 switch on = 20.00 Hz

Logical value of the LB1 first input is 0 if the signal value **Freq. INV [47] < 20[Hz]** :

Parameter ID: 579
MENU → SETTINGS → FUNCTIONS → LOGICAL BLOCKS → LB1 (Fast) → LB1_1 switch off = 20.00 Hz

Current MT signal selection (diagnostic value) for the second input of LB1:

Parameter ID: 580

MENU → SETTINGS → FUNCTIONS → LOGICAL BLOCKS → LB1 (Fast) → LB1_2 Signal = Current MT

Logical value of the LB1 second input is 1 if the signal value **Current MT > 1[A]** :

Parameter ID: 581

MENU → SETTINGS → FUNCTIONS → LOGICAL BLOCKS → LB1 (Fast) → LB1_2 switch on = 1 A

Logical value of the LB1 second input is 0 if the signal value **Current MT < 1[A]**:

Parameter ID: 582

MENU → SETTINGS → FUNCTIONS → LOGICAL BLOCKS → LB1 (Fast) → LB1_2 switch off = 1 A

Second input signal of LB1 is necessary to negate to fulfill the entry condition $\text{Current MT} < 1[\text{A}]$, because the function of logical block comparative operator is “ > “.

Parameter ID: 1008

MENU → SETTINGS → FUNCTIONS → LOGICAL BLOCKS → LB1 (Fast) → LB1 Level = Input 2 negated

Logical block LB2 selection and setting:

Parameter ID: 168

MENU → SETTINGS → FUNCTIONS → LOGICAL BLOCKS → LB2 (Fast)

LB2 first input has the logical value 1 at logical value 1 of the LB1 output. Operation logical product - AND is selected for LB2 and LB2 output signal is brought to the second negated input of LB2. LB2 output switching on and off according to the set time of switch on and switch off of the LB2 logical block is achieved.

Parameter ID: 626

MENU → SETTINGS → FUNCTIONS → LOGICAL BLOCKS → LB2 (Fast) → LB2 Operation = AND

Parameter ID: 1009

MENU → SETTINGS → FUNCTIONS → LOGICAL BLOCKS → LB2 (Fast) → LB2 Level = Input 2 negated.

Signal selection for the first LB2 input:

Parameter ID: 583

MENU → SETTINGS → FUNCTIONS → LOGICAL BLOCKS → LB2 (Fast) → LB2_1 Signal = Logical blocks

Signal of first input of LB2 has the logical value 1 if the output signal of LB1 has the logical value 1:

Parameter ID: 584

MENU → SETTINGS → FUNCTIONS → LOGICAL BLOCKS → LB2 (Fast) → LB2_1 switch on = LB1

The output signal of LB2 is signal for the second negated LB2 input. We want to achieve switching on and off of the LB2 output (alternation of discrete states (0.1) with the logical block according to the set time of switch on and off of the logical block off LB2.

Parameter ID: 586

MENU → SETTINGS → FUNCTIONS → LOGICAL BLOCKS → LB2 (Fast) → LB2_2 Signal = Logical blocks

LB2 output signal is brought to the second input signal LB2

Parameter ID: 587

MENU → SETTINGS → FUNCTIONS → LOGICAL BLOCKS → LB2 (Fast) → LB2_2 switch-on = LB2

Logical block LB2 timing setting - LB2 output switching on and off.

LB2 switch time setting.

Parameter ID: 1025

MENU → SETTINGS → FUNCTIONS → LOGICAL BLOCKS → LB Timing → Switch on time 1 = 0.50 [s]

Selecting the logical block LB2 for which the defined switch ON time is applied.

Parameter ID: 1033

MENU → SETTINGS → FUNCTIONS → LOGICAL BLOCKS → LB Timing → LB for on delay 1 = LB2

LB2 switch off time setting.

Parameter ID: 1029

MENU → SETTINGS → FUNCTIONS → LOGICAL BLOCKS → LB Timing → Off delay 1 = 0.50 [s]

Selecting the logical block LB2 for which the defined switch OFF time is applied.

Parameter ID: 1037

MENU → SETTINGS → FUNCTIONS → LOGICAL BLOCKS → LB Timing → LB for off delay 1 = LB2

Analog output AOUT1 special setting:

The output of the LB2 logical block is coupled to an analog output AOUT1. Analog output of the converter AOUT1 feeds the current 20 [mA] when the logical block LB2 ($T_{on} = 0,5$ [s]) is switched on. Analog output of the converter AOUT1 feeds the current 0 [mA] when the logical block LB2 ($T_{on} = 0,5$ [s]) is switched off.

Parameter ID: 370

MENU → SETTINGS → INPUTS AND OUTPUTS → ANALOG OUTPUTS → AO1

The analog output operates in the range of 0-20 [mA]

Parameter ID: 358

MENU → SETTINGS → INPUTS AND OUTPUTS → ANALOG OUTPUTS → AO1 → AO1 Type →
0-20 [mA]

Parameter ID: 1076

MENU → SETTINGS → INPUTS AND OUTPUTS → ANALOG OUTPUTS → AO1 → AO1
 Source →
 Special

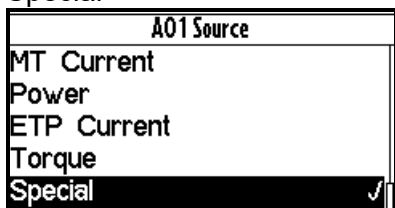

Parameter ID: 361

MENU → SETTINGS → INPUTS AND OUTPUTS → ANALOG OUTPUTS → AO1 → Sig.
 (AO1_B)
 → LB2

Parameter ID: 941

MENU → SETTINGS → INPUTS AND OUTPUTS → ANALOG OUTPUTS → AO1 → AO1_A →
 0.00 [mA]

Parameter ID: 942

MENU → SETTINGS → INPUTS AND OUTPUTS → ANALOG OUTPUTS → AO1 → AO1_B →
 20.00 [mA]

Selection of the signal that will linearly recalculate the analog output AOUT1.

Parameter ID: 359

MENU → SETTINGS → INPUTS AND OUTPUTS → ANALOG OUTPUTS → AO1 → AO1
 Signal →
 Logical blocks

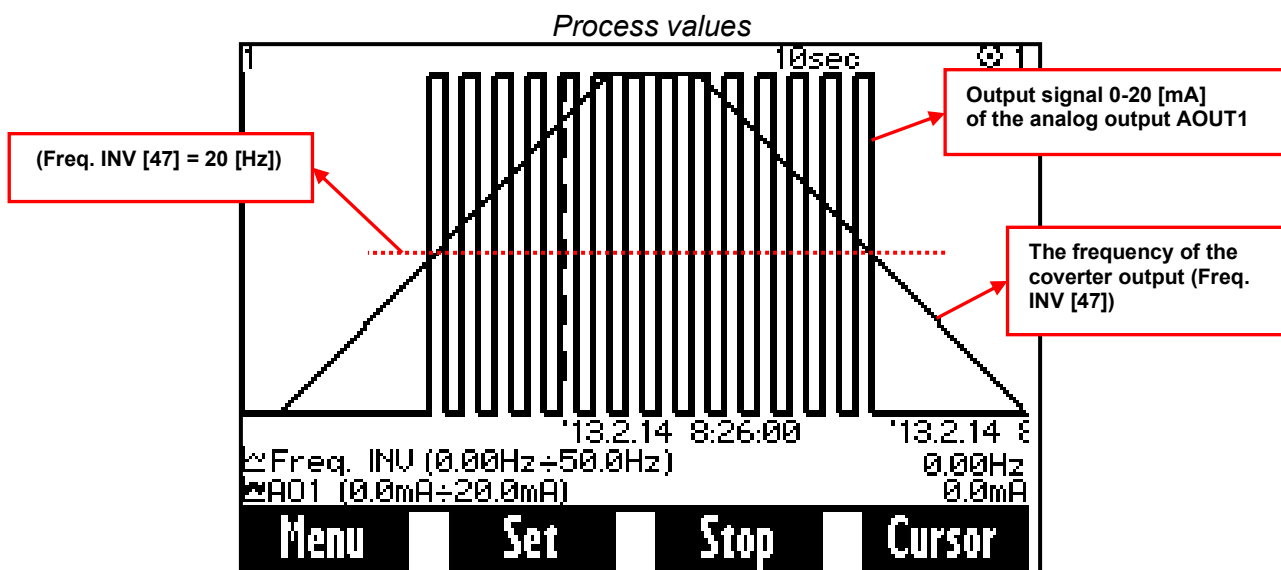

* Motor current did not exceed the value 1A during the operation





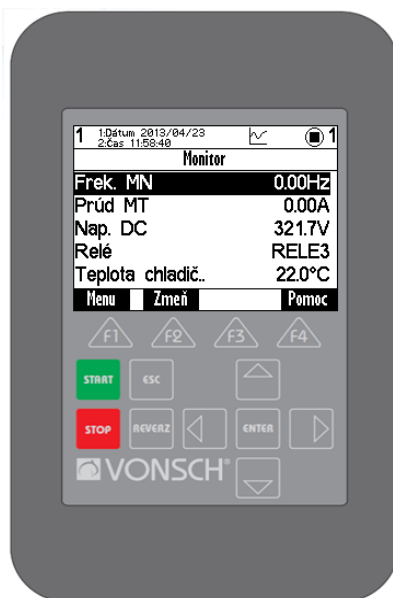

In the figure above, you can see the positive linear frequency ramp-up (10[s] duration) of unloaded motor from the zero frequency to the setpoint frequency of 50 [Hz]. Ramp-down of the motor is realised with linear ramp (10[s] duration) to the zero frequency. Compliance with conditions (motor frequency is greater than 20 [Hz] and motor current <1 [A]) is indicated by the switching of the current signal from 0 to 20 [mA] on the analog output AOUT1.

10 Control panel – Unipanel user manual

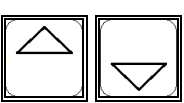
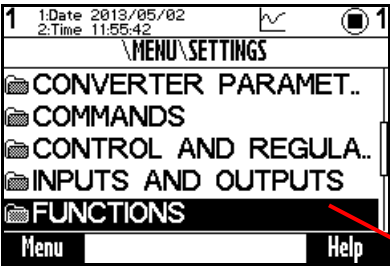
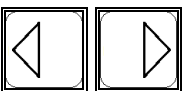

Control panel

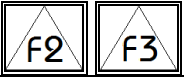
10.1 Buttons

	<p>Converter control, if control panel is selected as the control source.</p>
	<p>Change canceling, window closing, return (move up)</p>
	<p>Item selection, change confirmation</p>
	<p>Moving in the menu, value changing. In the case the folder in the MENU contains more than five items, pressing one of these keys can scroll the screen. Selected row is marked dark.</p> <div style="display: flex; align-items: center;">  <div style="margin-left: 10px;"> <p>The possibility of items scrolling</p> <p>Selected item</p> </div> </div>
	<p>Shift in menu, change of the order Setpoint value setting (Monitor window only; if control panel is selected as the setpoint source).</p>
	<p>MENU view – panel functions selection</p>
	<p>Softkeys buttons</p>
	<p>Help view</p>

10.2 Panel start

Control panel can be connected to the device that is on or off. Panel automatically turns on and connects to the device after the device is turned on. The panel will try to reconnect to the last connected device if the panel is connected to the multiple devices. Panel will show the list of available devices, if such device does not exist.





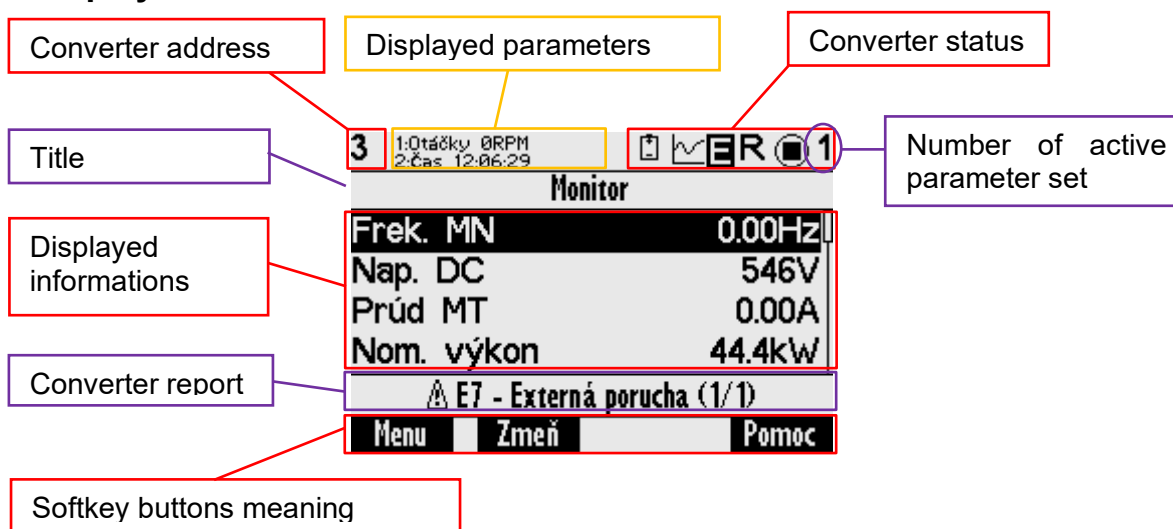

Initialization

10.3 Display



10.4 Converter status

	Weak battery in control panel (should be replaced).
	Graph record is running in panel.
	Converter is in fault – E, warnings or functional messages indication – W.
	Converter reverse is active (negative frequency).
	Converter is stopped (square), in operation (spinning target).
1, 2, 3, 4	Number of active set in converter.



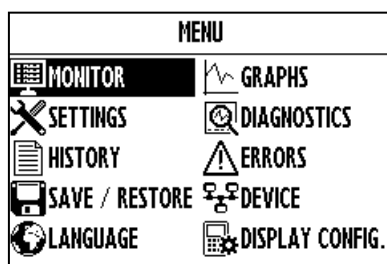





10.5 Main menu F1



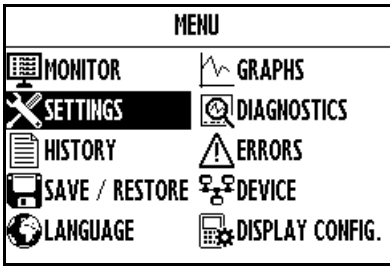
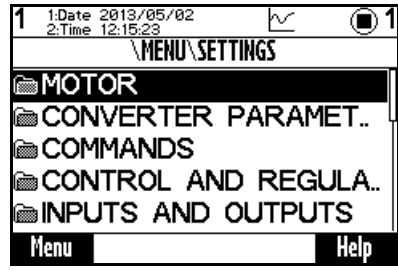

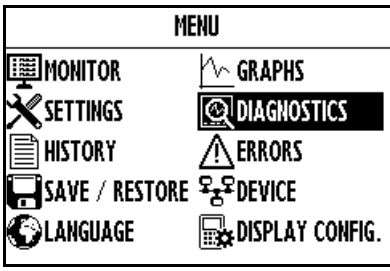
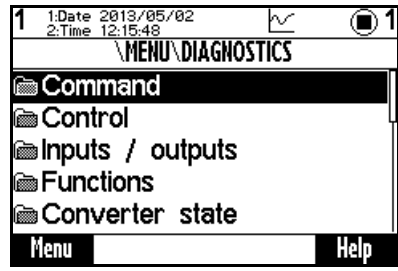

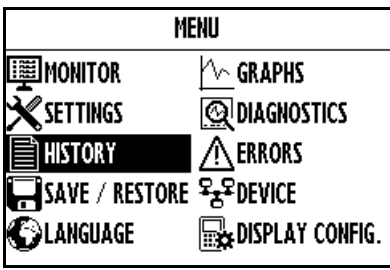
Initial menu screen

Press F1, or by using the selection arrows to toggle between MENU items. Selecting the panel function (by pressing „ENTER“)

Panel function selection

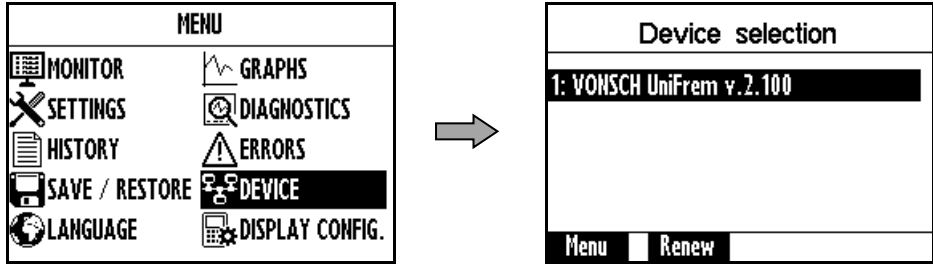
	<p>MONITOR</p>	<p>Monitor view (Monitor detail)</p> <p>Setpoint frequency setting, if control panel is selected as the setting source</p>
	<p>GRAPH</p>	<p>Signal record displaying.</p>
	<p>SETTING</p>	<p>Converter parameter setting in the tree structure. Move by using selection arrows or by using the F1 button to the SETTINGS item and confirm by pressing ENTER.</p> <div style="display: flex; align-items: center; justify-content: center;">  →  </div>
	<p>DIAGNOSTICS</p>	<p>All converter status informations displaying in the tree structure. Move by using selection arrows or by using the F1 button to the item DIAGNOSTICS and confirm by pressing ENTER.</p> <div style="display: flex; align-items: center; justify-content: center;">  →  </div>
	<p>HISTORY</p>	<p>Move by using selection arrows or by using the F1 button to the item HISTORY and confirm by pressing ENTER. Converter events (Parameters restore, parameter change..) and event history displaying (date and time of event emergence, description). After fault or event selection, recorded data at emergence will be displayed.</p> <div style="display: flex; align-items: center; justify-content: center;">  →  </div> <p>EXAMPLE:</p>

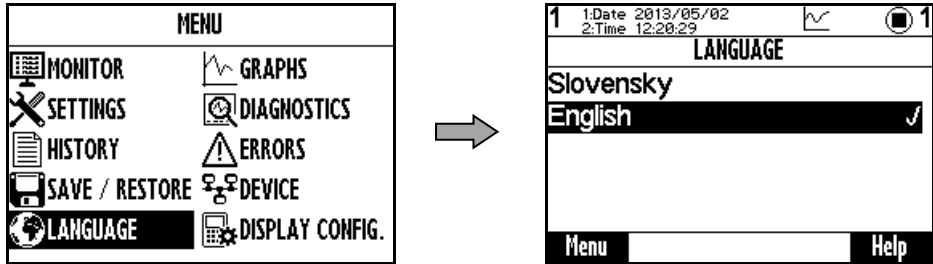
		<div style="display: flex; justify-content: space-around;"> <div style="text-align: center;"> <p><i>Recorded data at fault overcurrent</i></p> </div> <div style="text-align: center;"> <p><i>Recorded data of converter event – parameters restore</i></p> </div> </div>
	<p>ERRORS</p>	<p>Current fault and fault status view (persists, subtracting time after error, waiting to confirmation), converter warnings or functional messages. In the main MENU to confirm the selection with ENTER.</p> <div style="display: flex; justify-content: space-around; align-items: center;"> <div style="text-align: center;"> </div> <div style="font-size: 2em;">→</div> <div style="text-align: center;"> </div> </div> <p>EXAMPLE:</p> <div style="display: flex; justify-content: space-around;"> <div style="text-align: center;"> <p><i>Time is subtracting after error end</i></p> </div> <div style="text-align: center;"> <p><i>Wait for confirmation of failure</i></p> </div> </div>
	<p>SAVE / RESTORE</p>	<p>Creating and restoring backups of parameters sets. Backup management, sets copy, special partial copy.</p> <div style="display: flex; justify-content: space-around; align-items: center;"> <div style="text-align: center;"> </div> <div style="font-size: 2em;">→</div> <div style="text-align: center;"> </div> </div>
	<p>DEVICES</p>	<p>The device selection. Panel scans the bus looking for all the devices on the network. After the restart, the panel tries to connect with the last communicated coverter.</p>

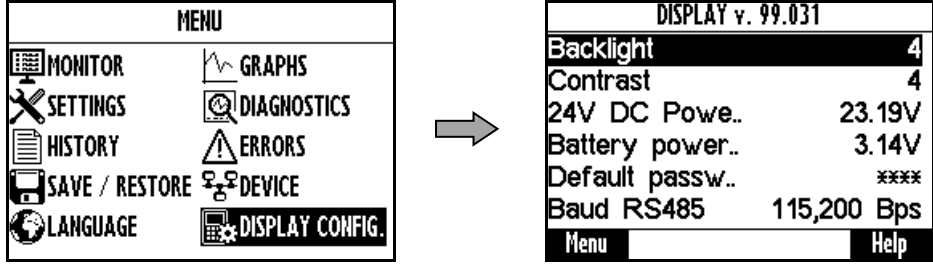
		
	<p>LANGUAGE</p>	<p>Panel communication language change. (Slovak, English).</p> 
	<p>DISPLAY CONFIG.</p>	<p>Control panel (brightness, contrast, ...) and diagnostics (supply voltage, battery voltage, ...) setting.</p> 

10.6 Monitor, monitor detail

MENU window switches to the MONITOR window after 20 seconds of inactivity, or confirm the selection MONITOR by pressing ENTER.

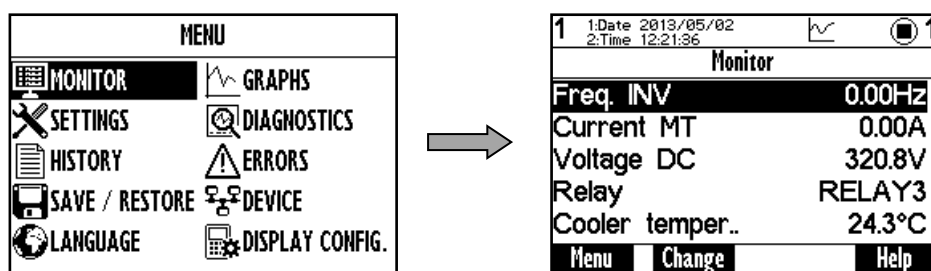

The basic window displays the selected monitored values after panel start.

	Monitor	Monitor detail
ENTER	Monitor detail will be displayed	Monitor will be displayed
ESC	Menu will be displayed	Monitor will be displayed
Change of the selected displayed value		
 Change	<p style="text-align: center;"><i>Selected value change (Selected item) -> Press F2 (Change)</i></p>	<p style="text-align: center;">EXAMPLE:</p> <p style="text-align: center;"><i>Selection of the required displayed value from the diagnostics -> to confirm ENTER</i></p>
		<p style="text-align: center;"><i>Monitor window displaying after confirmation. Dark item row = selected displayed value</i></p>

10.7 Parameters setting

Converter contains 4 sets of parameters.

Control panel offers direct set up of the parameter if the same value is set in all the sets of parameters. After parameter change confirmation, the same value is saved to all sets of parameters.

Panel offers parameter settings for each set if different value is set in sets (if the parameter value is different in at least one set), or if the parameter is marked by pressing F3 - SETS and panel will offer parameter setting for each parameter set independently.

EXAMPLE :

1. Possibility of direct setting of the selected parameters (press ENTER), because the same value is set in all 4 sets (parameter "Ramp-up break" (Id 117 = 50Hz in this example):

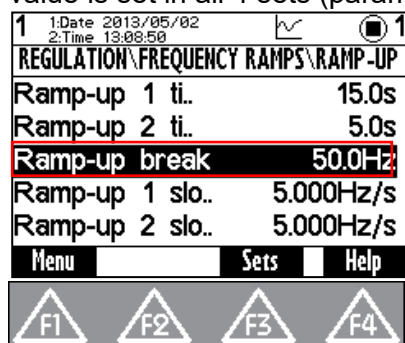

2. Parameter value setting and the same value is saved in all 4 sets after confirmation.

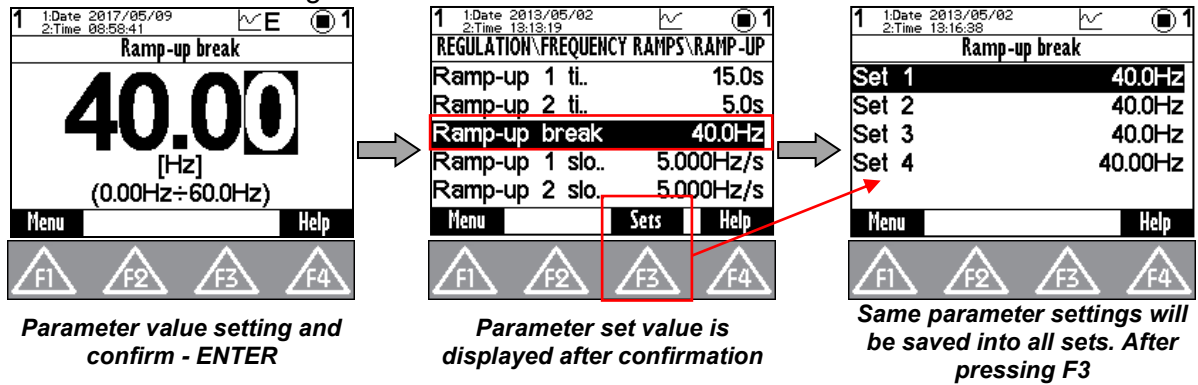

3. Panel offers parameter setting for each set if different value is set in one of the sets, or if the parameter is "open" by pressing F3 - SETS and panel will offer parameter setting for each parameter set.

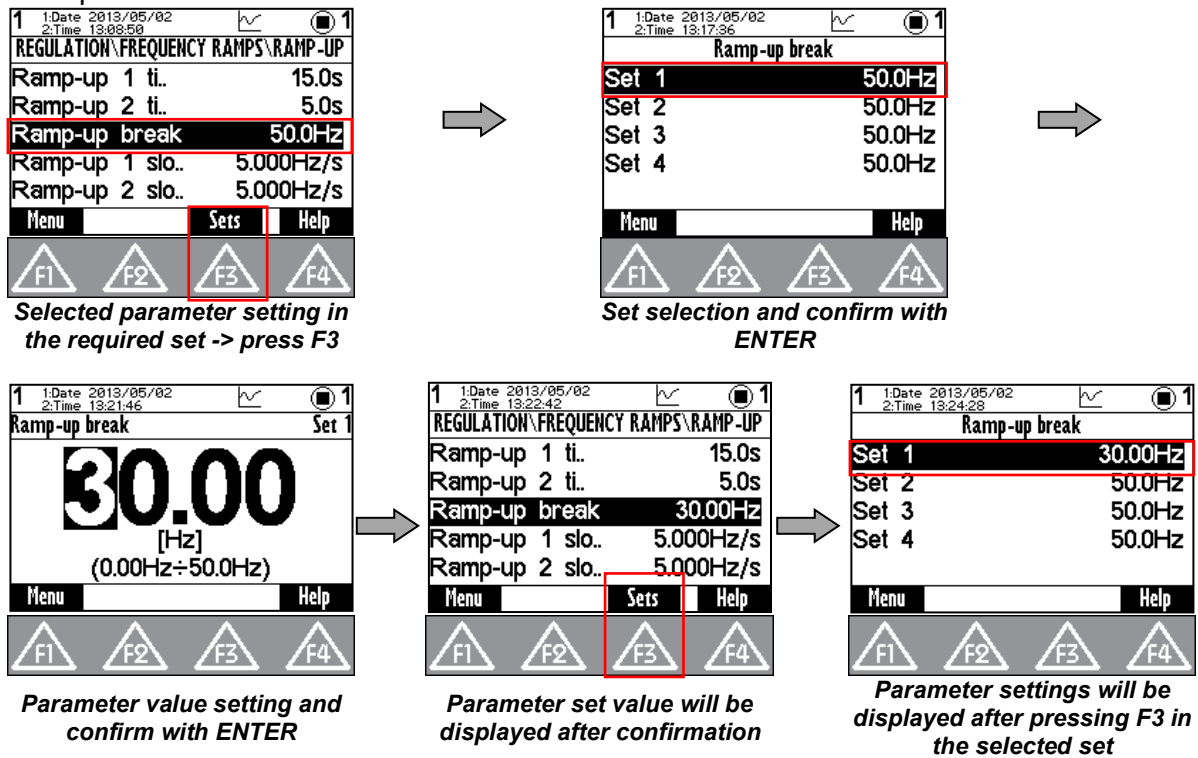

Currently unavailable parameters are displayed grey - disabled. After their selection (confirm by pressing ENTER), panel shows the parent parameter which disabled it. This also helps to make it available.

EXAMPLE:







PARAMETER "Ramp-up 1 slope (ID 124)" – Parameter is displayed grey.

After confirmation – ENTER, option to make parameter available is displayed

Transfer to the parameter to make available in the set after pressing F2

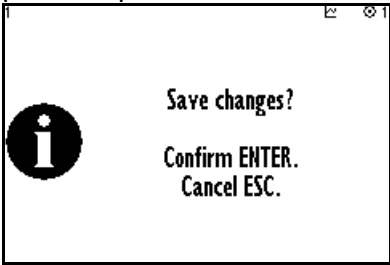
Parameters can be of different types and therefore their setting is different.

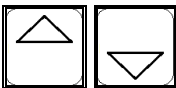
Command	Parameter group - grouping of parameters having common functionality - creates a tree structure - return to the higher level
Motor 400/0.12	Command start and execution Press the button at the selected item with the parameter type of command Execution must be confirmed by
	Numeric value setting -setpoint value setting -change of adjusted numerical order (cursor position change) The maximal and minimal possible displayed adjustable value as well as physical units of the parameter are displayed in this window. The change of the displayed engineering units (n, μ, m, k, M, G,...) is done automatically, if it is allowed by these physical units. Cursor is displayed

	on the the digit, that is currently set, if it is possible to set the parameter. If it is not possible to change the parameter, cursor is not displayed. - change will be applied immediately after confirmation
	One item selection from the list - one item has to be always selected - change will be applied immediately after confirmation
	Multiple options selection (MULTIPLE SELECTION) -no item may be selected -multiple items can be selected - selected changes are confirmed with  , where the panel requires the confirmation 
	Parameter type of signal -selection of the parameter that affects the selected action -parameter selection from the tree structure -parameter transition in the same level  -transition to the another level in the tree 

10.8 Graph

Graph parameters setting – press the  key.

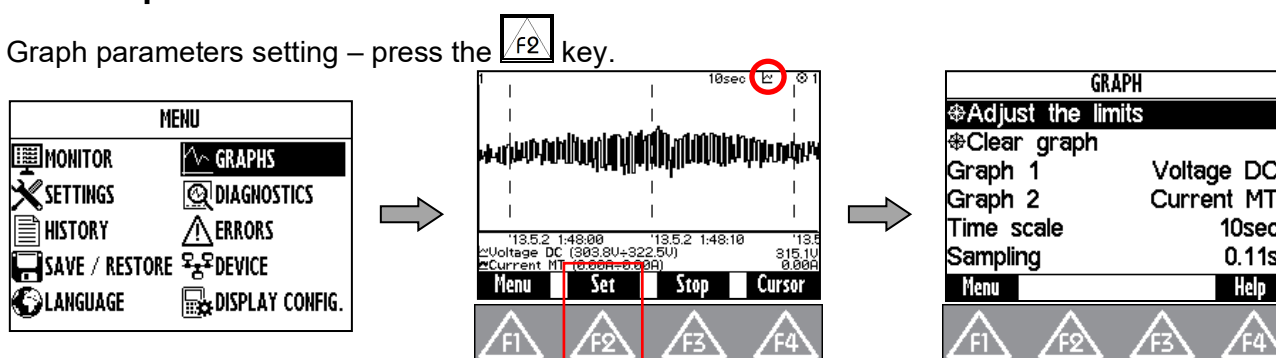

Graph window is used to record the course of values of any two parameters (quantities). Their selection can be set in graph parameters settings after pressing F2.

EXAMPLE:

Marked item (Graph 1), confirm with ENTER button. In the window - Signal selection choose the required displayed value and confirm.

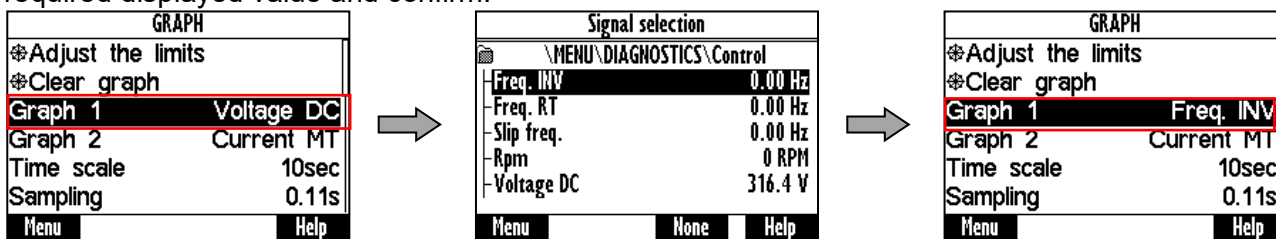

The first graph (Graph 1) is drawn with a thinner line and second graph (Graph 2) with a thicker line. The selected value, the maximum and minimum displayed value is displayed in the bottom part of the graph window on the left side and the current value is displayed on the right side of the window. The graph timestamps are displayed in the line over these variables. The value of the displayed time scale and device status is displayed in the upper part of the graph.

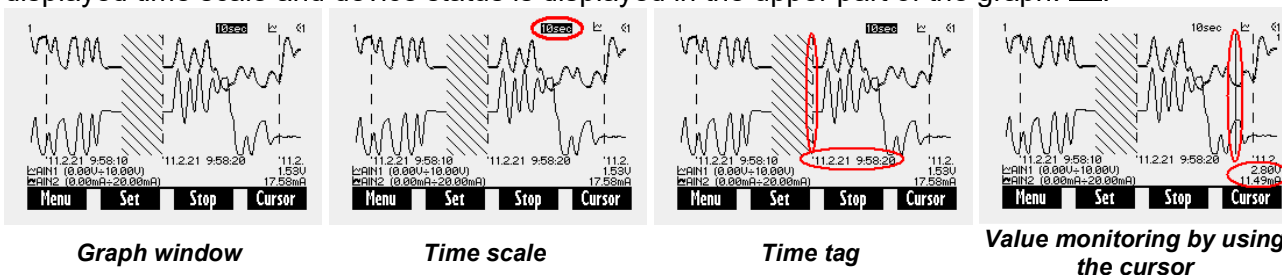

The values of selected signals are stored in the memory with a given selected step size when running the graph (F3-START). The maximum recording time is calculated from the step size. Record continues after you restart the panel (if record was running). The period of time when there is no corresponding record is filled with backslash lines. Graph record is indicated by a graph symbol in device status bar. It is possible to switch to the another window during record and the record runs normally in the background.

Start, Stop	<p>Start, stop of the record into the internal memory according to the options set</p>
Set	<p>Graph options setting Adjust the limits – set the cursor in the graph to real time. Graph will be displayed in real time Clear graph – deletes the data from the graph Graph 1, 2 – selection of the recorded signals Time scale – size of the displayed section between two timestamps. It can be changed by using arrows up and down in the graph window. Sampling – period of updating the values of selected values Record length – informs about the maximum record, that can fit into memory at the current set sampling Recording mode – determines, whether the oldest samples will be overwritten or not after filling the storage memory</p>
Cursor, Record	<p>Record – displays the last recorded signal and allows real-time record tracking Cursor – allows graph analyzing by using the cursor</p>
Shift	<p>Cursor position change in the cursor mode</p>

10.9 Parameter search

Push the button  to get help for the selected parameter. Each parameter has its own unique Id number.

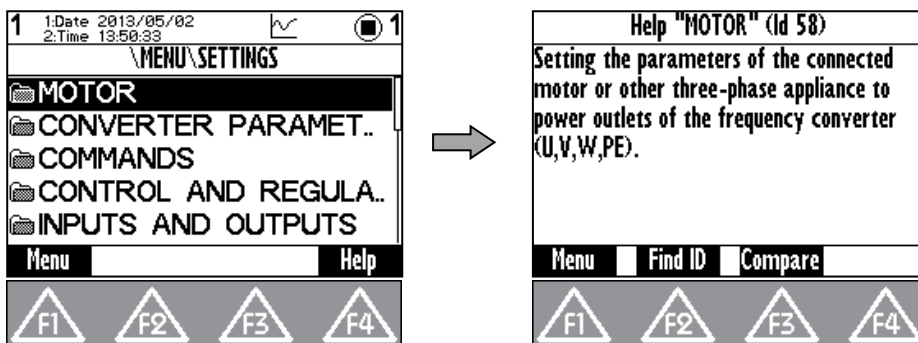

Displaying help for the selected parameter

In help window is softkey button  - Find ID. Possibility to enter Id of arbitrary parameter and the required parameter is displayed after confirmation (Press the ENTER button).

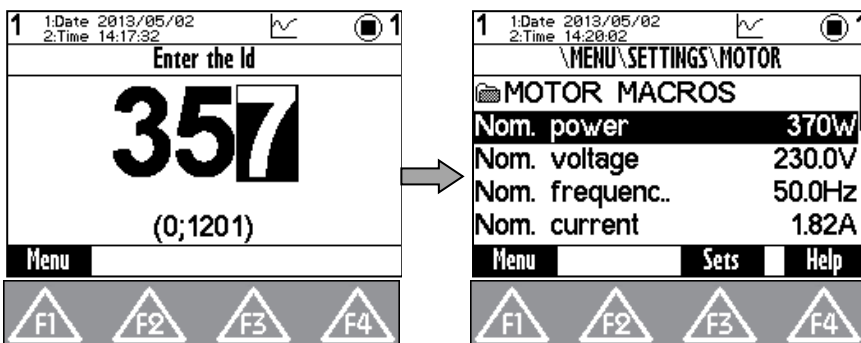

Id setting of selected parameter

Po potvrzení zobraznie požadovaného parametra

 - The button “Compare” is used to compare the setting of the selected parameter in all sets of parameters of the each stored parameter backups. This window can be used to find differences in the settings.

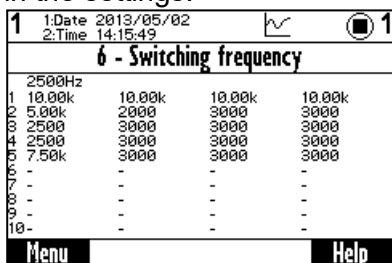

6 - Switching frequency				
	2500Hz			
1	10.00k	10.00k	10.00k	10.00k
2	5.00k	2000	3000	3000
3	2500	3000	3000	3000
4	2500	3000	3000	3000
5	7.50k	3000	3000	3000
6	-	-	-	-
7	-	-	-	-
8	-	-	-	-
9	-	-	-	-
10	-	-	-	-

10.10 Device selection for control panel

Each device is identified by its address. It is necessary to set the unique address of each device before creating a network. If the panel loses its connection with the the converter (change of its address, interruption of the cable,..), then the panel starts to search for the device again. List of devices is displayed in the format „Address of device: Device name“ after searching for available devices. Refresh the search by pressing the  button.

